

Devices and Device Controllers

- network interface
- graphics adapter
- secondary storage (disks, tape) and storage controllers
- serial (e.g., mouse, keyboard)
- sound
- co-processors
- ...

Bus Architecture Example

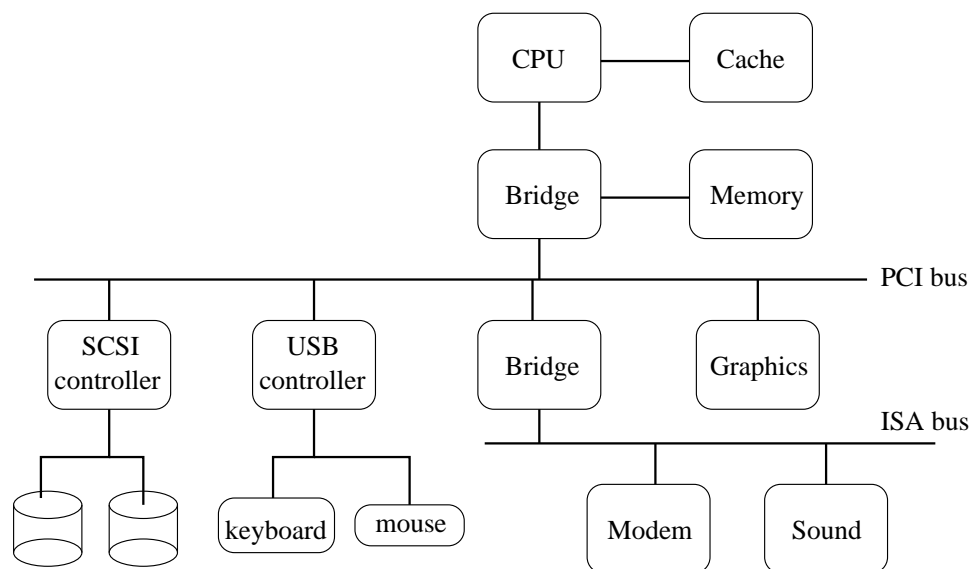

Simplified Bus Architecture

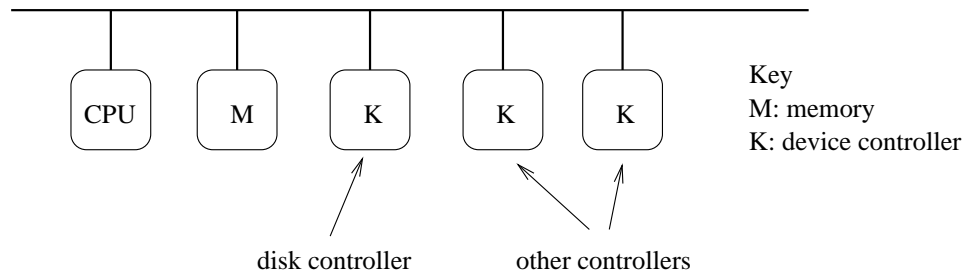

Sys/161 LAMEbus Devices

- LAMEbus controller
- timer/clock - current time, timer, beep
- disk drive - persistent storage
- serial console - character input/output
- text screen - character-oriented graphics
- network interface - packet input/output
- emulator file system - simulation-specific
- hardware trace control - simulation-specific
- random number generator

Device Interactions

- device registers
 - command, status, and data registers
 - CPU accesses register access via:
 - * special I/O instructions
 - * *memory mapping*
- interrupts
 - used by device for asynchronous notification (e.g., of request completion)
 - handled by interrupt handlers in the operating system

Example: LAMEbus timer device registers

Offset	Size	Type	Description
0	4	status	current time (seconds)
4	4	status	current time (nanoseconds)
8	4	command	restart-on-expiry (auto-restart countdown?)
12	4	status and command	interrupt (reading clears)
16	4	status and command	countdown time (microseconds)
20	4	command	speaker (causes beeps)

Sys/161 uses memory-mapping. Each device's registers are mapped into the *physical address space* of the MIPS processor.

Example: LAMEbus disk controller

Offset	Size	Type	Description
0	4	status	number of sectors
4	4	status and command	status
8	4	command	sector number
12	4	status	rotational speed (RPM)
32768	512	data	transfer buffer

MIPS/OS161 Physical Address Space

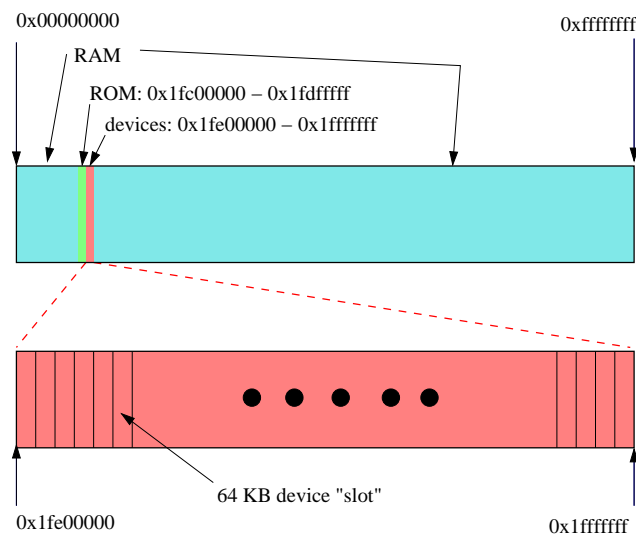

Each device is assigned to one of 32 64KB device “slots”. A device’s registers and data buffers are memory-mapped into its assigned slot.

Device Control Example: Controlling the Timer

```

/* Registers (offsets within the device slot) */
#define LT_REG_SEC    0 /* time of day: seconds */
#define LT_REG_NSEC   4 /* time of day: nanoseconds */
#define LT_REG_ROE    8 /* Restart On countdown-timer Expiry flag
#define LT_REG_IRQ    12 /* Interrupt status register */
#define LT_REG_COUNT  16 /* Time for countdown timer (usec) */
#define LT_REG_SPKR   20 /* Beep control */

/* Get the number of seconds from the lamebus timer */
/* lt->lt_buspos is the slot number of the target device */
secs = bus_read_register(lt->lt_bus, lt->lt_buspos,
    LT_REG_SEC);

/* Get the timer to beep. Doesn't matter what value is sent */
bus_write_register(lt->lt_bus, lt->lt_buspos,
    LT_REG_SPKR, 440);

```

Device Control Example: Address Calculations

```

/* LAMEbus mapping size per slot */
#define LB_SLOT_SIZE    65536
#define MIPS_KSEG1     0xa0000000
#define LB_BASEADDR    (MIPS_KSEG1 + 0x1fe00000)

/* Compute the virtual address of the specified offset */
/* into the specified device slot */
void *
lamebus_map_area(struct lamebus_softc *bus, int slot, u_int32_t offset)
{
    u_int32_t address;
    (void)bus; // not needed

    assert(slot >= 0 && slot < LB_NSLOTS);
    address = LB_BASEADDR + slot * LB_SLOT_SIZE + offset;
    return (void *)address;
}

```

Device Control Example: Commanding the Device

```
/* FROM: kern/arch/mips/mips/lamebus_mips.c */
/* Read 32-bit register from a LAMEbus device. */
u_int32_t
lamebus_read_register(struct lamebus_softc *bus,
    int slot, u_int32_t offset)
{
    u_int32_t *ptr = lamebus_map_area(bus, slot, offset);
    return *ptr;
}

/* Write a 32-bit register of a LAMEbus device. */
void
lamebus_write_register(struct lamebus_softc *bus,
    int slot, u_int32_t offset, u_int32_t val)
{
    u_int32_t *ptr = lamebus_map_area(bus, slot, offset);
    *ptr = val;
}
```

Device Data Transfer

- Sometimes, a device operation will involve a large chunk of data - much larger than can be moved with a single instruction. Example: reading a block of data from a disk.
- Devices may have data buffers for such data - but how to get the data between the device and memory?
- If the data buffer is memory-mapped, the kernel can move the data iteratively, one word at a time. This is called *program-controlled I/O*.
- Program controlled I/O is simple, but it means that the CPU is *busy executing kernel code* while the data is being transferred.
- The alternative is called Direct Memory Access (DMA). During a DMA data transfer, the CPU is *not busy* and is free to do something else, e.g., run an application.

Sys/161 LAMEbus devices do program-controlled I/O.

Direct Memory Access (DMA)

- DMA is used for block data transfers between devices (e.g., a disk controller) and memory
- Under DMA, the CPU initiates the data transfer and is notified when the the transfer is finished. However, the device (not the CPU) controls the transfer itself.

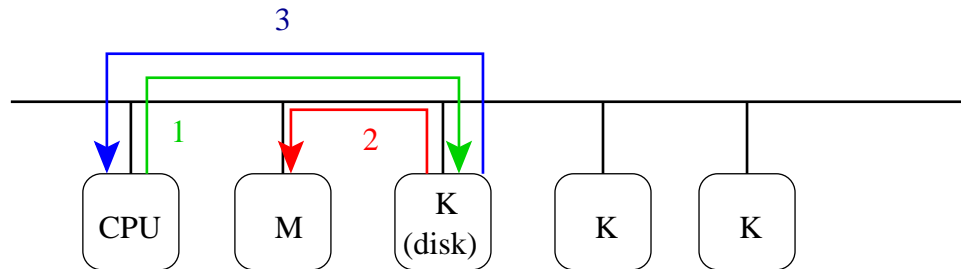

1. CPU issues DMA request to controller
2. controller directs data transfer
3. controller interrupts CPU

Applications and Devices

- interaction with devices is normally accomplished by device drivers in the OS, so that the OS can control how the devices are used
- applications see a simplified view of devices through a system call interface (e.g., block vs. character devices in Unix)
 - the OS may provide a system call interface that permits low level interaction between application programs and a device
- operating system often *buffers* data that is moving between devices and application programs' address spaces
 - benefits: solve timing, size mismatch problems
 - drawback: performance

Logical View of a Disk Drive

- disk is an array of numbered blocks (or sectors)
- each block is the same size (e.g., 512 bytes)
- blocks are the unit of transfer between the disk and memory
 - typically, one or more contiguous blocks can be transferred in a single operation
- storage is *non-volatile*, i.e., data persists even when the device is without power

A Disk Platter's Surface

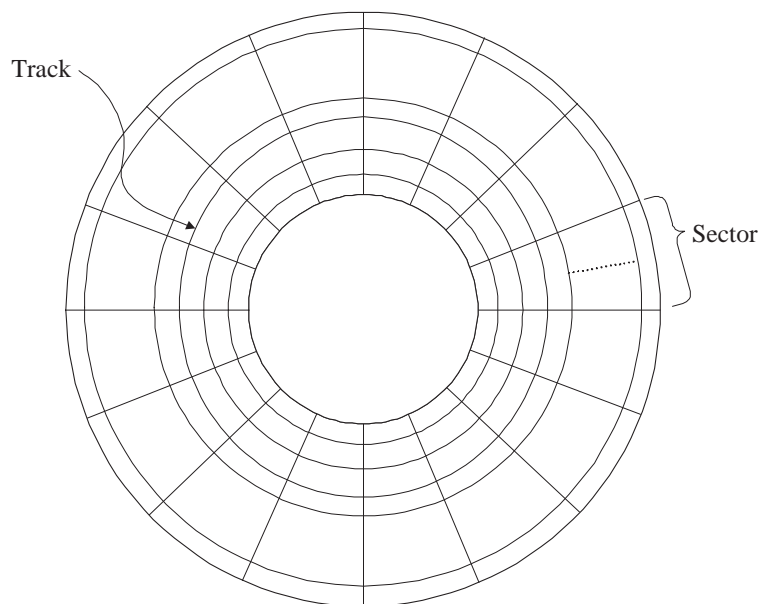

Physical Structure of a Disk Drive

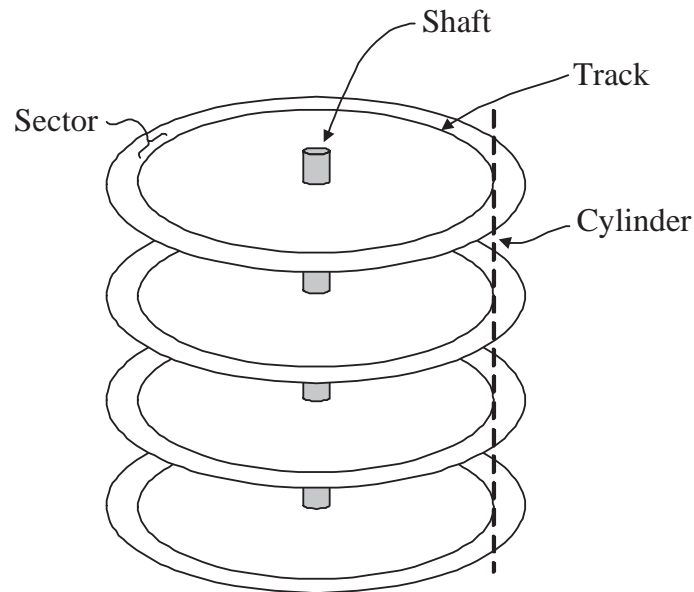

Simplified Cost Model for Disk Block Transfer

- moving data to/from a disk involves:
 - seek time:** move the read/write heads to the appropriate cylinder
 - rotational latency:** wait until the desired sectors spin to the read/write heads
 - transfer time:** wait while the desired sectors spin past the read/write heads
- request service time is the sum of seek time, rotational latency, and transfer time

$$t_{service} = t_{seek} + t_{rot} + t_{transfer}$$

- note that there are other overheads but they are typically small relative to these three

Rotational Latency and Transfer Time

- rotational latency depends on the rotational speed of the disk
- if the disk spins at ω rotations per second:

$$0 \leq t_{rot} \leq \frac{1}{\omega}$$

- expected rotational latency:

$$\bar{t}_{rot} = \frac{1}{2\omega}$$

- transfer time depends on the rotational speed and on the amount of data transferred
- if k sectors are to be transferred and there are T sectors per track:

$$t_{transfer} = \frac{k}{T\omega}$$

Seek Time

- seek time depends on the speed of the arm on which the read/write heads are mounted.
- a simple linear seek time model:
 - $t_{maxseek}$ is the time required to move the read/write heads from the innermost cylinder to the outermost cylinder
 - C is the total number of cylinders
- if k is the required *seek distance* ($k > 0$):

$$t_{seek}(k) = \frac{k}{C} t_{maxseek}$$

Performance Implications of Disk Characteristics

- larger transfers to/from a disk device are *more efficient* than smaller ones. That is, the cost (time) per byte is smaller for larger transfers. (Why?)
- sequential I/O is faster than non-sequential I/O
 - sequential I/O operations eliminate the need for (most) seeks
 - disks use other techniques, like *track buffering*, to reduce the cost of sequential I/O even more

Disk Head Scheduling

- goal: reduce seek times by controlling the order in which requests are serviced
- disk head scheduling may be performed by the controller, by the operating system, or both
- for disk head scheduling to be effective, there must be a queue of outstanding disk requests (otherwise there is nothing to reorder)
- an on-line approach is required: the disk request queue is not static

FCFS Disk Head Scheduling

- handle requests in the order in which they arrive
- fair and simple, but no optimization of seek times

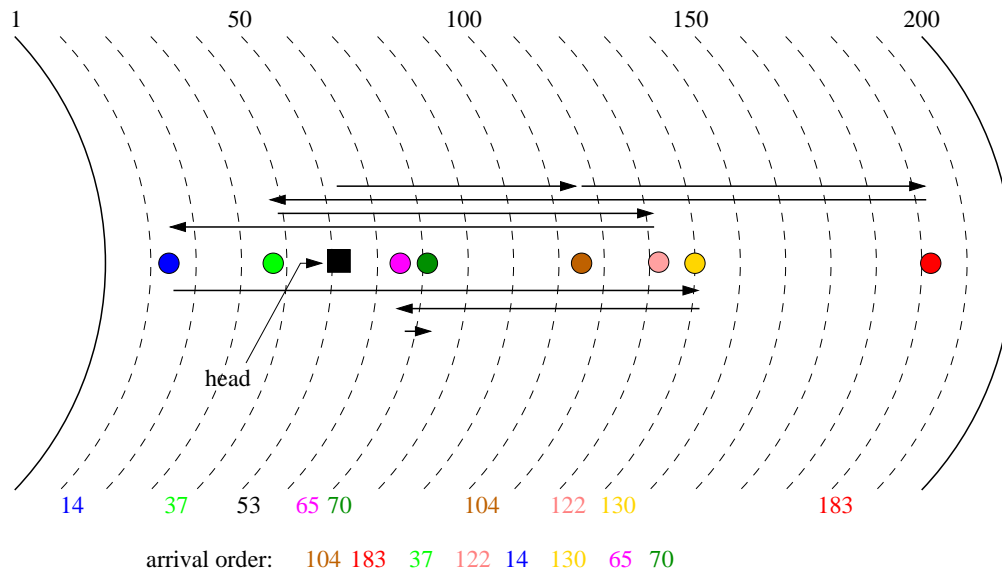

Shortest Seek Time First (SSTF)

- choose closest request (a greedy approach)
- seek times are reduced, but requests may starve

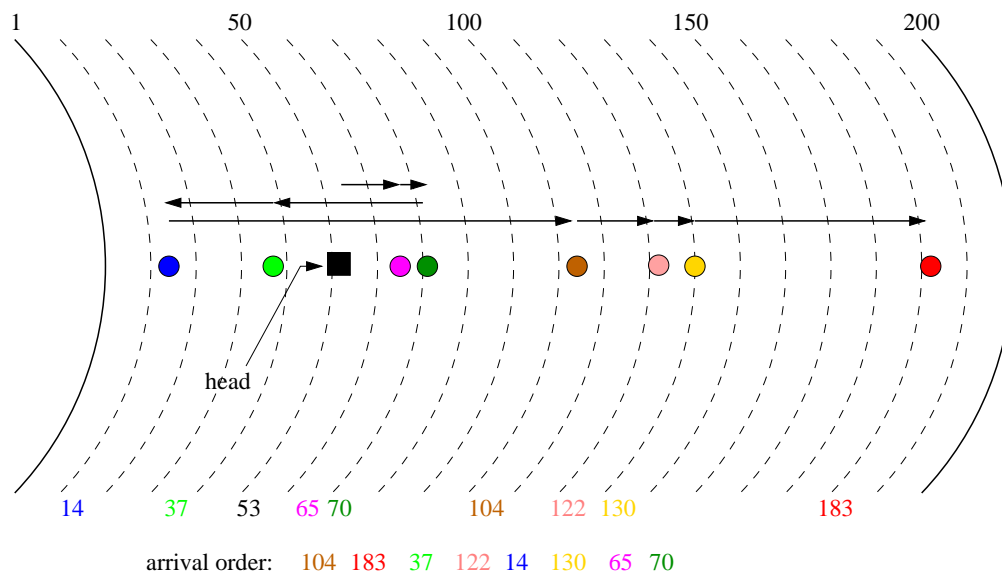

SCAN and LOOK

- LOOK is the commonly-implemented variant of SCAN. Also known as the “elevator” algorithm.
- Under LOOK, the disk head moves in one direction until there are no more requests in front of it, then reverses direction.
- seek time reduction without starvation
- SCAN is like LOOK, except the read/write heads always move all the way to the edge of the disk in each direction.

SCAN Example

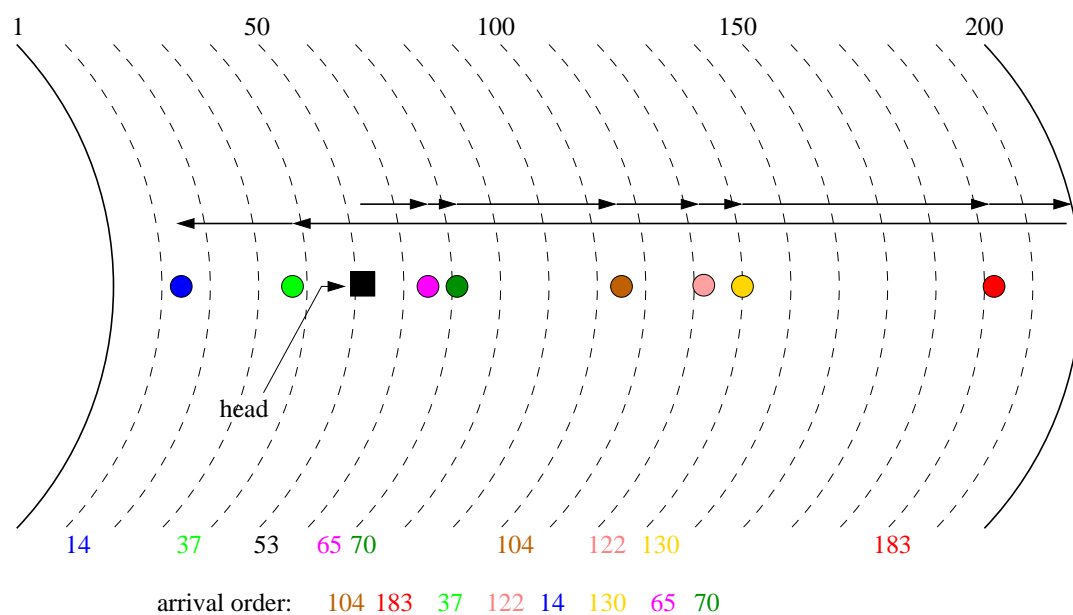

Circular SCAN (C-SCAN) and Circular LOOK (C-LOOK)

- C-LOOK and C-SCAN are variants of LOOK and SCAN
- Under C-LOOK, the disk head moves in one direction until there are no more requests in front of it, then it jumps back and begins another scan in the same direction as the first.
- C-LOOK avoids bias against “edge” cylinders

C-LOOK Example

