

Interprocess Communication Mechanisms

- shared storage
 - These mechanisms have already been covered. examples:
 - * shared virtual memory
 - * shared files
 - processes must agree on a name (e.g., a file name, or a shared virtual memory key) in order to establish communication
- message based
 - signals
 - sockets
 - pipes
 - ...

Message Passing

Indirect Message Passing

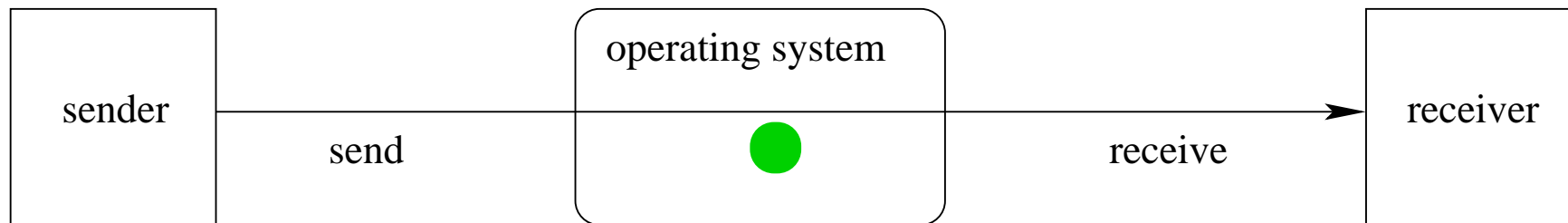
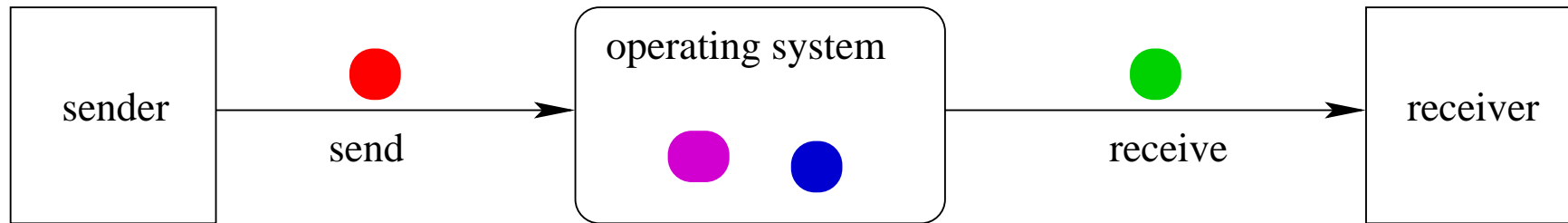

Direct Message Passing

If message passing is indirect, the message passing system must have some capacity to buffer (store) messages.

Properties of Message Passing Mechanisms

Addressing: how to identify where a message should go

Directionality:

- simplex (one-way)
- duplex (two-way)
- half-duplex (two-way, but only one way at a time)

Message Boundaries:

datagram model: message boundaries

stream model: no boundaries

Properties of Message Passing Mechanisms (cont'd)

Connections: need to connect before communicating?

- in connection-oriented models, recipient is specified at time of connection, not by individual send operations. All messages sent over a connection have the same recipient.
- in connectionless models, recipient is specified as a parameter to each send operation.

Reliability:

- can messages get lost?
- can messages get reordered?
- can messages get damaged?

Sockets

- a socket is a communication *end-point*
- if two processes are to communicate, each process must create its own socket
- two common types of sockets
 - stream sockets:** support connection-oriented, reliable, duplex communication under the stream model (no message boundaries)
 - datagram sockets:** support connectionless, best-effort (unreliable), duplex communication under the datagram model (message boundaries)
- both types of sockets also support a variety of address domains, e.g.,
 - Unix domain:** useful for communication between processes running on the same machine
 - INET domain:** useful for communication between process running on different machines that can communicate using IP protocols.

Using Datagram Sockets (Receiver)

```
s = socket(addressType, SOCK_DGRAM);  
bind(s, address);  
recvfrom(s, buf, bufLength, sourceAddress);  
...  
close(s);
```

- `socket` creates a socket
- `bind` assigns an address to the socket
- `recvfrom` receives a message from the socket
 - `buf` is a buffer to hold the incoming message
 - `sourceAddress` is a buffer to hold the address of the message sender
- both `buf` and `sourceAddress` are filled by the `recvfrom` call

Using Datagram Sockets (Sender)

```
s = socket(addressType, SOCK_DGRAM);  
sendto(s, buf, msgLength, targetAddress)  
...  
close(s);
```

- `socket` creates a socket
- `sendto` sends a message using the socket
 - `buf` is a buffer that contains the message to be sent
 - `msgLength` indicates the length of the message in the buffer
 - `targetAddress` is the address of the socket to which the message is to be delivered

More on Datagram Sockets

- `sendto` and `recvfrom` calls *may* block
 - `recvfrom` blocks if there are no messages to be received from the specified socket
 - `sendto` blocks if the system has no more room to buffer undelivered messages
- datagram socket communications are (in general) unreliable
 - messages (datagrams) may be lost
 - messages may be reordered
- The sending process must know the address of the receive process's socket. How does it know this?

A Socket Address Convention

Service	Port	Description
echo	7/udp	
systat	11/tcp	
netstat	15/tcp	
chargen	19/udp	
ftp	21/tcp	
ssh	22/tcp	# SSH Remote Login Protocol
telnet	23/tcp	
smtp	25/tcp	
time	37/udp	
gopher	70/tcp	# Internet Gopher
finger	79/tcp	
www	80/tcp	# WorldWideWeb HTTP
pop2	109/tcp	# POP version 2
imap2	143/tcp	# IMAP

Using Stream Sockets (Passive Process)

```
s = socket(addressType, SOCK_STREAM);  
bind(s, address);  
listen(s, backlog);  
ns = accept(s, sourceAddress);  
recv(ns, buf, bufLength);  
send(ns, buf, bufLength);  
...  
close(ns); // close accepted connection  
close(s); // don't accept more connections
```

- `listen` specifies the number of connection requests for this socket that will be queued by the kernel
- `accept` accepts a connection request and creates a new socket (`ns`)
- `recv` receives up to `bufLength` bytes of data from the connection
- `send` sends `bufLength` bytes of data over the connection.

Notes on Using Stream Sockets (Passive Process)

- `accept` creates a new socket (`ns`) for the new connection
- `sourceAddress` is an address buffer. `accept` fills it with the address of the socket that has made the connection request
- additional connection requests can be accepted using more `accept` calls on the original socket (`s`)
- `accept` blocks if there are no pending connection requests
- connection is duplex (both `send` and `recv` can be used)

Using Stream Sockets (Active Process)

```
s = socket(addressType, SOCK_STREAM);  
connect(s, targetAddress);  
send(s, buf, bufLength);  
recv(s, buf, bufLength);  
...  
close(s);
```

- `connect` sends a connection request to the socket with the specified address
 - `connect` blocks until the connection request has been accepted
- active process may (optionally) bind an address to the socket (using `bind`) before connecting. This is the address that will be returned by the `accept` call in the passive process
- if the active process does not choose an address, the system will choose one

Illustration of Stream Socket Connections

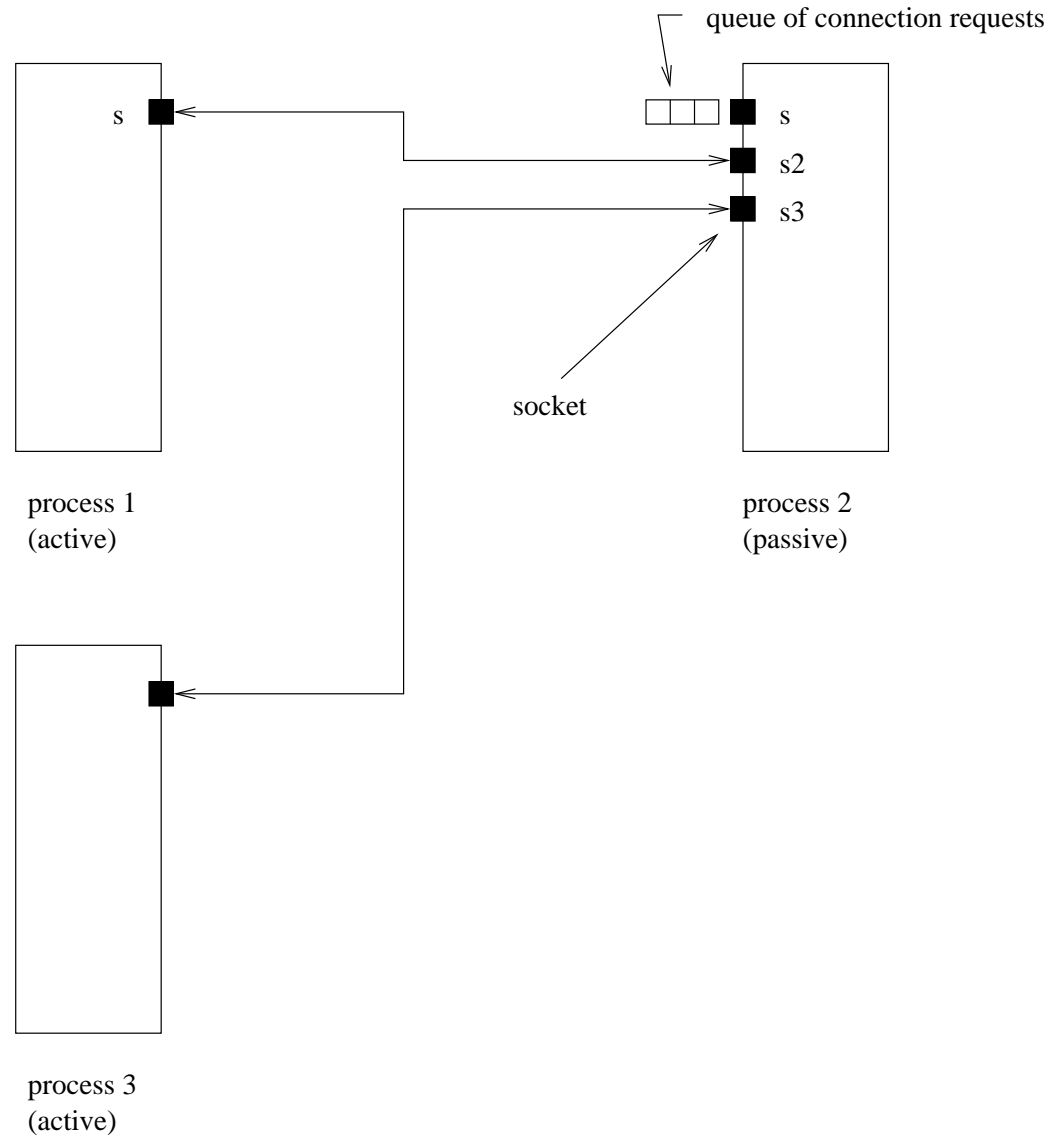

Pipes

- pipes are communication objects (not end-points)
- pipes use the stream model and are connection-oriented and reliable
- some pipes are simplex, some are duplex
- pipes use an implicit addressing mechanism that limits their use to communication between *related* processes, typically a child process and its parent
- a `pipe()` system call creates a pipe and returns two descriptors, one for each end of the pipe
 - for a simplex pipe, one descriptor is for reading, the other is for writing
 - for a duplex pipe, both descriptors can be used for reading and writing

One-way Child/Parent Communication Using a Simplex Pipe

```
int fd[2];
char m[] = "message for parent";
char y[100];
pipe(fd); // create pipe
pid = fork(); // create child process
if (pid == 0) {
    // child executes this
    close(fd[0]); // close read end of pipe
    write(fd[1],m,19);
    ...
} else {
    // parent executes this
    close(fd[1]); // close write end of pipe
    read(fd[0],y,100);
    ...
}
```

Illustration of Example (after `pipe()`)

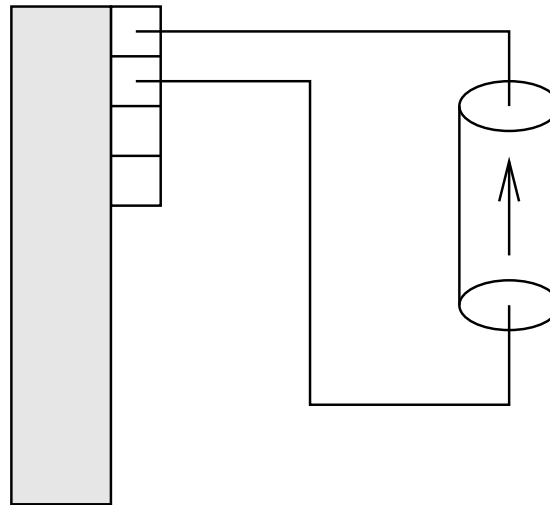

parent process

Illustration of Example (after `fork()`)

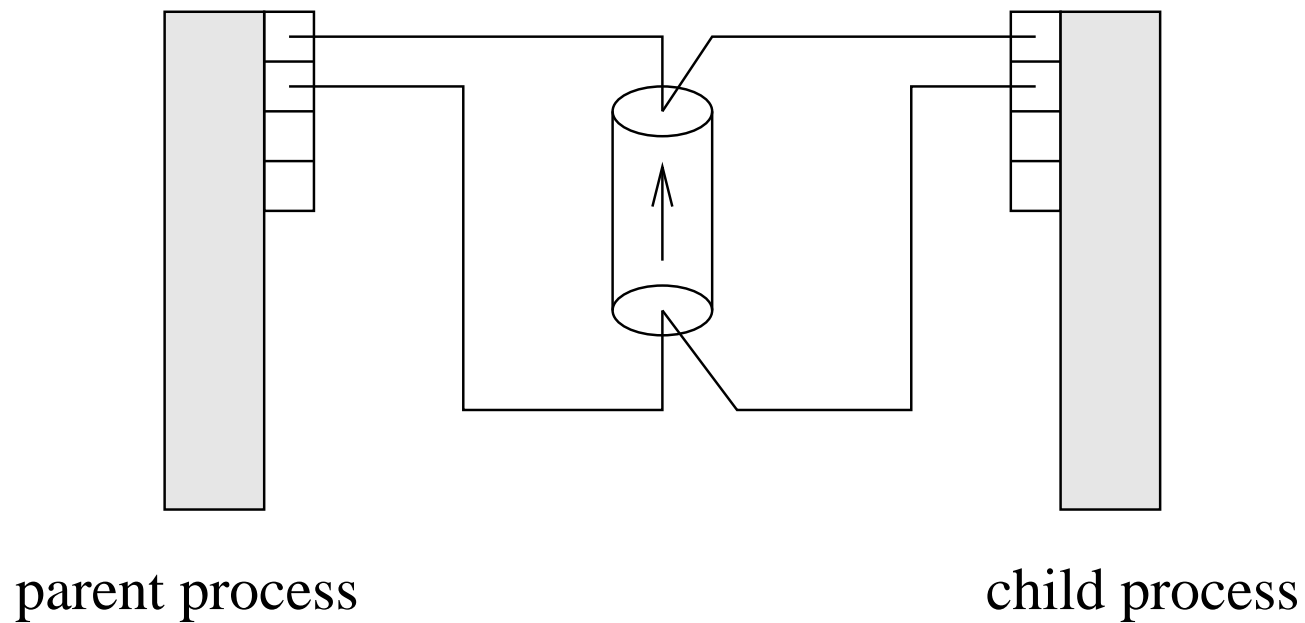
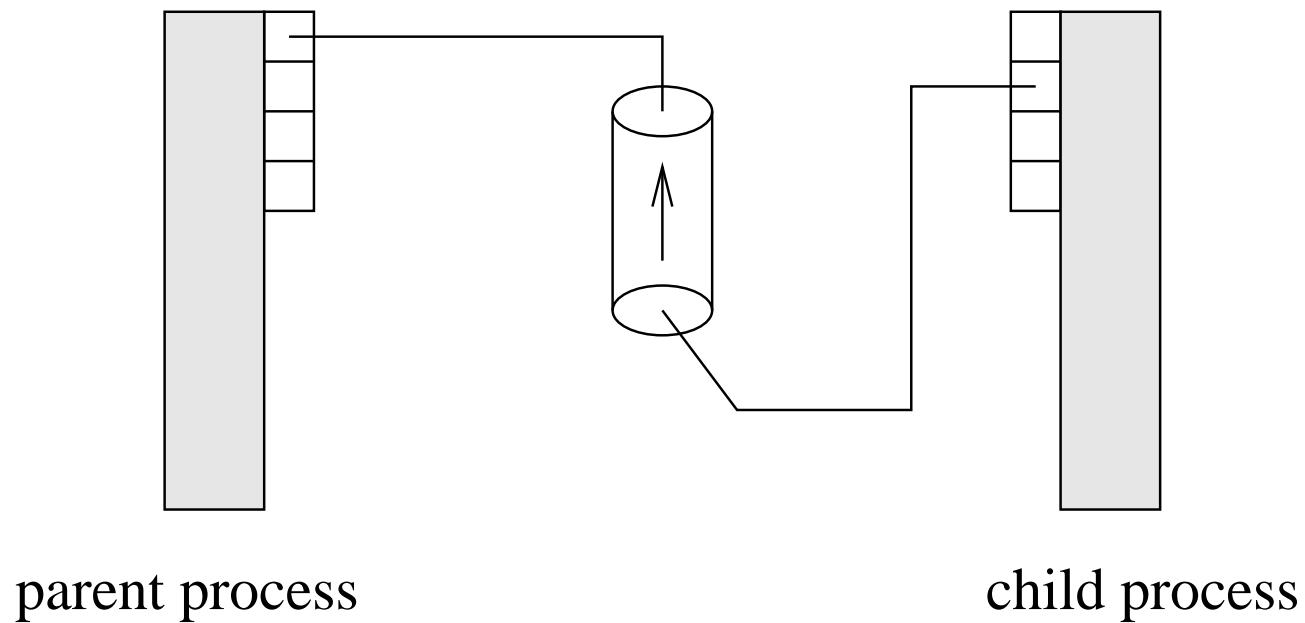

Illustration of Example (after `close()`)

Examples of Other Interprocess Communication Mechanisms

named pipe:

- similar to pipes, but with an associated name (usually a file name)
- name allows arbitrary processes to communicate by opening the same named pipe
- must be explicitly deleted, unlike an unnamed pipe

message queue:

- like a named pipe, except that there are message boundaries
- `msgsnd` call sends a message into the queue, `msgrcv` call receives the next message from the queue

Signals

- signals permit asynchronous one-way communication
 - from a process to another process, or to a group of processes, via the kernel
 - from the kernel to a process, or to a group of processes
- there are many types of signals
- the arrival of a signal may cause the execution of a *signal handler* in the receiving process
- there may be a different handler for each type of signal

Examples of Signal Types

Signal	Value	Action	Comment
SIGINT	2	Term	Interrupt from keyboard
SIGILL	4	Core	Illegal Instruction
SIGKILL	9	Term	Kill signal
SIGCHLD	20,17,18	Ign	Child stopped or terminated
SIGBUS	10,7,10	Core	Bus error
SIGXCPU	24,24,30	Core	CPU time limit exceeded
SIGSTOP	17,19,23	Stop	Stop process

Signal Handling

- operating system determines default signal handling for each new process
- example default actions:
 - ignore (do nothing)
 - kill (terminate the process)
 - stop (block the process)
- a running process can change the default for some types of signals
- signal-related system calls
 - calls to set non-default signal handlers, e.g., Unix `signal`, `sigaction`
 - calls to send signals, e.g., Unix `kill`

Implementing IPC

- application processes use descriptors (identifiers) provided by the kernel to refer to specific sockets and pipes, as well as files and other objects
- kernel *descriptor tables* (or other similar mechanism) are used to associate descriptors with kernel data structures that implement IPC objects
- kernel provides bounded buffer space for data that has been sent using an IPC mechanism, but that has not yet been received
 - for IPC objects, like pipes, buffering is usually on a per object basis
 - IPC end points, like sockets, buffering is associated with each endpoint

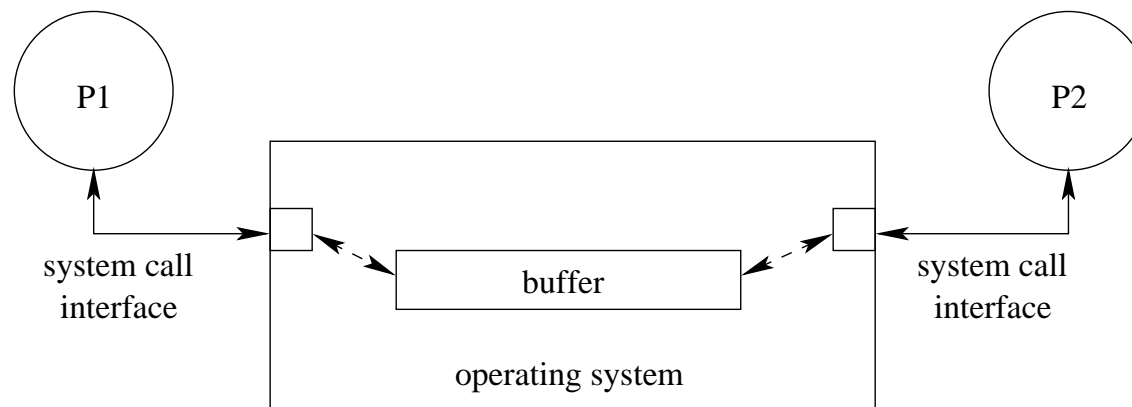

Network Interprocess Communication

- some sockets can be used to connect processes that are running on different machine
- the kernel:
 - controls access to network interfaces
 - multiplexes socket connections across the network

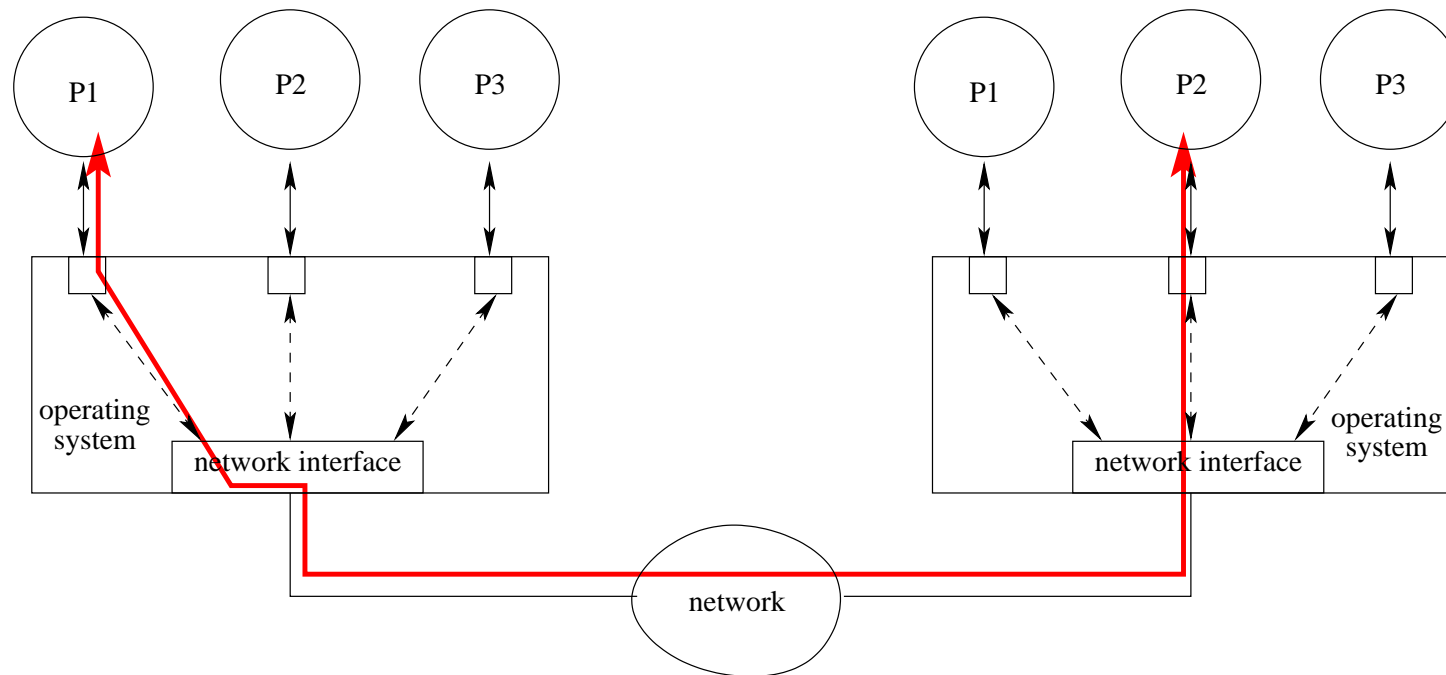

Networking Reference Models

- ISO/OSI Reference Model

7	Application Layer
6	Presentation Layer
5	Session Layer
4	Transport Layer
3	Network Layer
2	Data Link Layer
1	Physical Layer

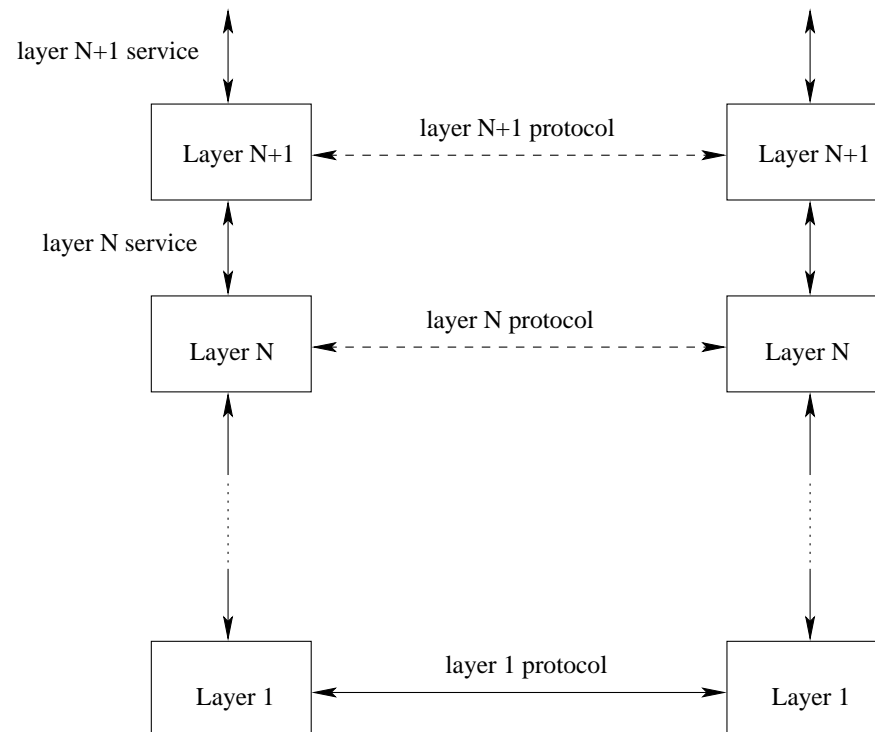

- Internet Model
 - layers 1-4 and 7

Internet Protocol (IP): Layer 3

- every machine has one (or more) IP address, in addition to its data link layer address(es)
- In IPv4, addresses are 32 bits, and are commonly written using “dot” notation, e.g.:
 - cpu06.student.cs = 129.97.152.106
 - www.google.ca = 216.239.37.99 or 216.239.51.104 or ...
- IP moves packets (datagrams) from one machine to another machine
- principal function of IP is *routing*: determining the network path that a packet should take to reach its destination
- IP packet delivery is “best effort” (unreliable)

IP Routing Table Example

- Routing table for zonker.uwaterloo.ca, which is on three networks, and has IP addresses 129.97.74.66, 172.16.162.1, and 192.168.148.1 (one per network):

Destination	Gateway	Interface
172.16.162.*	-	vmnet1
129.97.74.*	-	eth0
192.168.148.*	-	vmnet8
default	129.97.74.1	eth0

- routing table key:

destination: ultimate destination of packet

gateway: next hop towards destination (or “-” if destination is directly reachable)

interface: which network interface to use to send this packet

Internet Transport Protocols

TCP: transport control protocol

- connection-oriented
- reliable
- stream
- congestion control
- used to implement INET domain stream sockets

UDP: user datagram protocol

- connectionless
- unreliable
- datagram
- no congestion control
- used to implement INET domain datagram sockets

TCP and UDP Ports

- since there can be many TCP or UDP communications end points (sockets) on a single machine, there must be a way to distinguish among them
- each TCP or UDP address can be thought of as having two parts:
(machine name, port number)
- The machine name is the IP address of a machine, and the port number serves to distinguish among the end points on that machine.
- INET domain socket addresses are TCP or UDP addresses (depending on whether the socket is a stream socket or a datagram socket).

Example of Network Layers

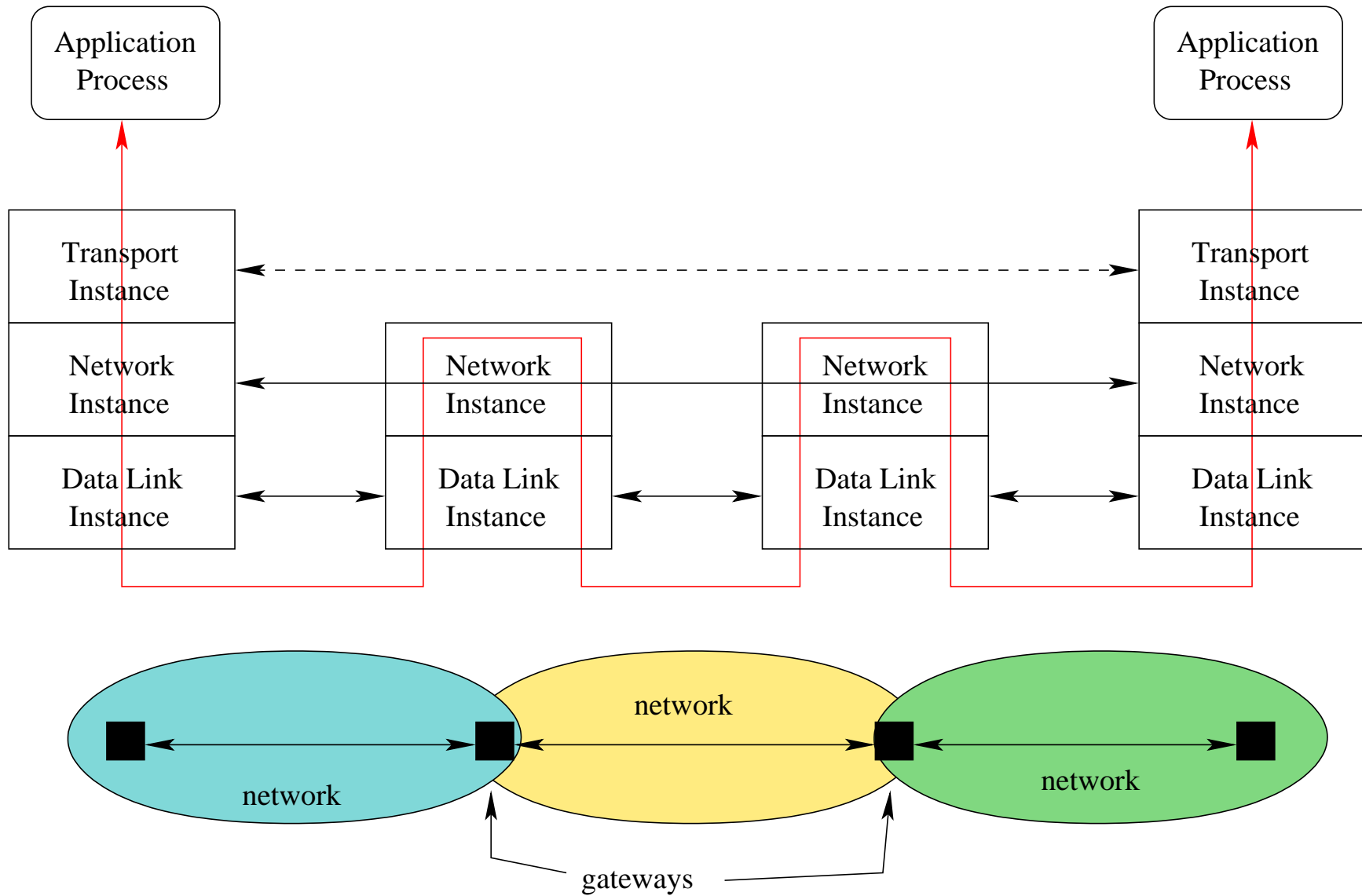

Network Packets (UDP Example)

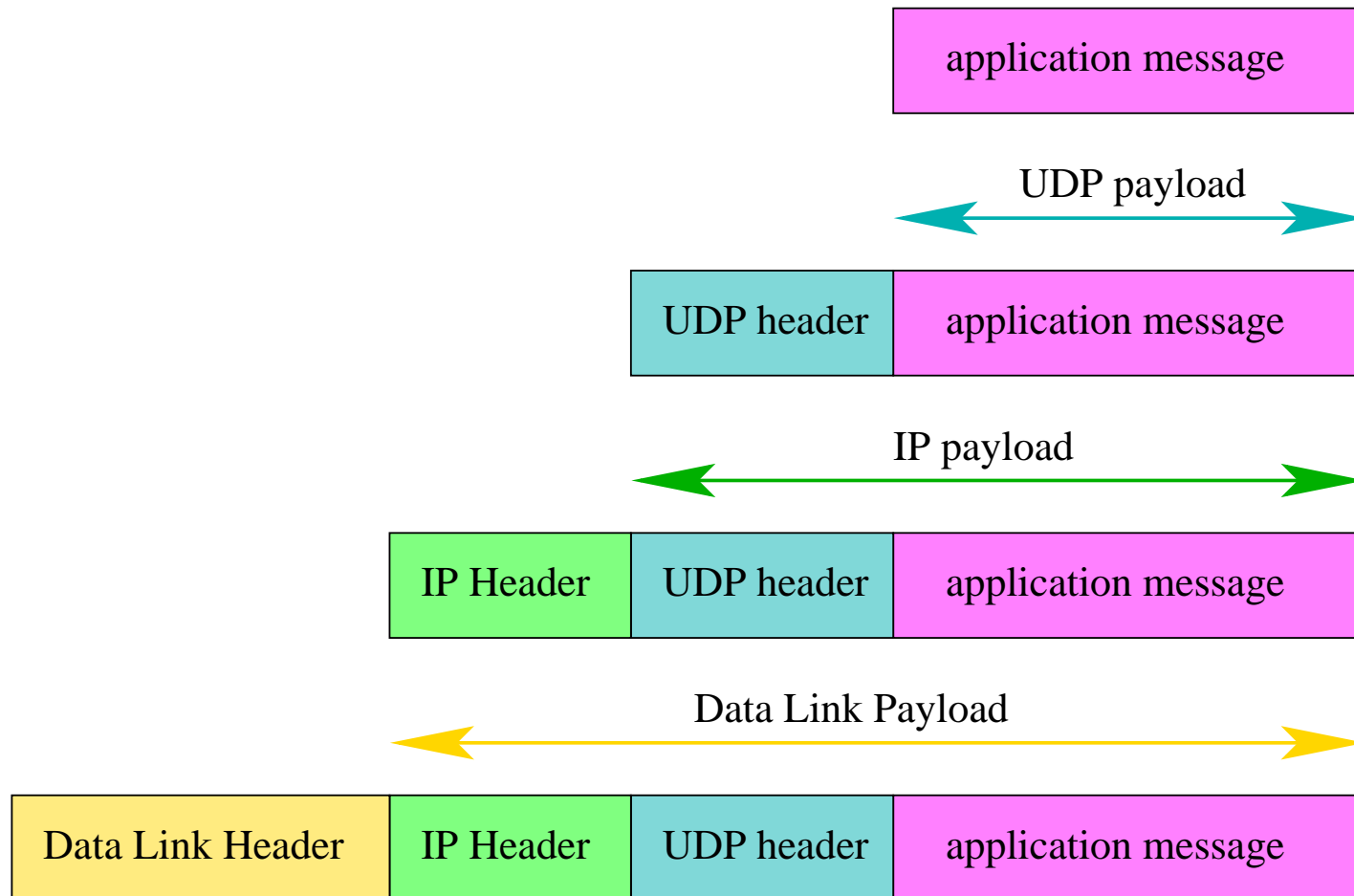

BSD Unix Networking Layers

