

CS350: Operating Systems

Ali Mashtizadeh

University of Waterloo

Administrivia

- Class web page: <https://cs.uwaterloo.ca/cs350/>
 - ▶ All assignments and handouts

- My web page: <https://rca.uwaterloo.ca/~ali/>
 - ▶ Lecture notes

- Textbooks
 - ▶ *Operating System Concepts*
 - ▶ *Operating Systems: Three Easy Pieces*

Administrivia Continued

- Q&A through Piazza (see class website)
- Midterm is scheduled for November 1, 2023
- Final will be announced later
- Four projects due throughout term
- Two reading assignments

Course Goals: Introduce you to Systems

- Operating Systems
- Distributed Systems
- Networking
- Internet of Things
- Computer Architecture
- Embedded Systems
- Database Systems
- Systems and Machine Learning
- ...

Course Goals: Practical Understanding of OSeS

- Introduce you to operating systems
 - ▶ Every computer, phone and watch runs an OS
 - ▶ Makes you a more effective programmer
 - ▶ How the OS affects your software
- General systems concepts
 - ▶ Concurrency, memory management, and I/O
 - ▶ Security and protection
 - ▶ Tools for software performance
- Practical skills
 - ▶ Learn to work with large code bases
 - ▶ My lectures: industry and research experience

What is an operating system?

- Layer between applications and hardware

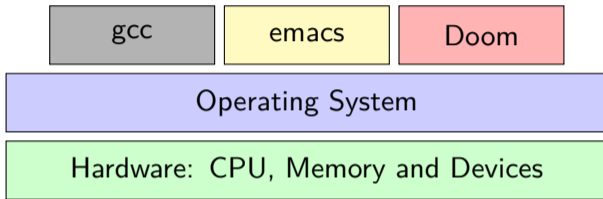

- Makes hardware useful to the programmer
- Usually: Provides abstractions for applications
 - ▶ Manages and hides details of hardware
 - ▶ Accesses hardware through low/level interfaces unavailable to applications
- Often: Provides protection
 - ▶ Prevents one process/user from clobbering another

Why study operating systems?

- Operating systems are a maturing field
 - ▶ Most people use a handful of mature OSes
 - ▶ Hard to get people to switch operating systems
 - ▶ Hard to have impact with a new OS
- High-performance servers are an OS issue
 - ▶ Face many of the same issues as OSes
- Resource consumption is an OS issue
 - ▶ Battery life, radio spectrum, etc.
- Security is an OS issue
 - ▶ Security requires a solid foundation
- New “smart” devices need new OSes
- Web browsers, databases, and game engines look like OSes

Course topics

- Threads & Processes
- Concurrency & Synchronization
- Scheduling
- Virtual Memory
- I/O
- Disks, File systems, Network file systems
- Protection & Security
- Virtual machines
- Will often use Unix as the example
 - ▶ Most OSes heavily influenced by Unix (e.g. OS161)
 - ▶ Windows is a notable exception

Primitive Operating Systems

- Just a library of standard services (no protection)

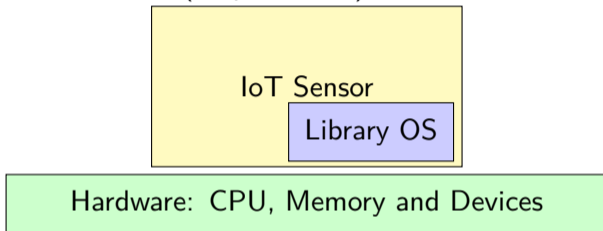

- ▶ Standard interface above hardware-specific drivers, etc.
- Simplifying assumptions
 - ▶ System runs one program at a time
 - ▶ No bad users or programs (often bad assumption)
- Problem: Poor utilization
 - ▶ ...of hardware (e.g., CPU idle while waiting for disk)
 - ▶ ...of human user (must wait for each program to finish)

Multitasking

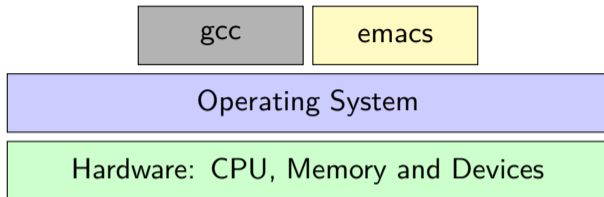

- Idea: Run more than one process at once
 - ▶ When one process blocks (waiting for user input, IO, etc.) run another process
- Problem: What can ill-behaved process do?

Multitasking

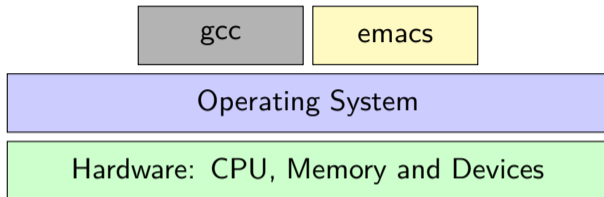

- Idea: Run more than one process at once
 - ▶ When one process blocks (waiting for user input, IO, etc.) run another process
- Problem: What can ill-behaved process do?
 - ▶ Go into infinite loop and never relinquish CPU
 - ▶ Scribble over other processes' memory to make them fail
- OS provides mechanisms to address these problems
 - ▶ *Preemption* – take CPU away from looping process
 - ▶ *Memory protection* – protect process's memory from one another

Multi-user OSES

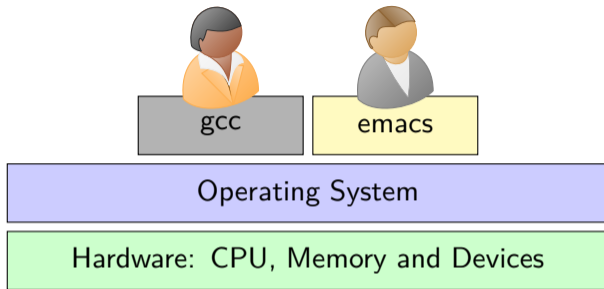

- Many OSES use *protection* to serve distrustful users/apps
- Idea: With N users, system not N times slower
 - ▶ User demand for CPU is bursty
- What can go wrong?

Multi-user OSes

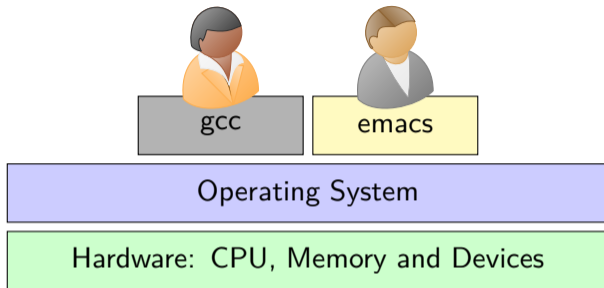

- Many OSes use *protection* to serve distrustful users/apps
- Idea: With N users, system not N times slower
 - ▶ User demand for CPU is bursty
- What can go wrong?
 - ▶ Users are gluttons, use too much CPU, etc. (need policies)
 - ▶ Total memory usage greater than in machine (must virtualize)
 - ▶ Super-linear slowdown with increasing demand (thrashing)

Protection

- Mechanisms that isolate bad programs and people
- Pre-emption:
 - ▶ Give application a resource, take it away if needed elsewhere
- Interposition/mediation:
 - ▶ Place OS between application and “stuff”
 - ▶ Track all pieces that application allowed to use (e.g., in table)
 - ▶ On every access, look in table to check that access legal
- Privileged & unprivileged modes in CPUs:
 - ▶ Applications unprivileged (unprivileged *user* mode)
 - ▶ OS privileged (privileged supervisor/*kernel* mode)
 - ▶ Protection operations can only be done in privileged mode

Typical OS structure

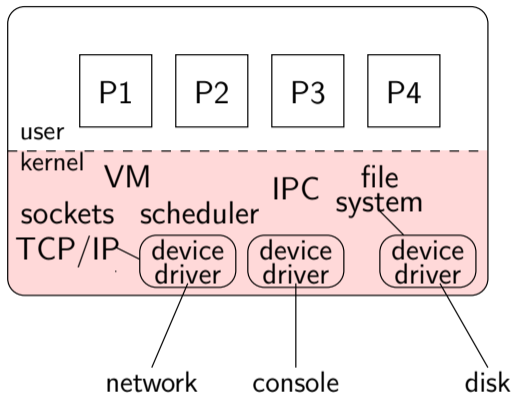

- Most software runs as user-level processes (P[1-4])
- OS *kernel* runs in *privileged* mode (shaded)
 - ▶ Creates/deletes processes
 - ▶ Provides access to hardware

System calls

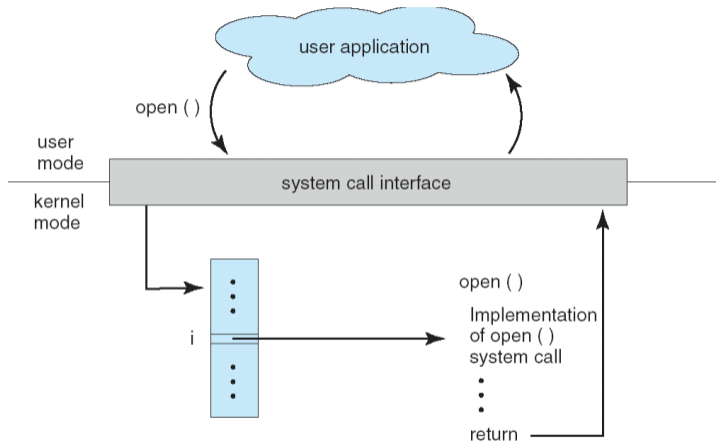

- Applications can invoke kernel through *system calls*
 - ▶ Special instruction transfers control to kernel
 - ▶ ... which dispatches to one of few hundred syscall handlers

System calls (continued)

- Goal: Do things app. can't do in unprivileged mode
 - ▶ Like a library call, but into more privileged kernel code
- Kernel supplies well-defined *system call* interface
 - ▶ Applications set up syscall arguments and *trap* to kernel
 - ▶ Kernel performs operation and returns result
- Higher-level functions built on syscall interface
 - ▶ `printf`, `scanf`, `gets`, etc. all user-level code
- Example: POSIX/UNIX interface
 - ▶ `open`, `close`, `read`, `write`, ...

System call example

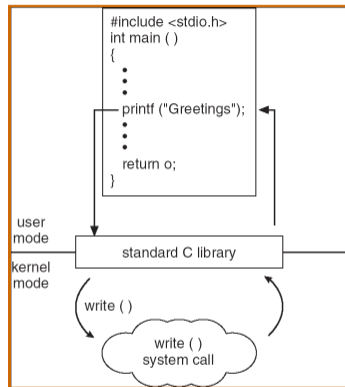

- Standard library implemented in terms of syscalls
 - ▶ `printf` – in `libc`, has same privileges as application
 - ▶ calls `write` – in kernel, which can send bits out serial port