



AMD64 Technology

AMD64 Architecture

Programmer's Manual

Volume 1:

Application Programming

Publication No.	Revision	Date
24592	3.10	March 2005

© 2002, 2003, 2004, 2005 Advanced Micro Devices, Inc. All rights reserved.

The contents of this document are provided in connection with Advanced Micro Devices, Inc. ("AMD") products. AMD makes no representations or warranties with respect to the accuracy or completeness of the contents of this publication and reserves the right to make changes to specifications and product descriptions at any time without notice. No license, whether express, implied, arising by estoppel or otherwise, to any intellectual property rights is granted by this publication. Except as set forth in AMD's Standard Terms and Conditions of Sale, AMD assumes no liability whatsoever, and disclaims any express or implied warranty, relating to its products including, but not limited to, the implied warranty of merchantability, fitness for a particular purpose, or infringement of any intellectual property right.

AMD's products are not designed, intended, authorized or warranted for use as components in systems intended for surgical implant into the body, or in other applications intended to support or sustain life, or in any other application in which the failure of AMD's product could create a situation where personal injury, death, or severe property or environmental damage may occur. AMD reserves the right to discontinue or make changes to its products at any time without notice.

Trademarks

AMD, the AMD arrow logo, AMD Athlon, and AMD Opteron, and combinations thereof, and 3DNow! are trademarks, and AMD-K6 is a registered trademark of Advanced Micro Devices, Inc.

MMX is a trademark and Pentium is a registered trademark of Intel Corporation.

Windows NT is a registered trademark of Microsoft Corporation.

Other product names used in this publication are for identification purposes only and may be trademarks of their respective companies.

Contents

Figuresxi
Tables	xv
Revision History	xvii
Preface	xix
About This Book	xix
Audience	xix
Contact Information	xix
Organization	xx
Definitions	xx
Related Documents	xxxi
1 Overview of the AMD64 Architecture	1
1.1 Introduction	1
New Features	1
Registers	3
Instruction Set	4
Media Instructions	5
Floating-Point Instructions	6
1.2 Modes of Operation	7
Long Mode	7
64-Bit Mode	8
Compatibility Mode	9
Legacy Mode	9
2 Memory Model	11
2.1 Memory Organization	11
Virtual Memory	11
Segment Registers	12
Physical Memory	13
Memory Management	14
2.2 Memory Addressing	16
Byte Ordering	16
64-bit Canonical Addresses	18
Effective Addresses	18
Address-Size Prefix	21
RIP-Relative Addressing	22
2.3 Pointers	22
Near and Far Pointers	23
2.4 Stack Operation	23
2.5 Instruction Pointer	24
3 General-Purpose Programming	27

3.1	Registers	27
	Legacy Registers	28
	64-Bit-Mode Registers	30
	Implicit Uses of GPRs	34
	Flags Register	37
	Instruction Pointer Register	41
3.2	Operands	41
	Data Types	41
	Operand Sizes and Overrides	44
	Operand Addressing	46
	Data Alignment	47
3.3	Instruction Summary	48
	Syntax	48
	Data Transfer	49
	Data Conversion	54
	Load Segment Registers	58
	Load Effective Address	58
	Arithmetic	59
	Rotate and Shift	61
	Compare and Test	64
	Logical	67
	String	68
	Control Transfer	69
	Flags	75
	Input/Output	76
	Semaphores	78
	Processor Information	79
	Cache and Memory Management	79
	No Operation	80
	System Calls	81
3.4	General Rules for Instructions in 64-Bit Mode	81
	Address Size	81
	Canonical Address Format	82
	Branch-Displacement Size	82
	Operand Size	82
	High 32 Bits	84
	Invalid and Reassigned Instructions	84
	Instructions with 64-Bit Default Operand Size	85
3.5	Instruction Prefixes	86
	Legacy Prefixes	86
	REX Prefixes	90
3.6	Feature Detection	91
3.7	Control Transfers	93
	Overview	93
	Privilege Levels	94
	Procedure Stack	95
	Jumps	96

	Procedure Calls	97
	Returning from Procedures	100
	System Calls	103
	General Considerations for Branching	103
	Branching in 64-Bit Mode	104
	Interrupts and Exceptions	105
3.8	Input/Output	110
	I/O Addressing	111
	I/O Ordering	112
	Protected-Mode I/O	113
3.9	Memory Optimization	114
	Accessing Memory	114
	Forcing Memory Order	116
	Caches	118
	Cache Operation	120
	Cache Pollution	122
	Cache-Control Instructions	123
3.10	Performance Considerations	125
	Use Large Operand Sizes	126
	Use Short Instructions	126
	Align Data	126
	Avoid Branches	126
	Prefetch Data	126
	Keep Common Operands in Registers	127
	Avoid True Dependencies	127
	Avoid Store-to-Load Dependencies	127
	Optimize Stack Allocation	127
	Consider Repeat-Prefix Setup Time	127
	Replace GPR with Media Instructions	127
	Organize Data in Memory Blocks	128
4	128-Bit Media and Scientific Programming	129
4.1	Overview	129
	Origins	129
	Compatibility	129
4.2	Capabilities	130
	Types of Applications	130
	Integer Vector Operations	131
	Floating-Point Vector Operations	132
	Data Conversion and Reordering	133
	Block Operations	135
	Matrix and Special Arithmetic Operations	137
	Branch Removal	139
4.3	Registers	141
	XMM Registers	141
	MXCSR Register	142
	Other Data Registers	146
	rFLAGS Registers	147

4.4	Operands	147
	Data Types	147
	Operand Sizes and Overrides	149
	Operand Addressing	149
	Data Alignment	150
	Integer Data Types	150
	Floating-Point Data Types	152
	Floating-Point Number Representation	155
	Floating-Point Number Encodings	158
	Floating-Point Rounding	160
4.5	Instruction Summary—Integer Instructions	162
	Syntax	162
	Data Transfer	164
	Data Conversion	169
	Data Reordering	171
	Arithmetic	177
	Shift	184
	Compare	186
	Logical	188
	Save and Restore State	189
4.6	Instruction Summary—Floating-Point Instructions	190
	Syntax	190
	Data Transfer	190
	Data Conversion	195
	Data Reordering	199
	Arithmetic	201
	Compare	208
	Logical	212
4.7	Instruction Effects on Flags	213
4.8	Instruction Prefixes	214
	Supported Prefixes	214
	Special-Use and Reserved Prefixes	214
	Prefixes That Cause Exceptions	214
4.9	Feature Detection	215
4.10	Exceptions	215
	General-Purpose Exceptions	216
	SIMD Floating-Point Exception Causes	217
	SIMD Floating-Point Exception Priority	222
	SIMD Floating-Point Exception Masking	224
4.11	Saving, Clearing, and Passing State	228
	Saving and Restoring State	228
	Parameter Passing	228
	Accessing Operands in MMX™ Registers	229
4.12	Performance Considerations	230
	Use Small Operand Sizes	230
	Reorganize Data for Parallel Operations	230
	Remove Branches	230

	Use Streaming Stores	231
	Align Data	231
	Organize Data for Cacheability	231
	Prefetch Data	231
	Use 128-Bit Media Code for Moving Data	232
	Retain Intermediate Results in XMM Registers	232
	Replace GPR Code with 128-bit media Code	232
	Replace x87 Code with 128-Bit Media Code	232
5	64-Bit Media Programming	235
5.1	Origins	235
5.2	Compatibility	236
5.3	Capabilities	236
	Parallel Operations	237
	Data Conversion and Reordering	237
	Matrix Operations	239
	Saturation	240
	Branch Removal	240
	Floating-Point (3DNow!™) Vector Operations	242
5.4	Registers	243
	MMX™ Registers	243
	Other Registers	244
5.5	Operands	244
	Data Types	244
	Operand Sizes and Overrides	246
	Operand Addressing	246
	Data Alignment	247
	Integer Data Types	247
	Floating-Point Data Types	249
5.6	Instruction Summary—Integer Instructions	251
	Syntax	252
	Exit Media State	253
	Data Transfer	254
	Data Conversion	256
	Data Reordering	257
	Arithmetic	261
	Shift	266
	Compare	268
	Logical	269
	Save and Restore State	270
5.7	Instruction Summary—Floating-Point Instructions	271
	Syntax	272
	Data Conversion	272
	Arithmetic	273
	Compare	277
5.8	Instruction Effects on Flags	278
5.9	Instruction Prefixes	278
	Supported Prefixes	278

	Special-Use and Reserved Prefixes	279
	Prefixes That Cause Exceptions	279
5.10	Feature Detection	279
5.11	Exceptions	280
	General-Purpose Exceptions	280
	x87 Floating-Point Exceptions (#MF)	282
5.12	Actions Taken on Executing 64-Bit Media Instructions	282
5.13	Mixing Media Code with x87 Code	284
	Mixing Code	284
	Clearing MMX™ State	285
5.14	State-Saving	285
	Saving and Restoring State	285
	State-Saving Instructions	286
5.15	Performance Considerations	287
	Use Small Operand Sizes	287
	Reorganize Data for Parallel Operations	287
	Remove Branches	287
	Align Data	288
	Organize Data for Cacheability	288
	Prefetch Data	288
	Retain Intermediate Results in MMX™ Registers	289
6	x87 Floating-Point Programming	291
6.1	Overview	291
	Origins	291
	Compatibility	291
6.2	Capabilities	292
6.3	Registers	293
	x87 Data Registers	294
	x87 Status Word Register (FSW)	295
	x87 Control Word Register (FCW)	299
	x87 Tag Word Register (FTW)	301
	Pointers and Opcode State	303
	x87 Environment	304
	Floating-Point Emulation (CR0.EM)	305
6.4	Operands	306
	Operand Addressing	306
	Data Types	306
	Number Representation	310
	Number Encodings	314
	Precision	319
	Rounding	320
6.5	Instruction Summary	321
	Syntax	321
	Data Transfer and Conversion	323
	Load Constants	327
	Arithmetic	327
	Transcendental Functions	332

	Compare and Test	334
	Stack Management	337
	No Operation	338
	Control	338
6.6	Instruction Effects on rFLAGS	342
6.7	Instruction Prefixes.....	342
6.8	Feature Detection	343
6.9	Exceptions	344
	General-Purpose Exceptions	344
	x87 Floating-Point Exception Causes	345
	x87 Floating-Point Exception Priority.....	349
	x87 Floating-Point Exception Masking	351
6.10	State-Saving	358
	State-Saving Instructions	358
6.11	Performance Considerations	359
	Replace x87 Code with 128-Bit Media Code.....	359
	Use FCOMI-FCMOV _x Branching	359
	Use FSINCOS Instead of FSIN and FCOS	360
	Break Up Dependency Chains	360
	Index.....	361

Figures

Figure 1-1. Application-Programming Register Set	2
Figure 2-1. Virtual-Memory Segmentation	12
Figure 2-2. Segment Registers	13
Figure 2-3. Long-Mode Memory Management	14
Figure 2-4. Legacy-Mode Memory Management	15
Figure 2-5. Byte Ordering	17
Figure 2-6. Example of 10-Byte Instruction in Memory	18
Figure 2-7. Complex Address Calculation (Protected Mode)	19
Figure 2-8. Near and Far Pointers	23
Figure 2-9. Stack Pointer Mechanism	24
Figure 2-10. Instruction Pointer (rIP) Register	25
Figure 3-1. General-Purpose Programming Registers	28
Figure 3-2. General Registers in Legacy and Compatibility Modes	29
Figure 3-3. General Registers in 64-Bit Mode	31
Figure 3-4. GPRs in 64-Bit Mode	32
Figure 3-5. rFLAGS Register—Flags Visible to Application Software	38
Figure 3-6. General-Purpose Data Types	42
Figure 3-7. Mnemonic Syntax Example	48
Figure 3-8. BSWAP Doubleword Exchange	57
Figure 3-9. Privilege-Level Relationships	94
Figure 3-10. Procedure Stack, Near Call	98
Figure 3-11. Procedure Stack, Far Call to Same Privilege	99
Figure 3-12. Procedure Stack, Far Call to Greater Privilege	100
Figure 3-13. Procedure Stack, Near Return	101
Figure 3-14. Procedure Stack, Far Return from Same Privilege	102
Figure 3-15. Procedure Stack, Far Return from Less Privilege	102
Figure 3-16. Procedure Stack, Interrupt to Same Privilege	109
Figure 3-17. Procedure Stack, Interrupt to Higher Privilege	110
Figure 3-18. I/O Address Space	112
Figure 3-19. Memory Hierarchy Example	120
Figure 4-1. Parallel Operations on Vectors of Integer Elements	131

Figure 4-2. Parallel Operations on Vectors of Floating-Point Elements .	132
Figure 4-3. Unpack and Interleave Operation	133
Figure 4-4. Pack Operation	134
Figure 4-5. Shuffle Operation	134
Figure 4-6. Move Operations	136
Figure 4-7. Move Mask Operation	137
Figure 4-8. Multiply-Add Operation	138
Figure 4-9. Sum-of-Absolute-Differences Operation	139
Figure 4-10. Branch-Removal Sequence	140
Figure 4-11. Move Mask Operation	141
Figure 4-12. 128-bit Media Registers	142
Figure 4-13. 128-Bit Media Control and Status Register (MXCSR)	143
Figure 4-14. 128-Bit Media Data Types	148
Figure 4-15. 128-Bit Media Floating-Point Data Types	153
Figure 4-16. Mnemonic Syntax for Typical Instruction	162
Figure 4-17. Integer Move Operations	167
Figure 4-18. MASKMOVDQU Move Mask Operation	168
Figure 4-19. PMOVMASKB Move Mask Operation	169
Figure 4-20. PACKSSDW Pack Operation	172
Figure 4-21. PUNPCKLWD Unpack and Interleave Operation	173
Figure 4-22. PINSRW Operation	175
Figure 4-23. PSHUFD Shuffle Operation	176
Figure 4-24. PSHUFW Shuffle Operation	176
Figure 4-25. Arithmetic Operation on Vectors of Bytes	177
Figure 4-26. PMULxW Multiply Operation	180
Figure 4-27. PMULUDQ Multiply Operation	181
Figure 4-28. PMADDWD Multiply-Add Operation	182
Figure 4-29. PSADBW Sum-of-Absolute-Differences Operation	184
Figure 4-30. PCMPEQB Compare Operation	187
Figure 4-31. Floating-Point Move Operations	192
Figure 4-32. MOVMSKPS Move Mask Operation	195
Figure 4-33. UNPCKLPS Unpack and Interleave Operation	200
Figure 4-34. SHUFPS Shuffle Operation	201

Figure 4-35.ADDPS Arithmetic Operation	202
Figure 4-36.CMPPD Compare Operation	210
Figure 4-37.COMISD Compare Operation	212
Figure 4-38.SIMD Floating-Point Detection Process.	223
Figure 5-1. Parallel Integer Operations on Elements of Vectors	237
Figure 5-2. Unpack and Interleave Operation	238
Figure 5-3. Shuffle Operation (1 of 256)	239
Figure 5-4. Multiply-Add Operation	240
Figure 5-5. Branch-Removal Sequence	241
Figure 5-6. Floating-Point (3DNow!™ Instruction) Operations	242
Figure 5-7. 64-bit Media Registers.	243
Figure 5-8. 64-Bit Media Data Types	245
Figure 5-9. 64-Bit Floating-Point (3DNow!) Vector Operand	249
Figure 5-10.Mnemonic Syntax for Typical Instruction	252
Figure 5-11.MASKMOVQ Move Mask Operation	255
Figure 5-12.PACKSSDW Pack Operation.	258
Figure 5-13.PUNPCKLWD Unpack and Interleave Operation	259
Figure 5-14.PSHUFW Shuffle Operation	260
Figure 5-15.PSWAPD Swap Operation.	261
Figure 5-16.PMADDWD Multiply-Add Operation.	265
Figure 5-17.PFACC Accumulate Operation.	275
Figure 6-1. x87 Registers.	293
Figure 6-2. x87 Physical and Stack Registers	294
Figure 6-3. x87 Status Word Register (FSW)	296
Figure 6-4. x87 Control Word Register (FCW)	299
Figure 6-5. x87 Tag Word Register (FTW)	302
Figure 6-6. x87 Pointers and Opcode State.	303
Figure 6-7. x87 Data Types	307
Figure 6-8. x87 Floating-Point Data Types	308
Figure 6-9. x87 Packed Decimal Data Type	310
Figure 6-10.Mnemonic Syntax for Typical Instruction	322

Tables

Table 1-1.	Operating Modes	3
Table 1-2.	Application Registers and Stack, by Operating Mode	4
Table 2-1.	Address-Size Prefixes.	21
Table 3-1.	Implicit Uses of GPRs	35
Table 3-2.	Representable Values of General-Purpose Data Types	44
Table 3-3.	Operand-Size Overrides.	46
Table 3-4.	rFLAGS for CMOVcc Instructions	52
Table 3-5.	rFLAGS for SETcc Instructions.	67
Table 3-6.	rFLAGS for Jcc Instructions	72
Table 3-7.	Legacy Instruction Prefixes	88
Table 3-8.	Instructions that Implicitly Reference RSP in 64-Bit Mode	98
Table 3-9.	Near Branches in 64-Bit Mode.	105
Table 3-10.	Interrupts and Exceptions.	108
Table 4-1.	MXCSR Register Reset Values.	146
Table 4-2.	Range of Values in 128-Bit Media Integer Data Types	153
Table 4-3.	Saturation Examples	154
Table 4-4.	Range of Values in Normalized Floating-Point Data Types	156
Table 4-5.	Example of Denormalization.	158
Table 4-6.	NaN Results	160
Table 4-7.	Supported Floating-Point Encodings	161
Table 4-8.	Indefinite-Value Encodings.	162
Table 4-9.	Types of Rounding	163
Table 4-10.	Example PANDN Bit Values.	191
Table 4-11.	SIMD Floating-Point Exception Flags	220
Table 4-12.	Invalid-Operation Exception (IE) Causes	222
Table 4-13.	Priority of SIMD Floating-Point Exceptions	224
Table 4-14.	SIMD Floating-Point Exception Masks	226
Table 4-15.	Masked Responses to SIMD Floating-Point Exceptions.	227
Table 5-1.	Range of Values in 64-Bit Media Integer Data Types	250
Table 5-2.	Saturation Examples	250
Table 5-3.	Range of Values in 64-Bit Media Floating-Point Data Types	252
Table 5-4.	64-Bit Floating-Point Exponent Ranges.	252
Table 5-5.	Example PANDN Bit Values.	272
Table 5-6.	Mapping Between Internal and Software-Visible Tag Bits	286

Table 6-1.	Precision Control (PC) Summary	302
Table 6-2.	Types of Rounding	303
Table 6-3.	Mapping Between Internal and Software-Visible Tag Bits . .	304
Table 6-4.	Instructions that Access the x87 Environment	307
Table 6-5.	Range of Finite Floating-Point Values.	311
Table 6-6.	Example of Denormalization.	315
Table 6-7.	NaN Results from NaN Source Operands	317
Table 6-8.	Supported Floating-Point Encodings	318
Table 6-9.	Unsupported Floating-Point Encodings.	320
Table 6-10.	Indefinite-Value Encodings.	321
Table 6-11.	Precision Control Field (PC) Values and Bit Precision	321
Table 6-12.	Types of Rounding	322
Table 6-13.	rFLAGS Conditions for FCMOV _{cc}	327
Table 6-14.	rFLAGS Values for FCOMI Instruction	337
Table 6-15.	Condition-Code Settings for FXAM	339
Table 6-16.	Instruction Effects on rFLAGS	344
Table 6-17.	x87 Floating-Point (#MF) Exception Flags	348
Table 6-18.	Invalid-Operation Exception (IE) Causes	349
Table 6-19.	Priority of x87 Floating-Point Exceptions	352
Table 6-20.	x87 Floating-Point (#MF) Exception Masks	353
Table 6-21.	Masked Responses to x87 Floating-Point Exceptions	354
Table 6-22.	Unmasked Responses to x87 Floating-Point Exceptions	357

Revision History

Date	Revision	Description
February 2005	3.10	Clarified “Self-Modifying Code” on page 123. Made several patches to index references. Added general descriptions of SSE3 instructions to Chapter 4. Added description of the CMPXCHG16B instruction to Chapter 3. Corrected minor typographical errors. Elaborated explanation of PREFETCH/level instructions.
September 2003	3.09	Corrected several factual errors.
September, 2002	3.07	Corrected minor organizational problems in sections dealing with ‘Prefetch’ instructions in chapters 3, 4, and 5. Clarified the general description of the operation of certain 128-bit media instructions in chapter 1. Corrected a factual error in the description of the FNINIT/FINIT instructions in chapter 6. Corrected operand descriptions for the CMOVcc instructions in chapter 3. Added Revision History. Corrected marketing denotations.

Preface

About This Book

This book is part of a multivolume work entitled the *AMD64 Architecture Programmer's Manual*. This table lists each volume and its order number.

Title	Order No.
Volume 1, <i>Application Programming</i>	24592
Volume 2, <i>System Programming</i>	24593
Volume 3, <i>General-Purpose and System Instructions</i>	24594
Volume 4, <i>128-Bit Media Instructions</i>	26568
Volume 5, <i>64-Bit Media and x87 Floating-Point Instructions</i>	26569

Audience

This volume (Volume 1) is intended for programmers writing application programs, compilers, or assemblers. It assumes prior experience in microprocessor programming, although it does not assume prior experience with the legacy x86 or AMD64 microprocessor architecture.

This volume describes the AMD64 architecture's resources and functions that are accessible to application software, including memory, registers, instructions, operands, I/O facilities, and application-software aspects of control transfers (including interrupts and exceptions) and performance optimization.

System-programming topics—including the use of instructions running at a current privilege level (CPL) of 0 (most-privileged)—are described in Volume 2. Details about each instruction are described in volumes 3, 4, and 5.

Contact Information

To submit questions or comments concerning this document, contact our technical documentation staff at AMD64.Feedback@amd.com.

Organization

This volume begins with an overview of the architecture and its memory organization and is followed by chapters that describe the four application-programming models available in the AMD64 architecture:

- *General-Purpose Programming*—This model uses the integer general-purpose registers (GPRs). The chapter describing it also describes the basic application environment for exceptions, control transfers, I/O, and memory optimization that applies to all other application-programming models.
- *128-bit Media Programming*—This model uses the 128-bit XMM registers and supports integer and floating-point operations on vector (packed) and scalar data types.
- *64-bit Media Programming*—This model uses the 64-bit MMX™ registers and supports integer and floating-point operations on vector (packed) and scalar data types.
- *x87 Floating-Point Programming*—This model uses the 80-bit x87 registers and supports floating-point operations on scalar data types.

Definitions assumed throughout this volume are listed below. The index at the end of this volume cross-references topics within the volume. For other topics relating to the AMD64 architecture, see the tables of contents and indexes of the other volumes.

Definitions

Some of the following definitions assume a knowledge of the legacy x86 architecture. See “Related Documents” on page xxxi for further information about the legacy x86 architecture.

Terms and Notation

1011b

A binary value—in this example, a 4-bit value.

F0EAh

A hexadecimal value—in this example a 2-byte value.

[1,2)

A range that includes the left-most value (in this case, 1) but excludes the right-most value (in this case, 2).

7–4

A bit range, from bit 7 to 4, inclusive. The high-order bit is shown first.

128-bit media instructions

Instructions that use the 128-bit XMM registers. These are a combination of the SSE and SSE2 instruction sets.

64-bit media instructions

Instructions that use the 64-bit MMX registers. These are primarily a combination of MMX and 3DNow!™ instruction sets, with some additional instructions from the SSE and SSE2 instruction sets.

16-bit mode

Legacy mode or compatibility mode in which a 16-bit address size is active. See *legacy mode* and *compatibility mode*.

32-bit mode

Legacy mode or compatibility mode in which a 32-bit address size is active. See *legacy mode* and *compatibility mode*.

64-bit mode

A submode of *long mode*. In 64-bit mode, the default address size is 64 bits and new features, such as register extensions, are supported for system and application software.

#GP(0)

Notation indicating a general-protection exception (#GP) with error code of 0.

absolute

Said of a displacement that references the base of a code segment rather than an instruction pointer. Contrast with *relative*.

biased exponent

The sum of a floating-point value's exponent and a constant bias for a particular floating-point data type. The bias makes the range of the biased exponent always positive, which allows reciprocation without overflow.

byte

Eight bits.

clear

To write a bit value of 0. Compare *set*.

compatibility mode

A submode of *long mode*. In compatibility mode, the default address size is 32 bits, and legacy 16-bit and 32-bit applications run without modification.

commit

To irreversibly write, in program order, an instruction's result to software-visible storage, such as a register (including flags), the data cache, an internal write buffer, or memory.

CPL

Current privilege level.

CR0–CR4

A register range, from register CR0 through CR4, inclusive, with the low-order register first.

CR0.PE = 1

Notation indicating that the PE bit of the CR0 register has a value of 1.

direct

Referencing a memory location whose address is included in the instruction's syntax as an immediate operand. The address may be an absolute or relative address. Compare *indirect*.

dirty data

Data held in the processor's caches or internal buffers that is more recent than the copy held in main memory.

displacement

A signed value that is added to the base of a segment (absolute addressing) or an instruction pointer (relative addressing). Same as *offset*.

doubleword

Two words, or four bytes, or 32 bits.

double quadword

Eight words, or 16 bytes, or 128 bits. Also called *octword*.

DS:rSI

The contents of a memory location whose segment address is in the DS register and whose offset relative to that segment is in the rSI register.

EFER.LME = 0

Notation indicating that the LME bit of the EFER register has a value of 0.

effective address size

The address size for the current instruction after accounting for the default address size and any address-size override prefix.

effective operand size

The operand size for the current instruction after accounting for the default operand size and any operand-size override prefix.

element

See *vector*.

exception

An abnormal condition that occurs as the result of executing an instruction. The processor's response to an exception depends on the type of the exception. For all exceptions except 128-bit media SIMD floating-point exceptions and x87 floating-point exceptions, control is transferred to the handler (or service routine) for that exception, as defined by the exception's vector. For floating-point exceptions defined by the IEEE 754 standard, there are both masked and unmasked responses. When unmasked, the exception handler is called, and when masked, a default response is provided instead of calling the handler.

FF /0

Notation indicating that FF is the first byte of an opcode, and a subopcode in the ModR/M byte has a value of 0.

flush

An often ambiguous term meaning (1) writeback, if modified, and invalidate, as in “flush the cache line,” or (2)

invalidate, as in “flush the pipeline,” or (3) change a value, as in “flush to zero.”

GDT

Global descriptor table.

IDT

Interrupt descriptor table.

IGN

Ignore. Field is ignored.

indirect

Referencing a memory location whose address is in a register or other memory location. The address may be an absolute or relative address. Compare *direct*.

IRB

The virtual-8086 mode interrupt-redirection bitmap.

IST

The long-mode interrupt-stack table.

IVT

The real-address mode interrupt-vector table.

LDT

Local descriptor table.

legacy x86

The legacy x86 architecture. See “Related Documents” on page xxxi for descriptions of the legacy x86 architecture.

legacy mode

An operating mode of the AMD64 architecture in which existing 16-bit and 32-bit applications and operating systems run without modification. A processor implementation of the AMD64 architecture can run in either *long mode* or *legacy mode*. Legacy mode has three submodes, *real mode*, *protected mode*, and *virtual-8086 mode*.

long mode

An operating mode unique to the AMD64 architecture. A processor implementation of the AMD64 architecture can run in either *long mode* or *legacy mode*. Long mode has two submodes, *64-bit mode* and *compatibility mode*.

lsb

Least-significant bit.

LSB

Least-significant byte.

main memory

Physical memory, such as RAM and ROM (but not cache memory) that is installed in a particular computer system.

mask

(1) A control bit that prevents the occurrence of a floating-point exception from invoking an exception-handling routine. (2) A field of bits used for a control purpose.

MBZ

Must be zero. If software attempts to set an MBZ bit to 1, a general-protection exception (#GP) occurs.

memory

Unless otherwise specified, *main memory*.

ModRM

A byte following an instruction opcode that specifies address calculation based on mode (Mod), register (R), and memory (M) variables.

moffset

A 16, 32, or 64-bit offset that specifies a memory operand directly, without using a ModRM or SIB byte.

msb

Most-significant bit.

MSB

Most-significant byte.

multimedia instructions

A combination of *128-bit media instructions* and *64-bit media instructions*.

octword

Same as *double quadword*.

offset

Same as *displacement*.

overflow

The condition in which a floating-point number is larger in magnitude than the largest, finite, positive or negative number that can be represented in the data-type format being used.

packed

See *vector*.

PAE

Physical-address extensions.

physical memory

Actual memory, consisting of *main memory* and cache.

probe

A check for an address in a processor's caches or internal buffers. *External probes* originate outside the processor, and *internal probes* originate within the processor.

protected mode

A submode of *legacy mode*.

quadword

Four words, or eight bytes, or 64 bits.

RAZ

Read as zero (0), regardless of what is written.

real-address mode

See *real mode*.

real mode

A short name for *real-address mode*, a submode of *legacy mode*.

relative

Referencing with a displacement (also called offset) from an instruction pointer rather than the base of a code segment. Contrast with *absolute*.

reserved

Fields marked as reserved may be used at some future time.

To preserve compatibility with future processors, reserved fields require special handling when read or written by software.

Reserved fields may be further qualified as MBZ, RAZ, SBZ or IGN (see definitions).

Software must not depend on the state of a reserved field, nor upon the ability of such fields to return to a previously written state.

If a reserved field is not marked with one of the above qualifiers, software must not change the state of that field; it must reload that field with the same values returned from a prior read.

REX

An instruction prefix that specifies a 64-bit operand size and provides access to additional registers.

RIP-relative addressing

Addressing relative to the 64-bit RIP instruction pointer.

set

To write a bit value of 1. Compare *clear*.

SIB

A byte following an instruction opcode that specifies address calculation based on scale (S), index (I), and base (B).

SIMD

Single instruction, multiple data. See *vector*.

SSE

Streaming SIMD extensions instruction set. See *128-bit media instructions* and *64-bit media instructions*.

SSE2

Extensions to the SSE instruction set. See *128-bit media instructions* and *64-bit media instructions*.

SSE3

Further extensions to the SSE instruction set. See *128-bit media instructions*.

sticky bit

A bit that is set or cleared by hardware and that remains in that state until explicitly changed by software.

TOP

The x87 top-of-stack pointer.

TPR

Task-priority register (CR8).

TSS

Task-state segment.

underflow

The condition in which a floating-point number is smaller in magnitude than the smallest nonzero, positive or negative number that can be represented in the data-type format being used.

vector

(1) A set of integer or floating-point values, called *elements*, that are packed into a single operand. Most of the 128-bit and 64-bit media instructions use vectors as operands. Vectors are also called *packed* or *SIMD* (single-instruction multiple-data) operands.

(2) An index into an interrupt descriptor table (IDT), used to access exception handlers. Compare *exception*.

virtual-8086 mode

A submode of *legacy mode*.

word

Two bytes, or 16 bits.

x86

See *legacy x86*.

Registers

In the following list of registers, the names are used to refer either to a given register or to the contents of that register:

AH–DH

The high 8-bit AH, BH, CH, and DH registers. Compare *AL–DL*.

AL–DL

The low 8-bit AL, BL, CL, and DL registers. Compare *AH–DH*.

AL–r15B

The low 8-bit AL, BL, CL, DL, SIL, DIL, BPL, SPL, and R8B–R15B registers, available in 64-bit mode.

BP

Base pointer register.

CR_n

Control register number *n*.

CS

Code segment register.

eAX–eSP

The 16-bit AX, BX, CX, DX, DI, SI, BP, and SP registers or the 32-bit EAX, EBX, ECX, EDX, EDI, ESI, EBP, and ESP registers. Compare *rAX–rSP*.

EFER

Extended features enable register.

eFLAGS

16-bit or 32-bit flags register. Compare *rFLAGS*.

EFLAGS

32-bit (extended) flags register.

eIP

16-bit or 32-bit instruction-pointer register. Compare *rIP*.

EIP

32-bit (extended) instruction-pointer register.

FLAGS

16-bit flags register.

GDTR

Global descriptor table register.

GPRs

General-purpose registers. For the 16-bit data size, these are AX, BX, CX, DX, DI, SI, BP, and SP. For the 32-bit data size, these are EAX, EBX, ECX, EDX, EDI, ESI, EBP, and ESP. For

the 64-bit data size, these include RAX, RBX, RCX, RDX, RDI, RSI, RBP, RSP, and R8–R15.

IDTR

Interrupt descriptor table register.

IP

16-bit instruction-pointer register.

LDTR

Local descriptor table register.

MSR

Model-specific register.

r8–r15

The 8-bit R8B–R15B registers, or the 16-bit R8W–R15W registers, or the 32-bit R8D–R15D registers, or the 64-bit R8–R15 registers.

rAX–rSP

The 16-bit AX, BX, CX, DX, DI, SI, BP, and SP registers, or the 32-bit EAX, EBX, ECX, EDX, EDI, ESI, EBP, and ESP registers, or the 64-bit RAX, RBX, RCX, RDX, RDI, RSI, RBP, and RSP registers. Replace the placeholder *r* with nothing for 16-bit size, “E” for 32-bit size, or “R” for 64-bit size.

RAX

64-bit version of the EAX register.

RBP

64-bit version of the EBP register.

RBX

64-bit version of the EBX register.

RCX

64-bit version of the ECX register.

RDI

64-bit version of the EDI register.

RDX

64-bit version of the EDX register.

rFLAGS

16-bit, 32-bit, or 64-bit flags register. Compare *RFLAGS*.

RFLAGS

64-bit flags register. Compare *rFLAGS*.

rIP

16-bit, 32-bit, or 64-bit instruction-pointer register. Compare *RIP*.

RIP

64-bit instruction-pointer register.

RSI

64-bit version of the ESI register.

RSP

64-bit version of the ESP register.

SP

Stack pointer register.

SS

Stack segment register.

TPR

Task priority register, a new register introduced in the AMD64 architecture to speed interrupt management.

TR

Task register.

Endian Order

The x86 and AMD64 architectures address memory using little-endian byte-ordering. Multibyte values are stored with their least-significant byte at the lowest byte address, and they are illustrated with their least significant byte at the right side. Strings are illustrated in reverse order, because the addresses of their bytes increase from right to left.

Related Documents

- Peter Abel, *IBM PC Assembly Language and Programming*, Prentice-Hall, Englewood Cliffs, NJ, 1995.
- Rakesh Agarwal, *80x86 Architecture & Programming: Volume II*, Prentice-Hall, Englewood Cliffs, NJ, 1991.

- AMD data sheets and application notes for particular hardware implementations of the AMD64 architecture.
- AMD, *AMD-K6® MMX™ Enhanced Processor Multimedia Technology*, Sunnyvale, CA, 2000.
- AMD, *3DNow!™ Technology Manual*, Sunnyvale, CA, 2000.
- AMD, *AMD Extensions to the 3DNow!™ and MMX™ Instruction Sets*, Sunnyvale, CA, 2000.
- Don Anderson and Tom Shanley, *Pentium® Processor System Architecture*, Addison-Wesley, New York, 1995.
- Nabajyoti Barkakati and Randall Hyde, *Microsoft Macro Assembler Bible*, Sams, Carmel, Indiana, 1992.
- Barry B. Brey, *8086/8088, 80286, 80386, and 80486 Assembly Language Programming*, Macmillan Publishing Co., New York, 1994.
- Barry B. Brey, *Programming the 80286, 80386, 80486, and Pentium Based Personal Computer*, Prentice-Hall, Englewood Cliffs, NJ, 1995.
- Ralf Brown and Jim Kyle, *PC Interrupts*, Addison-Wesley, New York, 1994.
- Penn Brumm and Don Brumm, *80386/80486 Assembly Language Programming*, Windcrest McGraw-Hill, 1993.
- Geoff Chappell, *DOS Internals*, Addison-Wesley, New York, 1994.
- Chips and Technologies, Inc. *Super386 DX Programmer's Reference Manual*, Chips and Technologies, Inc., San Jose, 1992.
- John Crawford and Patrick Gelsinger, *Programming the 80386*, Sybex, San Francisco, 1987.
- Cyrix Corporation, *5x86 Processor BIOS Writer's Guide*, Cyrix Corporation, Richardson, TX, 1995.
- Cyrix Corporation, *M1 Processor Data Book*, Cyrix Corporation, Richardson, TX, 1996.
- Cyrix Corporation, *MX Processor MMX Extension Opcode Table*, Cyrix Corporation, Richardson, TX, 1996.
- Cyrix Corporation, *MX Processor Data Book*, Cyrix Corporation, Richardson, TX, 1997.
- Ray Duncan, *Extending DOS: A Programmer's Guide to Protected-Mode DOS*, Addison Wesley, NY, 1991.

- William B. Giles, *Assembly Language Programming for the Intel 80xxx Family*, Macmillan, New York, 1991.
- Frank van Gilluwe, *The Undocumented PC*, Addison-Wesley, New York, 1994.
- John L. Hennessy and David A. Patterson, *Computer Architecture*, Morgan Kaufmann Publishers, San Mateo, CA, 1996.
- Thom Hogan, *The Programmer's PC Sourcebook*, Microsoft Press, Redmond, WA, 1991.
- Hal Katircioglu, *Inside the 486, Pentium®, and Pentium Pro*, Peer-to-Peer Communications, Menlo Park, CA, 1997.
- IBM Corporation, *486SLC Microprocessor Data Sheet*, IBM Corporation, Essex Junction, VT, 1993.
- IBM Corporation, *486SLC2 Microprocessor Data Sheet*, IBM Corporation, Essex Junction, VT, 1993.
- IBM Corporation, *80486DX2 Processor Floating Point Instructions*, IBM Corporation, Essex Junction, VT, 1995.
- IBM Corporation, *80486DX2 Processor BIOS Writer's Guide*, IBM Corporation, Essex Junction, VT, 1995.
- IBM Corporation, *Blue Lightening 486DX2 Data Book*, IBM Corporation, Essex Junction, VT, 1994.
- Institute of Electrical and Electronics Engineers, *IEEE Standard for Binary Floating-Point Arithmetic*, ANSI/IEEE Std 754-1985.
- Institute of Electrical and Electronics Engineers, *IEEE Standard for Radix-Independent Floating-Point Arithmetic*, ANSI/IEEE Std 854-1987.
- Muhammad Ali Mazidi and Janice Gillispie Mazidi, *80X86 IBM PC and Compatible Computers*, Prentice-Hall, Englewood Cliffs, NJ, 1997.
- Hans-Peter Messmer, *The Indispensable Pentium Book*, Addison-Wesley, New York, 1995.
- Karen Miller, *An Assembly Language Introduction to Computer Architecture: Using the Intel Pentium®*, Oxford University Press, New York, 1999.
- Stephen Morse, Eric Isaacson, and Douglas Albert, *The 80386/387 Architecture*, John Wiley & Sons, New York, 1987.
- NexGen Inc., *Nx586 Processor Data Book*, NexGen Inc., Milpitas, CA, 1993.

- NexGen Inc., *Nx686 Processor Data Book*, NexGen Inc., Milpitas, CA, 1994.
- Bipin Patwardhan, *Introduction to the Streaming SIMD Extensions in the Pentium® III*, www.x86.org/articles/sse_pt1/simd1.htm, June, 2000.
- Peter Norton, Peter Aitken, and Richard Wilton, *PC Programmer's Bible*, Microsoft® Press, Redmond, WA, 1993.
- *PharLap 386\ASM Reference Manual*, Pharlap, Cambridge MA, 1993.
- *PharLap TNT DOS-Extender Reference Manual*, Pharlap, Cambridge MA, 1995.
- Sen-Cuo Ro and Sheau-Chuen Her, *i386/i486 Advanced Programming*, Van Nostrand Reinhold, New York, 1993.
- Jeffrey P. Royer, *Introduction to Protected Mode Programming*, course materials for an onsite class, 1992.
- Tom Shanley, *Protected Mode System Architecture*, Addison Wesley, NY, 1996.
- SGS-Thomson Corporation, *80486DX Processor SMM Programming Manual*, SGS-Thomson Corporation, 1995.
- Walter A. Triebel, *The 80386DX Microprocessor*, Prentice-Hall, Englewood Cliffs, NJ, 1992.
- John Wharton, *The Complete x86*, MicroDesign Resources, Sebastopol, California, 1994.
- Web sites and newsgroups:
 - www.amd.com
 - news.comp.arch
 - news.comp.lang.asm.x86
 - news.intel.microprocessors
 - news.microsoft

1 Overview of the AMD64 Architecture

1.1 Introduction

The AMD64 architecture is a simple yet powerful 64-bit, backward-compatible extension of the industry-standard (legacy) x86 architecture. It adds 64-bit addressing and expands register resources to support higher performance for recompiled 64-bit programs, while supporting legacy 16-bit and 32-bit applications and operating systems without modification or recompilation. It is the architectural basis on which new processors can provide seamless, high-performance support for both the vast body of existing software and new 64-bit software required for higher-performance applications.

The need for a 64-bit x86 architecture is driven by applications that address large amounts of virtual and physical memory, such as high-performance servers, database management systems, and CAD tools. These applications benefit from both 64-bit addresses and an increased number of registers. The small number of registers available in the legacy x86 architecture limits performance in computation-intensive applications. Increasing the number of registers provides a performance boost to many such applications.

1.1.1 New Features

The AMD64 architecture introduces these new features:

- *Register Extensions (see Figure 1-1 on page 2):*
 - 8 new general-purpose registers (GPRs).
 - All 16 GPRs are 64 bits wide.
 - 8 new 128-bit XMM registers.
 - Uniform byte-register addressing for all GPRs.
 - A new instruction prefix (REX) accesses the extended registers.
- *Long Mode (see Table 1-1 on page 3):*
 - Up to 64 bits of virtual address.
 - 64-bit instruction pointer (RIP).
 - New instruction-pointer-relative data-addressing mode.
 - Flat address space.

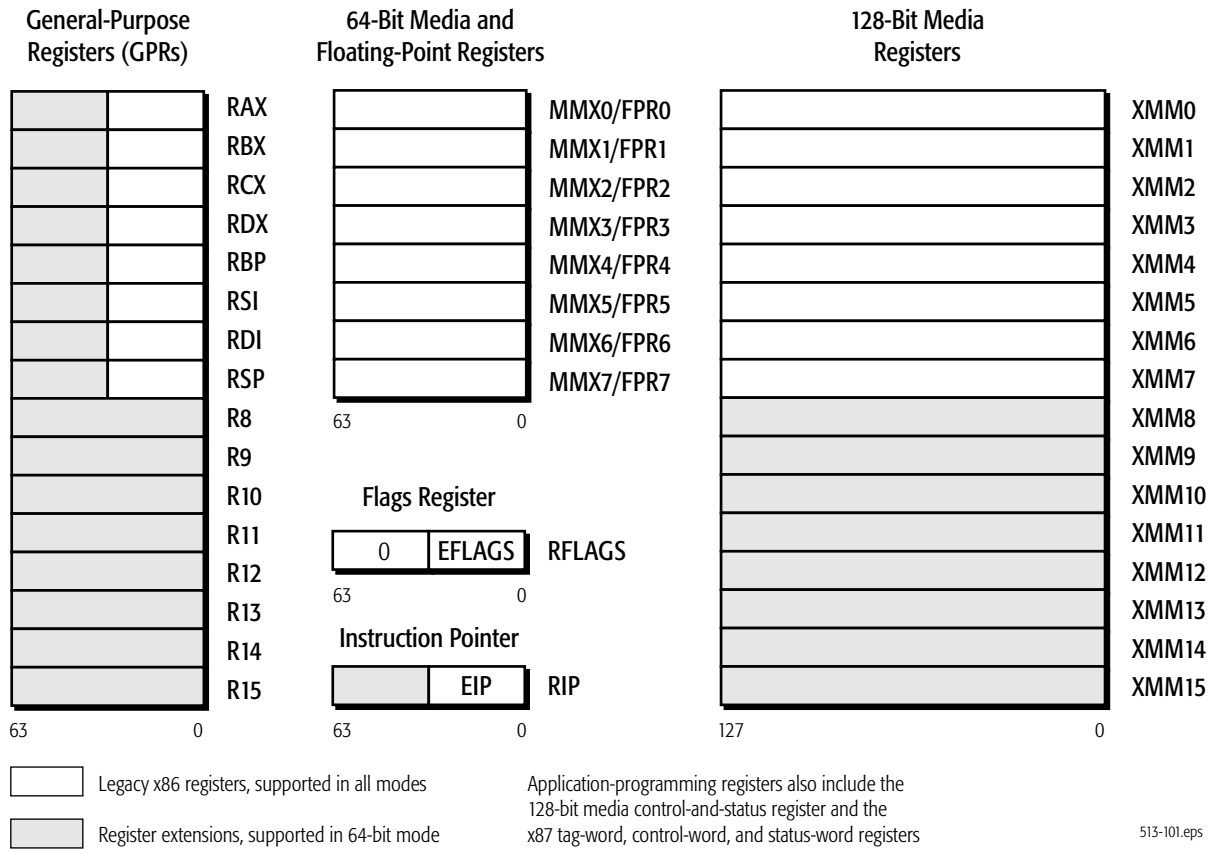

Figure 1-1. Application-Programming Register Set

Table 1-1. Operating Modes

Operating Mode		Operating System Required	Application Recompile Required	Defaults		Register Extensions	Typical
				Address Size (bits)	Operand Size (bits)		GPR Width (bits)
Long Mode	64-Bit Mode	New 64-bit OS	yes	64	32	yes	64
	Compatibility Mode		no	32		no	32
				16	16		16
Legacy Mode	Protected Mode	Legacy 32-bit OS	no	32	32	no	32
				16	16		
	Virtual-8086 Mode			16	16		16
	Real Mode	Legacy 16-bit OS					

1.1.2 Registers

Table 1-2 on page 4 compares the register and stack resources available to application software, by operating mode. The left set of columns shows the legacy x86 resources, which are available in the AMD64 architecture's legacy and compatibility modes. The right set of columns shows the comparable resources in 64-bit mode. Gray shading indicates differences between the modes. These register differences (not including stack-width difference) represent the *register extensions* shown in Figure 1-1.

Table 1-2. Application Registers and Stack, by Operating Mode

Register or Stack	Legacy and Compatibility Modes			64-Bit Mode ¹		
	Name	Number	Size (bits)	Name	Number	Size (bits)
General-Purpose Registers (GPRs) ²	EAX, EBX, ECX, EDX, EBP, ESI, EDI, ESP	8	32	RAX, RBX, RCX, RDX, RBP, RSI, RDI, RSP, R8–R15	16	64
128-Bit XMM Registers	XMM0–XMM7	8	128	XMM0–XMM15	16	128
64-Bit MMX Registers	MMX0–MMX7 ³	8	64	MMX0–MMX7 ³	8	64
x87 Registers	FPR0–FPR7 ³	8	80	FPR0–FPR7 ³	8	80
Instruction Pointer ²	EIP	1	32	RIP	1	64
Flags ²	EFLAGS	1	32	RFLAGS	1	64
Stack	–		16 or 32	–		64

Note:

1. Gray-shaded entries indicate differences between the modes. These differences (except stack-width difference) are the AMD64 architecture's register extensions.
2. This list of GPRs shows only the 32-bit registers. The 16-bit and 8-bit mappings of the 32-bit registers are also accessible, as described in "Registers" on page 27.
3. The MMX0–MMX7 registers are mapped onto the FPR0–FPR7 physical registers, as shown in Figure 1-1. The x87 stack registers, ST(0)–ST(7), are the logical mappings of the FPR0–FPR7 physical registers.

As Table 1-2 shows, the legacy x86 architecture (called *legacy mode* in the AMD64 architecture) supports eight GPRs. In reality, however, the general use of at least four registers (EBP, ESI, EDI, and ESP) is compromised because they serve special purposes when executing many instructions. The AMD64 architecture's addition of eight new GPRs—and the increased width of these registers from 32 bits to 64 bits—allows compilers to substantially improve software performance. Compilers have more flexibility in using registers to hold variables. Compilers can also minimize memory traffic—and thus boost performance—by localizing work within the GPRs.

1.1.3 Instruction Set

The AMD64 architecture supports the full legacy x86 instruction set, and it adds a few new instructions to support long mode (see Table 1-1 for a summary of operating modes). The application-programming instructions are organized and described in the following subsets:

- *General-Purpose Instructions*—These are the basic x86 integer instructions used in virtually all programs. Most of

these instructions load, store, or operate on data located in the general-purpose registers (GPRs) or memory. Some of the instructions alter sequential program flow program by branching to other program locations.

- *128-Bit Media Instructions*—These are the *streaming SIMD extension* (SSE and SSE2) instructions that load, store, or operate on data located primarily in the 128-bit XMM registers. They perform integer and floating-point operations on vector (packed) and scalar data types. Because the vector instructions can independently and simultaneously perform a single operation on multiple sets of data, they are called *single-instruction, multiple-data* (SIMD) instructions. They are useful for high-performance media and scientific applications that operate on blocks of data.
- *64-Bit Media Instructions*—These are the *multimedia extension* (MMX™ technology) and AMD 3DNow!™ technology instructions. They load, store, or operate on data located primarily on the 64-bit MMX registers. Like their 128-bit counterparts, described above, they perform integer and floating-point operations on vector (packed) and scalar data types. Thus, they are also SIMD instructions and are useful in media applications that operate on blocks of data.
- *x87 Floating-Point Instructions*—These are the floating-point instructions used in legacy x87 applications. They load, store, or operate on data located in the x87 registers.

Some of these application-programming instructions bridge two or more of the above subsets. For example, there are instructions that move data between the general-purpose registers and the XMM or MMX registers, and many of the integer vector (packed) instructions can operate on either XMM or MMX registers, although not simultaneously. If instructions bridge two or more subsets, their descriptions are repeated in all subsets to which they apply.

1.1.4 **Media Instructions**

Media applications—such as image processing, music synthesis, speech recognition, full-motion video, and 3D graphics rendering—share certain characteristics:

- They process large amounts of data.
- They often perform the same sequence of operations repeatedly across the data.

- The data are often represented as small quantities, such as 8 bits for pixel values, 16 bits for audio samples, and 32 bits for object coordinates in floating-point format.

The 128-bit and 64-bit media instructions are designed to accelerate these applications. The instructions use a form of vector (or packed) parallel processing known as single-instruction, multiple data (SIMD) processing. This vector technology has the following characteristics:

- A single register can hold multiple independent pieces of data. For example, a single 128-bit XMM register can hold 16 8-bit integer data elements, or four 32-bit single-precision floating-point data elements.
- The vector instructions can operate on all data elements in a register, independently and simultaneously. For example, a PADDB instruction operating on byte elements of two vector operands in 128-bit XMM registers performs 16 simultaneous additions and returns 16 independent results in a single operation.

128-bit and 64-bit media instructions take SIMD vector technology a step further by including special instructions that perform operations commonly found in media applications. For example, a graphics application that adds the brightness values of two pixels must prevent the add operation from wrapping around to a small value if the result overflows the destination register, because an overflow result can produce unexpected effects such as a dark pixel where a bright one is expected. The 128-bit and 64-bit media instructions include saturating-arithmetic instructions to simplify this type of operation. A result that otherwise would wrap around due to overflow or underflow is instead forced to saturate at the largest or smallest value that can be represented in the destination register.

1.1.5 Floating-Point Instructions

The AMD64 architecture provides three floating-point instruction subsets, using three distinct register sets:

- *128-Bit Media Instructions* support 32-bit single-precision and 64-bit double-precision floating-point operations, in addition to integer operations. Operations on both vector data and scalar data are supported, with a dedicated floating-point exception-reporting mechanism. These floating-point operations comply with the IEEE-754 standard.

- *64-Bit Media Instructions* (the subset of 3DNow! technology instructions) support single-precision floating-point operations. Operations on both vector data and scalar data are supported, but these instructions do not support floating-point exception reporting.
- *x87 Floating-Point Instructions* support single-precision, double-precision, and 80-bit extended-precision floating-point operations. Only scalar data are supported, with a dedicated floating-point exception-reporting mechanism. The x87 floating-point instructions contain special instructions for performing trigonometric and logarithmic transcendental operations. The single-precision and double-precision floating-point operations comply with the IEEE-754 standard.

Maximum floating-point performance can be achieved using the 128-bit media instructions. One of these vector instructions can support up to four single-precision (or two double-precision) operations in parallel. In 64-bit mode, the AMD64 architecture doubles the number of legacy XMM registers from 8 to 16.

Applications gain additional benefits using the 64-bit media and x87 instructions. The separate register sets supported by these instructions relieve pressure on the XMM registers available to the 128-bit media instructions. This provides application programs with three distinct sets of floating-point registers. In addition, certain high-end implementations of the AMD64 architecture may support 128-bit media, 64-bit media, and x87 instructions with separate execution units.

1.2 Modes of Operation

Table 1-1 on page 3 summarizes the modes of operation supported by the AMD64 architecture. In most cases, the default address and operand sizes can be overridden with instruction prefixes. The register extensions shown in the second-from-right column of Table 1-1 are those illustrated in Figure 1-1 on page 2.

1.2.1 Long Mode

Long mode is an extension of legacy protected mode. Long mode consists of two submodes: *64-bit mode* and *compatibility mode*. 64-bit mode supports all of the new features and register extensions of the AMD64 architecture. Compatibility mode

supports binary compatibility with existing 16-bit and 32-bit applications. Long mode does not support legacy real mode or legacy virtual-8086 mode, and it does not support hardware task switching.

Throughout this document, references to *long mode* refer to both *64-bit mode* and *compatibility mode*. If a function is specific to either of these submodes, then the name of the specific submode is used instead of the name *long mode*.

1.2.2 64-Bit Mode

64-bit mode—a submode of long mode—supports the full range of 64-bit virtual-addressing and register-extension features. This mode is enabled by the operating system on an individual code-segment basis. Because 64-bit mode supports a 64-bit virtual-address space, it requires a new 64-bit operating system and tool chain. Existing application binaries can run without recompilation in compatibility mode, under an operating system that runs in 64-bit mode, or the applications can also be recompiled to run in 64-bit mode.

Addressing features include a 64-bit instruction pointer (RIP) and a new RIP-relative data-addressing mode. This mode accommodates modern operating systems by supporting only a flat address space, with single code, data, and stack space.

Register Extensions. 64-bit mode implements register extensions through a new group of instruction prefixes, called REX prefixes. These extensions add eight GPRs (R8–R15), widen all GPRs to 64 bits, and add eight 128-bit XMM registers (XMM8–XMM15).

The REX instruction prefixes also provide a new byte-register capability that makes the low byte of any of the sixteen GPRs available for byte operations. This results in a uniform set of byte, word, doubleword, and quadword registers that is better suited to compiler register-allocation.

64-Bit Addresses and Operands. In 64-bit mode, the default virtual-address size is 64 bits (implementations can have fewer). The default operand size for most instructions is 32 bits. For most instructions, these defaults can be overridden on an instruction-by-instruction basis using instruction prefixes. REX prefixes specify the 64-bit operand size and new registers.

RIP-Relative Data Addressing. 64-bit mode supports data addressing relative to the 64-bit instruction pointer (RIP). The legacy x86

architecture supports IP-relative addressing only in control-transfer instructions. RIP-relative addressing improves the efficiency of position-independent code and code that addresses global data.

Opcodes. A few instruction opcodes and prefix bytes are redefined to allow register extensions and 64-bit addressing. These differences are described in “General-Purpose Instructions in 64-Bit Mode” in Volume 3 and “Differences Between Long Mode and Legacy Mode” in Volume 3.

1.2.3 **Compatibility Mode**

Compatibility mode—the second submode of long mode—allows 64-bit operating systems to run existing 16-bit and 32-bit x86 applications. These legacy applications run in compatibility mode without recompilation.

Applications running in compatibility mode use 32-bit or 16-bit addressing and can access the first 4GB of virtual-address space. Legacy x86 instruction prefixes toggle between 16-bit and 32-bit address and operand sizes.

As with 64-bit mode, compatibility mode is enabled by the operating system on an individual code-segment basis. Unlike 64-bit mode, however, x86 segmentation functions the same as in the legacy x86 architecture, using 16-bit or 32-bit protected-mode semantics. From the application viewpoint, compatibility mode looks like the legacy x86 protected-mode environment. From the operating-system viewpoint, however, address translation, interrupt and exception handling, and system data structures use the 64-bit long-mode mechanisms.

1.2.4 **Legacy Mode**

Legacy mode preserves binary compatibility not only with existing 16-bit and 32-bit applications but also with existing 16-bit and 32-bit operating systems. Legacy mode consists of the following three submodes:

- *Protected Mode*—Protected mode supports 16-bit and 32-bit programs with memory segmentation, optional paging, and privilege-checking. Programs running in protected mode can access up to 4GB of memory space.
- *Virtual-8086 Mode*—Virtual-8086 mode supports 16-bit real-mode programs running as tasks under protected mode. It uses a simple form of memory segmentation, optional paging, and limited protection-checking. Programs running in virtual-8086 mode can access up to 1MB of memory space.

- *Real Mode*—Real mode supports 16-bit programs using simple register-based memory segmentation. It does not support paging or protection-checking. Programs running in real mode can access up to 1MB of memory space.

Legacy mode is compatible with existing 32-bit processor implementations of the x86 architecture. Processors that implement the AMD64 architecture boot in legacy real mode, just like processors that implement the legacy x86 architecture.

Throughout this document, references to *legacy mode* refer to all three submodes—*protected mode*, *virtual-8086 mode*, and *real mode*. If a function is specific to either of these submodes, then the name of the specific submode is used instead of the name *legacy mode*.

2 Memory Model

This chapter describes the memory characteristics that apply to application software in the various operating modes of the AMD64 architecture. These characteristics apply to all instructions in the architecture. Several additional system-level details about memory and cache management are described in Volume 2.

2.1 Memory Organization

2.1.1 Virtual Memory

Virtual memory consists of the entire address space available to programs. It is a large linear-address space that is translated by a combination of hardware and operating-system software to a smaller physical-address space, parts of which are located in memory and parts on disk or other external storage media.

Figure 2-1 on page 12 shows how the virtual-memory space is treated in the two submodes of long mode:

- *64-bit mode*—This mode uses a flat segmentation model of virtual memory. The 64-bit virtual-memory space is treated as a single, flat (unsegmented) address space. Program addresses access locations that can be anywhere in the linear 64-bit address space. The operating system can use separate selectors for code, stack, and data segments for memory-protection purposes, but the base address of all these segments is always 0. (For an exception to this general rule, see “FS and GS as Base of Address Calculation” on page 20.)
- *Compatibility mode*—This mode uses a protected, multi-segment model of virtual memory, just as in legacy protected mode. The 32-bit virtual-memory space is treated as a segmented set of address spaces for code, stack, and data segments, each with its own base address and protection parameters. A segmented space is specified by adding a segment selector to an address.

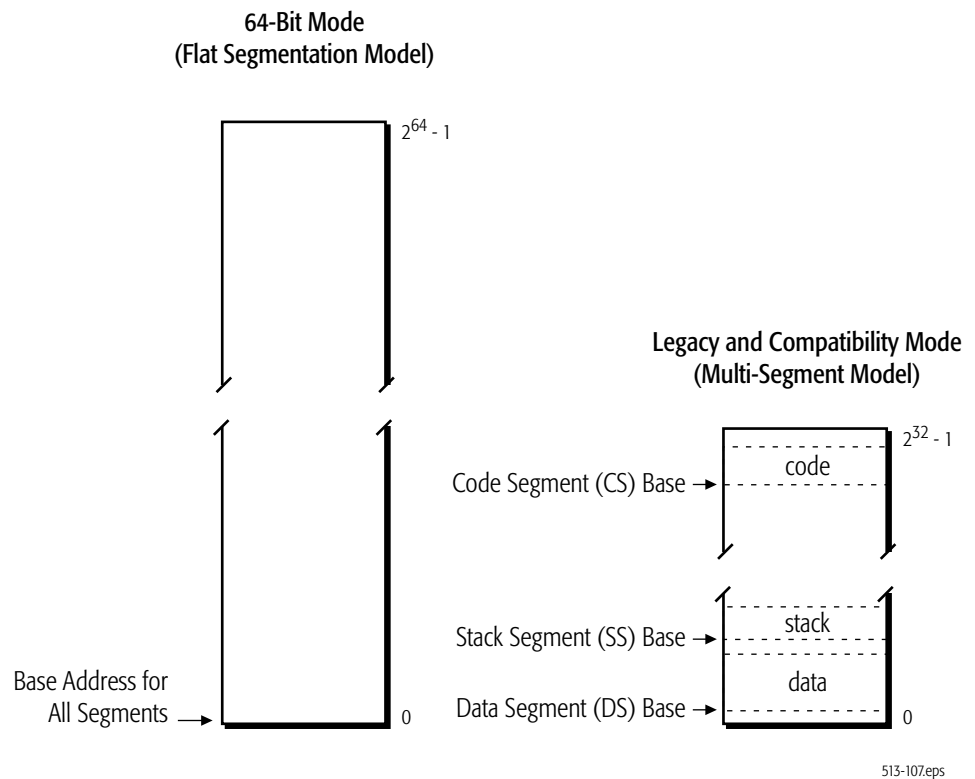

Figure 2-1. Virtual-Memory Segmentation

Segmented memory has been used as a method by which operating systems could isolate programs, and the data used by programs, from each other in an effort to increase the reliability of systems running multiple programs simultaneously. However, most modern operating systems do not use the segmentation features available in the legacy x86 architecture. Instead, these operating systems handle segmentation functions entirely in software. For this reason, the AMD64 architecture dispenses with most of the legacy segmentation functions in 64-bit mode. This allows new 64-bit operating systems to be coded more simply, and it supports more efficient management of multi-programming environments than is possible in the legacy x86 architecture.

2.1.2 Segment Registers

Segment registers hold the selectors used to access memory segments. Figure 2-2 on page 13 shows the application-visible portion of the segment registers. In legacy and compatibility modes, all segment registers are accessible to software. In 64-bit mode, only the CS, FS, and GS segments are recognized by

the processor, and software can use the FS and GS segment-base registers as base registers for address calculation, as described in “FS and GS as Base of Address Calculation” on page 20. For references to the DS, ES, or SS segments in 64-bit mode, the processor assumes that the base for each of these segments is zero, neither their segment limit nor attributes are checked, and the processor simply checks that all such addresses are in canonical form, as described in “64-bit Canonical Addresses” on page 18.

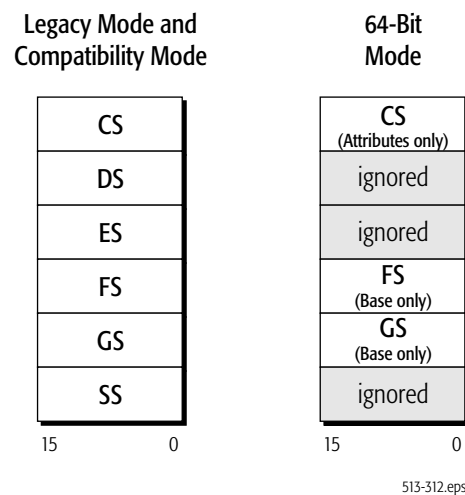

Figure 2-2. Segment Registers

For details on segmentation and the segment registers, see “Segmented Virtual Memory” in Volume 2.

2.1.3 Physical Memory

Physical memory is the installed memory (excluding cache memory) in a particular computer system that can be accessed through the processor’s bus interface. The maximum size of the physical memory space is determined by the number of address bits on the bus interface. In a virtual-memory system, the large virtual-address space (also called *linear-address space*) is translated to a smaller physical-address space by a combination of segmentation and paging hardware and software.

Segmentation is illustrated in Figure 2-1 on page 12. Paging is a mechanism for translating linear (virtual) addresses into fixed-size blocks called *pages*, which the operating system can move, as needed, between memory and external storage media

(typically disk). The AMD64 architecture supports an expanded version of the legacy x86 paging mechanism, one that is able to translate the full 64-bit virtual-address space into the physical-address space supported by the particular implementation.

2.1.4 Memory Management

Memory management consists of the methods by which addresses generated by programs are translated via segmentation and/or paging into addresses in physical memory. Memory management is not visible to application programs. It is handled by the operating system and processor hardware. The following description gives a very brief overview of these functions. Details are given in “System-Management Instructions” in Volume 2.

Long-Mode Memory Management. Figure 2-3 shows the flow, from top to bottom, of memory management functions performed in the two submodes of long mode.

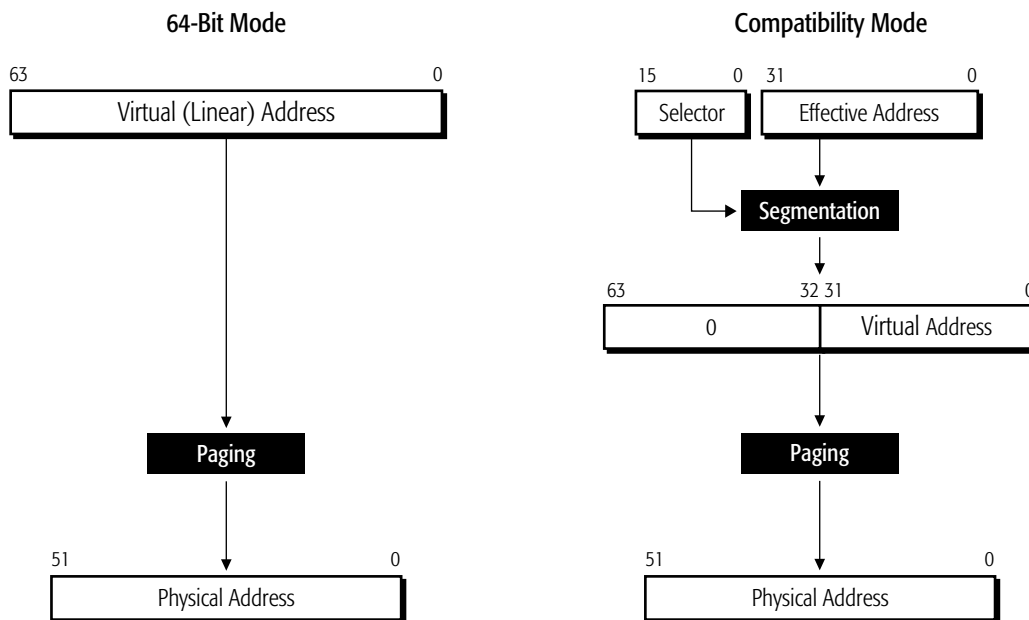

513-184.eps

Figure 2-3. Long-Mode Memory Management

In 64-bit mode, programs generate virtual (linear) addresses that can be up to 64 bits in size. The virtual addresses are

passed to the long-mode paging function, which generates physical addresses that can be up to 52 bits in size. (Specific implementations of the architecture can support fewer virtual-address and physical-address sizes.)

In compatibility mode, legacy 16-bit and 32-bit applications run using legacy x86 protected-mode segmentation semantics. The 16-bit or 32-bit effective addresses generated by programs are combined with their segments to produce 32-bit virtual (linear) addresses that are zero-extended to a maximum of 64 bits. The paging that follows is the same long-mode paging function used in 64-bit mode. It translates the virtual addresses into physical addresses. The combination of segment selector and effective address is also called a *logical address* or *far pointer*. The *virtual address* is also called the *linear address*.

Legacy-Mode Memory Management. Figure 2-4 shows the memory-management functions performed in the three submodes of legacy mode.

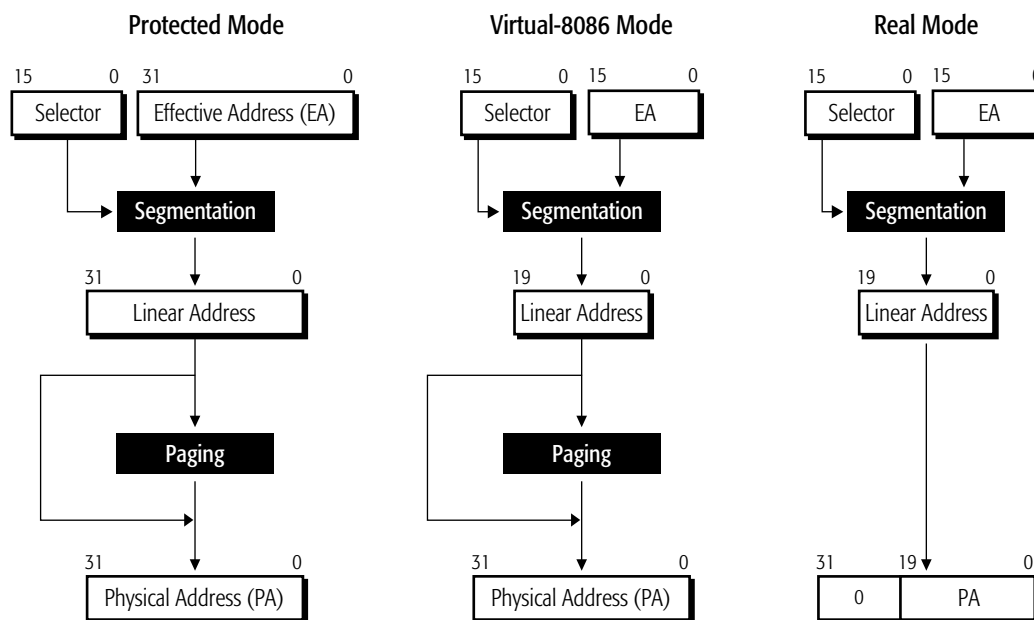

513-185.eps

Figure 2-4. Legacy-Mode Memory Management

The memory-management functions differ, depending on the submode, as follows:

- *Protected Mode*—Protected mode supports 16-bit and 32-bit programs with table-based memory segmentation, paging, and privilege-checking. The segmentation function takes 32-bit effective addresses and 16-bit segment selectors and produces 32-bit linear addresses into one of 16K memory segments, each of which can be up to 4GB in size. Paging is optional. The 32-bit physical addresses are either produced by the paging function or the linear addresses are used without modification as physical addresses.
- *Virtual-8086 Mode*—Virtual-8086 mode supports 16-bit programs running as tasks under protected mode. 20-bit linear addresses are formed in the same way as in real mode, but they can optionally be translated through the paging function to form 32-bit physical addresses that access up to 4GB of memory space.
- *Real Mode*—Real mode supports 16-bit programs using register-based shift-and-add segmentation, but it does not support paging. Sixteen-bit effective addresses are zero-extended and added to a 16-bit segment-base address that is left-shifted four bits, producing a 20-bit linear address. The linear address is zero-extended to a 32-bit physical address that can access up to 1MB of memory space.

2.2 Memory Addressing

2.2.1 Byte Ordering

Instructions and data are stored in memory in *little-endian* byte order. Little-endian ordering places the least-significant byte of the instruction or data item at the lowest memory address and the most-significant byte at the highest memory address.

Figure 2-5 on page 17 shows a generalization of little-endian memory and register images of a quadword data type. The least-significant byte is at the lowest address in memory and at the right-most byte location of the register image.

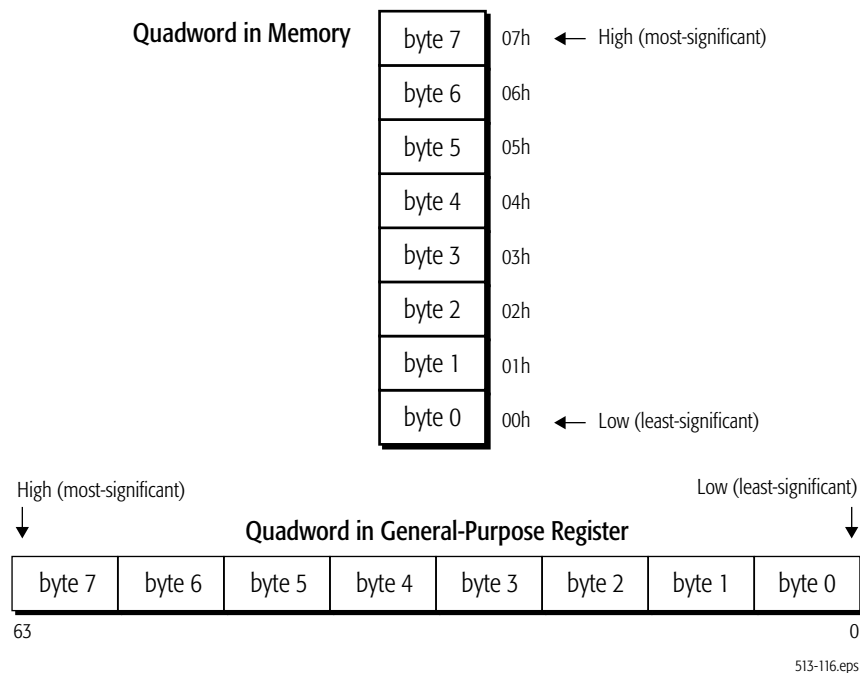
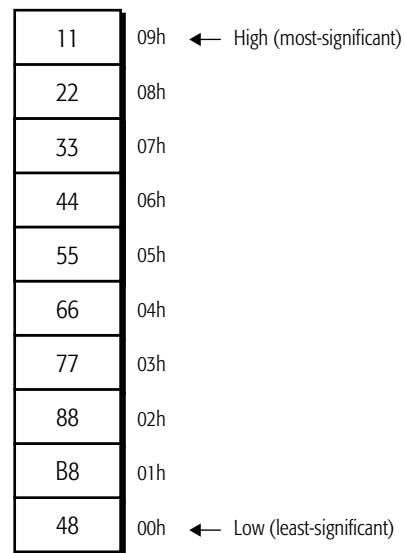

Figure 2-5. Byte Ordering

Figure 2-6 on page 18 shows the memory image of a 10-byte instruction. Instructions are byte data types. They are read from memory one byte at a time, starting with the least-significant byte (lowest address). For example, the following instruction specifies the 64-bit instruction MOV RAX, 1122334455667788 instruction that consists of the following ten bytes:

```
48 B8 8877665544332211
```

48 is a REX instruction prefix that specifies a 64-bit operand size, B8 is the opcode that—together with the REX prefix—specifies the 64-bit RAX destination register, and 8877665544332211 is the 8-byte immediate value to be moved, where 88 represents the eighth (least-significant) byte and 11 represents the first (most-significant) byte. In memory, the REX prefix byte (48) would be stored at the lowest address, and the first immediate byte (11) would be stored at the highest instruction address.



513-186.eps

Figure 2-6. Example of 10-Byte Instruction in Memory

2.2.2 64-bit Canonical Addresses

Long mode defines 64 bits of virtual address, but implementations of the AMD64 architecture may support fewer bits of virtual address. Although implementations might not use all 64 bits of the virtual address, they check bits 63 through the most-significant implemented bit to see if those bits are all zeros or all ones. An address that complies with this property is said to be in *canonical address form*. If a virtual-memory reference is not in canonical form, the implementation causes a general-protection exception or stack fault.

2.2.3 Effective Addresses

Programs provide effective addresses to the hardware prior to segmentation and paging translations. Long-mode effective addresses are a maximum of 64 bits wide, as shown in Figure 2-3 on page 14. Programs running in compatibility mode generate (by default) 32-bit effective addresses, which the hardware zero-extends to 64 bits. Legacy-mode effective addresses, with no address-size override, are 32 or 16 bits wide, as shown in Figure 2-4. These sizes can be overridden with an address-size instruction prefix, as described in “Instruction Prefixes” on page 87.

There are five methods for generating effective addresses, depending on the specific instruction encoding:

- *Absolute Addresses*—These addresses are given as displacements (or offsets) from the base address of a data segment. They point directly to a memory location in the data segment.
- *Instruction-Relative Addresses*—These addresses are given as displacements (or offsets) from the current instruction pointer (IP), also called the program counter (PC). They are generated by control-transfer instructions. A displacement in the instruction encoding, or one read from memory, serves as an offset from the address that follows the transfer. See “RIP-Relative Addressing” on page 22 for details about RIP-relative addressing in 64-bit mode.
- *ModR/M Addressing*—These addresses are calculated using a scale, index, base, and displacement. Instruction encodings contain two bytes—MODR/M and optional SIB (scale, index, base) and a variable length displacement—that specify the variables for the calculation. The base and index values are contained in general-purpose registers specified by the SIB byte. The scale and displacement values are specified directly in the instruction encoding. Figure 2-7 shows the components of a complex-address calculation. The resultant effective address is added to the data-segment base address to form a linear address, as described in “Segmented Virtual Memory” in Volume 2. “Instruction Formats” in Volume 3 gives further details on specifying this form of address. The encoding of instructions specifies how the address is calculated.

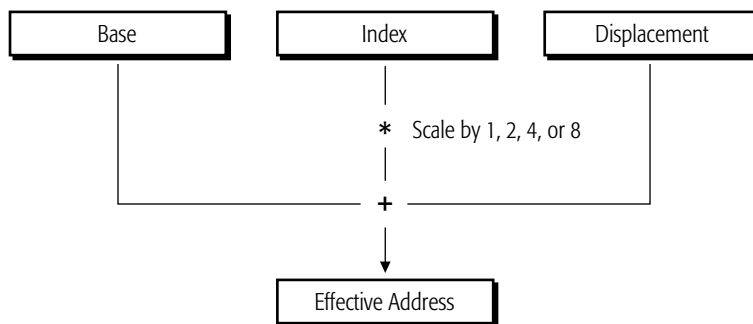

513-108.eps

Figure 2-7. Complex Address Calculation (Protected Mode)

- *Stack Addresses*—PUSH, POP, CALL, RET, IRET, and INT instructions implicitly use the stack pointer, which contains the address of the procedure stack. See “Stack Operation” on page 23 for details about the size of the stack pointer.
- *String Addresses*—String instructions generate sequential addresses using the rDI and rSI registers, as described in “Implicit Uses of GPRs” on page 34.

In 64-bit mode, with no address-size override, the size of effective-address calculations is 64 bits. An effective-address calculation uses 64-bit base and index registers and sign-extends displacements to 64 bits. Due to the flat address space in 64-bit mode, virtual addresses are equal to effective addresses. (For an exception to this general rule, see “FS and GS as Base of Address Calculation” on page 20.)

Long-Mode Zero-Extension of 16-Bit and 32-Bit Addresses. In long mode, all 16-bit and 32-bit address calculations are zero-extended to form 64-bit addresses. Address calculations are first truncated to the effective-address size of the current mode (64-bit mode or compatibility mode), as overridden by any address-size prefix. The result is then zero-extended to the full 64-bit address width.

Because of this, 16-bit and 32-bit applications running in compatibility mode can access only the low 4GB of the long-mode virtual-address space. Likewise, a 32-bit address generated in 64-bit mode can access only the low 4GB of the long-mode virtual-address space.

Displacements and immediates. In general, the maximum size of address displacements and immediate operands is 32 bits. They can be 8, 16, or 32 bits in size, depending on the instruction or, for displacements, the effective address size. In 64-bit mode, displacements are sign-extended to 64 bits during use, but their actual size (for value representation) remains a maximum of 32 bits. The same is true for immediates in 64-bit mode, when the operand size is 64 bits. However, support is provided in 64-bit mode for some 64-bit displacement and immediate forms of the MOV instruction.

FS and GS as Base of Address Calculation. In 64-bit mode, the FS and GS segment-base registers (unlike the DS, ES, and SS segment-base registers) can be used as non-zero data-segment base registers for address calculations, as described in “Segmented Virtual Memory” in Volume 2. 64-bit mode assumes all other

data-segment registers (DS, ES, and SS) have a base address of 0.

2.2.4 Address-Size Prefix

The default address size of an instruction is determined by the default-size (D) bit and long-mode (L) bit in the current code-segment descriptor (for details, see “Segmented Virtual Memory” in Volume 2). Application software can override the default address size in any operating mode by using the 67h address-size instruction prefix byte. The address-size prefix allows mixing 32-bit and 64-bit addresses on an instruction-by-instruction basis.

Table 2-1 shows the effects of using the address-size prefix in all operating modes. In 64-bit mode, the default address size is 64 bits. The address size can be overridden to 32 bits. 16-bit addresses are not supported in 64-bit mode. In compatibility and legacy modes, the address-size prefix works the same as in the legacy x86 architecture.

Table 2-1. Address-Size Prefixes

Operating Mode		Default Address Size (Bits)	Effective Address Size (Bits)	Address-Size Prefix (67h) ¹ Required?
Long Mode	64-Bit Mode	64	64	no
			32	yes
	Compatibility Mode	32	32	no
			16	yes
		16	32	yes
			16	no
Legacy Mode (Protected, Virtual-8086, or Real Mode)	32	32	no	
		16	yes	
	16	32	yes	
		16	no	
Note:				
1. “No” indicates that the default address size is used.				

2.2.5 RIP-Relative Addressing

RIP-relative addressing—that is, addressing relative to the 64-bit instruction pointer (also called program counter)—is available in 64-bit mode. The effective address is formed by adding the displacement to the 64-bit RIP of the next instruction.

In the legacy x86 architecture, addressing relative to the instruction pointer (IP or EIP) is available only in control-transfer instructions. In the 64-bit mode, any instruction that uses ModRM addressing (see “ModRM and SIB Bytes” in Volume 3) can use RIP-relative addressing. The feature is particularly useful for addressing data in position-independent code and for code that addresses global data.

Programs usually have many references to data, especially global data, that are not register-based. To load such a program, the loader typically selects a location for the program in memory and then adjusts the program’s references to global data based on the load location. RIP-relative addressing of data makes this adjustment unnecessary.

Range of RIP-Relative Addressing. Without RIP-relative addressing, instructions encoded with a ModRM byte address memory relative to zero. With RIP-relative addressing, instructions with a ModRM byte can address memory relative to the 64-bit RIP using a signed 32-bit displacement. This provides an offset range of $\pm 2\text{GB}$ from the RIP.

Effect of Address-Size Prefix on RIP-relative Addressing. RIP-relative addressing is enabled by 64-bit mode, not by a 64-bit address-size. Conversely, use of the address-size prefix does not disable RIP-relative addressing. The effect of the address-size prefix is to truncate and zero-extend the computed effective address to 32 bits, like any other addressing mode.

Encoding. For details on instruction encoding of RIP-relative addressing, see in “RIP-Relative Addressing” in Volume 3.

2.3 Pointers

Pointers are variables that contain addresses rather than data. They are used by instructions to reference memory. Instructions access data using near and far pointers. Stack pointers locate the current stack.

2.3.1 Near and Far Pointers

Near pointers contain only an effective address, which is used as an offset into the current segment. Far pointers contain both an effective address and a segment selector that specifies one of several segments. Figure 2-8 illustrates the two types of pointers.



513-109.eps

Figure 2-8. Near and Far Pointers

In 64-bit mode, the AMD64 architecture supports only the flat-memory model in which there is only one data segment, so the effective address is used as the virtual (linear) address and far pointers are not needed. In compatibility mode and legacy protected mode, the AMD64 architecture supports multiple memory segments, so effective addresses can be combined with segment selectors to form far pointers, and the terms *logical address* (segment selector and effective address) and *far pointer* are synonyms. Near pointers can also be used in compatibility mode and legacy mode.

2.4 Stack Operation

A stack is a portion of a stack segment in memory that is used to link procedures. Software conventions typically define stacks using a *stack frame*, which consists of two registers—a *stack-frame base pointer* (rBP) and a *stack pointer* (rSP)—as shown in Figure 2-9 on page 24. These stack pointers can be either near pointers or far pointers.

The stack-segment (SS) register, points to the base address of the current stack segment. The stack pointers contain offsets from the base address of the current stack segment. All instructions that address memory using the rBP or rSP registers cause the processor to access the current stack segment.

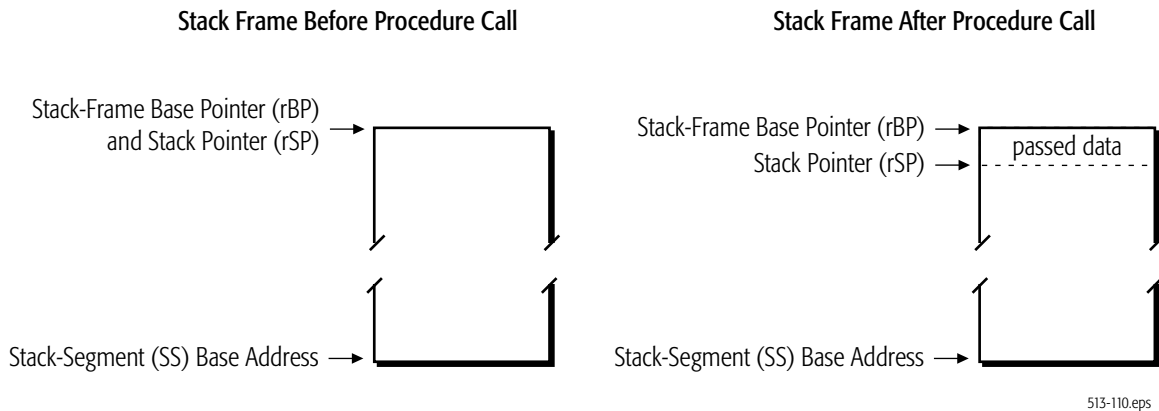

Figure 2-9. Stack Pointer Mechanism

In typical APIs, the stack-frame base pointer and the stack pointer point to the same location before a procedure call (the top-of-stack of the prior stack frame). After data is pushed onto the stack, the stack-frame base pointer remains where it was and the stack pointer advances downward to the address below the pushed data, where it becomes the new top-of-stack.

In legacy and compatibility modes, the default stack pointer size is 16 bits (SP) or 32 bits (ESP), depending on the default-size (B) bit in the stack-segment descriptor, and multiple stacks can be maintained in separate stack segments. In 64-bit mode, stack pointers are always 64 bits wide (RSP).

Further application-programming details on the stack mechanism are described in “Control Transfers” on page 94. System-programming details on the stack segments are described in “Segmented Virtual Memory” in Volume 2.

2.5 Instruction Pointer

The instruction pointer is used in conjunction with the code-segment (CS) register to locate the next instruction in memory. The instruction-pointer register contains the displacement (offset)—from the base address of the current CS segment, or from address 0 in 64-bit mode—to the next instruction to be executed. The pointer is incremented sequentially, except for branch instructions, as described in “Control Transfers” on page 94.

In legacy and compatibility modes, the instruction pointer is a 16-bit (IP) or 32-bit (EIP) register. In 64-bit mode, the instruction pointer is extended to a 64-bit (RIP) register to support 64-bit offsets. The case-sensitive acronym, *rIP*, is used to refer to any of these three instruction-pointer sizes, depending on the software context.

Figure 2-10 shows the relationship between RIP, EIP, and IP. The 64-bit RIP can be used for RIP-relative addressing, as described in “RIP-Relative Addressing” on page 22.

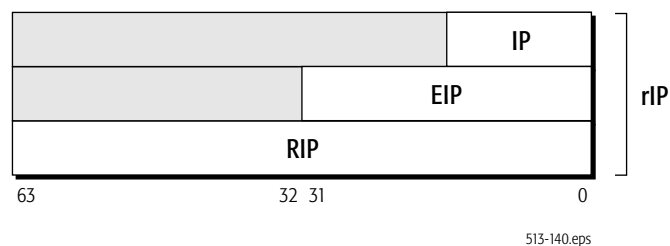

Figure 2-10. Instruction Pointer (rIP) Register

The contents of the rIP are not directly readable by software. However, the rIP is pushed onto the stack by a call instruction.

The memory model described in this chapter is used by all of the programming environments that make up the AMD64 architecture. The next four chapters of this volume describe the application programming environments, which include:

- General-purpose programming (Chapter 3 on page 27).
- 128-bit media programming (Chapter 4 on page 131).
- 64-bit media programming (Chapter 5 on page 237).
- x87 floating-point programming (Chapter 6 on page 293).

3 General-Purpose Programming

The general-purpose programming model includes the general-purpose registers (GPRs), integer instructions and operands that use the GPRs, program-flow control methods, memory optimization methods, and I/O. This programming model includes the original x86 integer-programming architecture, plus 64-bit extensions and a few additional instructions. Only the application-programming instructions and resources are described in this chapter. Integer instructions typically used in system programming, including all of the privileged instructions, are described in Volume 2, along with other system-programming topics.

The general-purpose programming model is used to some extent by almost all programs, including programs consisting primarily of 128-bit media instructions, 64-bit media instructions, x87 floating-point instructions, or system instructions. For this reason, an understanding of the general-purpose programming model is essential for any programming work using the AMD64 instruction set architecture.

3.1 Registers

Figure 3-1 on page 28 shows an overview of the registers used in general-purpose application programming. They include the general-purpose registers (GPRs), segment registers, flags register, and instruction-pointer register. The number and width of available registers depends on the operating mode.

The registers and register ranges shaded *light gray* in Figure 3-1 are available only in 64-bit mode. Those shaded *dark gray* are available only in legacy mode and compatibility mode. Thus, in 64-bit mode, the 32-bit general-purpose, flags, and instruction-pointer registers available in legacy mode and compatibility mode are extended to 64-bit widths, eight new GPRs are available, and the DS, ES, and SS segment registers are ignored.

When naming registers, if reference is made to multiple register widths, a lower-case *r* notation is used. For example, the notation *rAX* refers to the 16-bit AX, 32-bit EAX, or 64-bit RAX register, depending on an instruction's effective operand size.

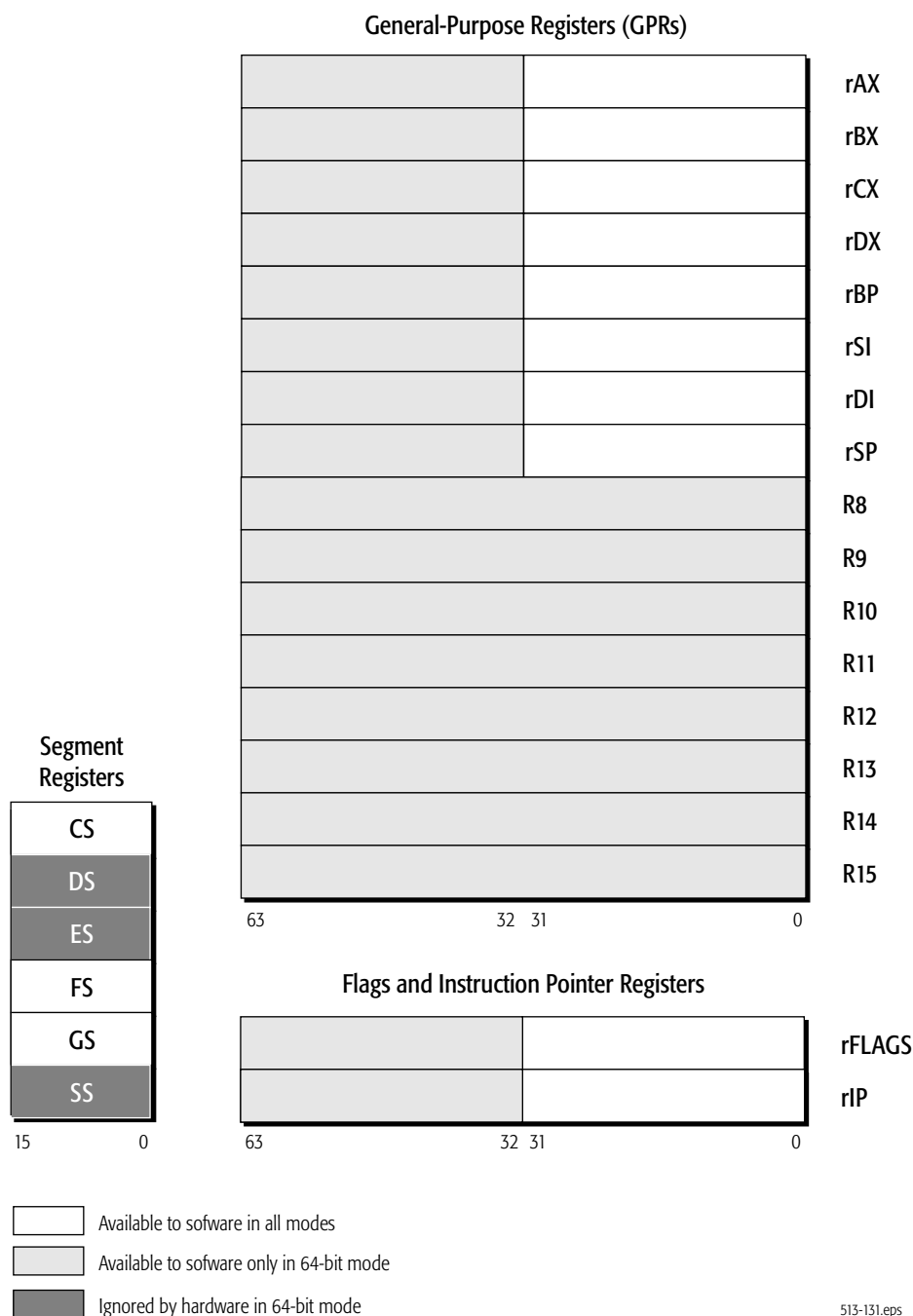

Figure 3-1. General-Purpose Programming Registers

3.1.1 Legacy Registers In legacy and compatibility modes, all of the legacy x86 registers are available. Figure 3-2 shows a detailed view of the GPR, flag, and instruction-pointer registers.

register encoding	high 8-bit	low 8-bit	16-bit	32-bit				
0	AH (4)	AL	AX	EAX				
3	BH (7)	BL	BX	EBX				
1	CH (5)	CL	CX	ECX				
2	DH (6)	DL	DX	EDX				
6	SI		SI	ESI				
7	DI		DI	EDI				
5	BP		BP	EBP				
4	SP		SP	ESP				
	31	16 15						
	<table border="1"> <tr> <td></td> <td>FLAGS</td> </tr> <tr> <td></td> <td>IP</td> </tr> </table>			FLAGS		IP	FLAGS	EFLAGS
	FLAGS							
	IP							
	31	0	IP	EIP				

513-311.eps

Figure 3-2. General Registers in Legacy and Compatibility Modes

The legacy GPRs include:

- Eight 8-bit registers (AH, AL, BH, BL, CH, CL, DH, DL).
- Eight 16-bit registers (AX, BX, CX, DX, DI, SI, BP, SP).
- Eight 32-bit registers (EAX, EBX, ECX, EDX, EDI, ESI, EBP, ESP).

The size of register used by an instruction depends on the effective operand size or, for certain instructions, the opcode, address size, or stack size. The 16-bit and 32-bit registers are encoded as 0 through 7 in Figure 3-2. For opcodes that specify a byte operand, registers encoded as 0 through 3 refer to the low-byte registers (AL, BL, CL, DL) and registers encoded as 4 through 7 refer to the high-byte registers (AH, BH, CH, DH).

The 16-bit FLAGS register, which is also the low 16 bits of the 32-bit EFLAGS register, shown in Figure 3-2, contains control and status bits accessible to application software, as described in Section 3.1.4, “Flags Register,” on page 38. The 16-bit IP or

32-bit EIP instruction-pointer register contains the address of the next instruction to be executed, as described in Section 2.5, “Instruction Pointer,” on page 24.

3.1.2 64-Bit-Mode Registers

In 64-bit mode, eight new GPRs are added to the eight legacy GPRs, all 16 GPRs are 64 bits wide, and the low bytes of all registers are accessible. Figure 3-3 on page 31 shows the GPRs, flags register, and instruction-pointer register available in 64-bit mode. The GPRs include:

- Sixteen 8-bit low-byte registers (AL, BL, CL, DL, SIL, DIL, BPL, SPL, R8B, R9B, R10B, R11B, R12B, R13B, R14B, R15B).
- Four 8-bit high-byte registers (AH, BH, CH, DH), addressable only when no REX prefix is used.
- Sixteen 16-bit registers (AX, BX, CX, DX, DI, SI, BP, SP, R8W, R9W, R10W, R11W, R12W, R13W, R14W, R15W).
- Sixteen 32-bit registers (EAX, EBX, ECX, EDX, EDI, ESI, EBP, ESP, R8D, R9D, R10D, R11D, R12D, R13D, R14D, R15D).
- Sixteen 64-bit registers (RAX, RBX, RCX, RDX, RDI, RSI, RBP, RSP, R8, R9, R10, R11, R12, R13, R14, R15).

The size of register used by an instruction depends on the effective operand size or, for certain instructions, the opcode, address size, or stack size. For most instructions, access to the extended GPRs requires a REX prefix (Section 3.5.2, “REX Prefixes,” on page 91). The four high-byte registers (AH, BH, CH, DH) available in legacy mode are not addressable when a REX prefix is used.

In general, byte and word operands are stored in the low 8 or 16 bits of GPRs without modifying their high 56 or 48 bits, respectively. Doubleword operands, however, are normally stored in the low 32 bits of GPRs and zero-extended to 64 bits.

The 64-bit RFLAGS register, shown in Figure 3-3 on page 31, contains the legacy EFLAGS in its low 32-bit range. The high 32 bits are reserved. They can be written with anything but they always read as zero (RAZ). The 64-bit RIP instruction-pointer register contains the address of the next instruction to be executed, as described in Section 3.1.5, “Instruction Pointer Register,” on page 42.

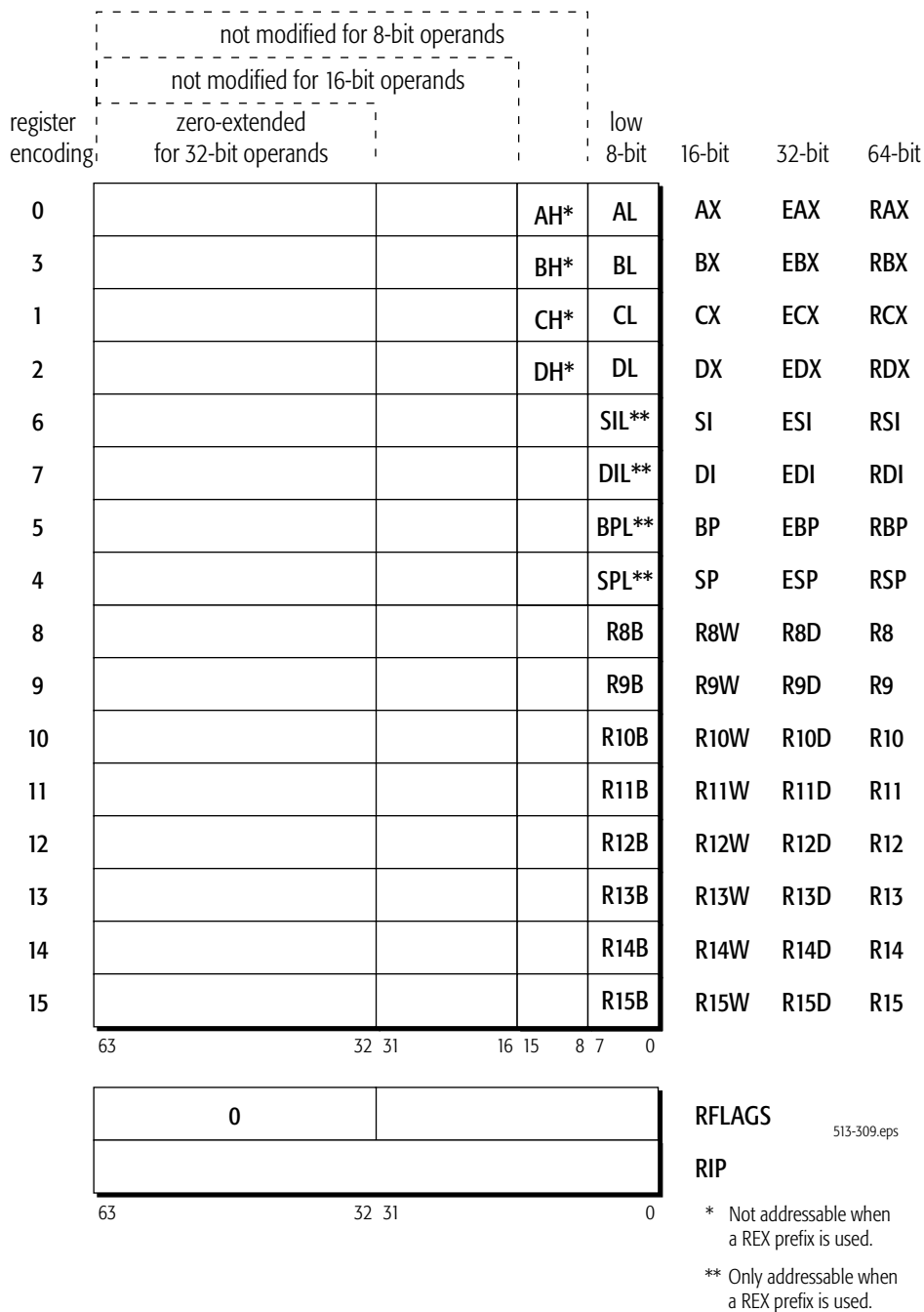

Figure 3-3. General Registers in 64-Bit Mode

Figure 3-4 on page 32 illustrates another way of viewing the 64-bit-mode GPRs, showing how the legacy GPRs overlap the extended GPRs. Gray-shaded bits are not modified in 64-bit mode.

	63	32	31	16	15	8	7	0
0	Gray areas are not modified in 64-bit mode.					AH*	AL	
						AX		
	0					EAX		
	RAX							
3	Gray areas are not modified in 64-bit mode.					BH*	BL	
						BX		
	0					EBX		
	RBX							
1	Gray areas are not modified in 64-bit mode.					CH*	CL	
						CX		
	0					ECX		
	RCX							
2	Gray areas are not modified in 64-bit mode.					DH*	DL	
						DX		
	0					EDX		
	RDX							
6	Gray areas are not modified in 64-bit mode.							SIL**
								SI
	0							ESI
	RSI							
7	Gray areas are not modified in 64-bit mode.							DIL**
								DI
	0							EDI
	RDI							
5	Gray areas are not modified in 64-bit mode.							BPL**
								BP
	0							EBP
	RBP							
4	Gray areas are not modified in 64-bit mode.							SPL**
								SP
	0							ESP
	RSP							
8	Gray areas are not modified in 64-bit mode.							R8B
								R8W
	0							R8D
	R8							
⋮								
15	Gray areas are not modified in 64-bit mode.							R15B
								R15W
	0							R15D
	R15							

* Not addressable when a REX prefix is used.

** Only addressable when a REX prefix is used.

Figure 3-4. GPRs in 64-Bit Mode

Default Operand Size. For most instructions, the default operand size in 64-bit mode is 32 bits. To access 16-bit operand sizes, an instruction must contain an operand-size prefix (66h), as described in Section 3.2.2, “Operand Sizes and Overrides,” on page 45. To access the full 64-bit operand size, most instructions must contain a REX prefix.

For details on operand size, see Section 3.2.2, “Operand Sizes and Overrides,” on page 45.

Byte Registers. 64-bit mode provides a uniform set of low-byte, low-word, low-doubleword, and quadword registers that is well-suited for register allocation by compilers. Access to the four new low-byte registers in the legacy-GPR range (SIL, DIL, BPL, SPL), or any of the low-byte registers in the extended registers (R8B–R15B), requires a REX instruction prefix. However, the legacy high-byte registers (AH, BH, CH, DH) are not accessible when a REX prefix is used.

Zero-Extension of 32-Bit Results. As Figure 3-3 and Figure 3-4 show, when performing 32-bit operations with a GPR destination in 64-bit mode, the processor zero-extends the 32-bit result into the full 64-bit destination. 8-bit and 16-bit operations on GPRs preserve all unwritten upper bits of the destination GPR. This is consistent with legacy 16-bit and 32-bit semantics for partial-width results.

Software should explicitly sign-extend the results of 8-bit, 16-bit, and 32-bit operations to the full 64-bit width before using the results in 64-bit address calculations.

The following four code examples show how 64-bit, 32-bit, 16-bit, and 8-bit ADDs work. In these examples, “48” is a REX prefix specifying 64-bit operand size, and “01C3” and “00C3” are the opcode and ModRM bytes of each instruction (see “Opcode Syntax” in Volume 3 for details on the opcode and ModRM encoding).

Example 1: 64-bit Add:

```
Before:RAX =0002_0001_8000_2201
        RBX =0002_0002_0123_3301
```

```
48 01C3 ADD RBX,RAX ;48 is a REX prefix for size.
```

```
Result:RBX = 0004_0003_8123_5502
```

Example 2: 32-bit Add:

```
Before:RAX = 0002_0001_8000_2201
        RBX = 0002_0002_0123_3301

        01C3 ADD EBX,EAX ;32-bit add

Result:RBX = 0000_0000_8123_5502
        (32-bit result is zero extended)
```

Example 3: 16-bit Add:

```
Before:RAX = 0002_0001_8000_2201
        RBX = 0002_0002_0123_3301

        66 01C3 ADD BX,AX ;66 is 16-bit size override

Result:RBX = 0002_0002_0123_5502
        (bits 63:16 are preserved)
```

Example 4: 8-bit Add:

```
Before:RAX = 0002_0001_8000_2201
        RBX = 0002_0002_0123_3301

        00C3 ADD BL,AL ;8-bit add

Result:RBX = 0002_0002_0123_3302
        (bits 63:08 are preserved)
```

GPR High 32 Bits Across Mode Switches. The processor does not preserve the upper 32 bits of the 64-bit GPRs across switches from 64-bit mode to compatibility or legacy modes. When using 32-bit operands in compatibility or legacy mode, the high 32 bits of GPRs are undefined. Software must not rely on these undefined bits, because they can change from one implementation to the next or even on a cycle-to-cycle basis within a given implementation. The undefined bits are not a function of the data left by any previously running process.

3.1.3 Implicit Uses of GPRs

Most instructions can use any of the GPRs for operands. However, as Table 3-1 shows, some instructions use some GPRs implicitly. Details about implicit use of GPRs are described in “General-Purpose Instruction Reference” in Volume 3.

Table 3-1 on page 35 shows implicit register uses only for application instructions. Certain system instructions also make implicit use of registers. These system instructions are described in “System Instruction Reference” in Volume 3.

Table 3-1. Implicit Uses of GPRs

Registers ¹				Name	Implicit Uses
Low 8-Bit	16-Bit	32-Bit	64-Bit		
AL	AX	EAX	RAX ²	Accumulator	<ul style="list-style-type: none"> • Operand for decimal arithmetic, multiply, divide, string, compare-and-exchange, table-translation, and I/O instructions. • Special accumulator encoding for ADD, XOR, and MOV instructions. • Used with EDX to hold double-precision operands. • CPUID processor-feature information.
BL	BX	EBX	RBX ²	Base	<ul style="list-style-type: none"> • Address generation in 16-bit code. • Memory address for XLAT instruction. • CPUID processor-feature information.
CL	CX	ECX	RCX ²	Count	<ul style="list-style-type: none"> • Bit index for shift and rotate instructions. • Iteration count for loop and repeated string instructions. • Jump conditional if zero. • CPUID processor-feature information.
DL	DX	EDX	RDX ²	I/O Address	<ul style="list-style-type: none"> • Operand for multiply and divide instructions. • Port number for I/O instructions. • Used with EAX to hold double-precision operands. • CPUID processor-feature information.

Note:

1. Gray-shaded registers have no implicit uses.
2. Accessible only in 64-bit mode.

Table 3-1. Implicit Uses of GPRs (continued)

Registers ¹				Name	Implicit Uses
Low 8-Bit	16-Bit	32-Bit	64-Bit		
SIL ²	SI	ESI	RSI ²	Source Index	<ul style="list-style-type: none"> Memory address of source operand for string instructions. Memory index for 16-bit addresses.
DIL ²	DI	EDI	RDI ²	Destination Index	<ul style="list-style-type: none"> Memory address of destination operand for string instructions. Memory index for 16-bit addresses.
BPL ²	BP	EBP	RBP ²	Base Pointer	<ul style="list-style-type: none"> Memory address of stack-frame base pointer.
SPL ²	SP	ESP	RSP ²	Stack Pointer	<ul style="list-style-type: none"> Memory address of last stack entry (top of stack).
R8B–R10B ²	R8W–R10W ²	R8D–R10D ²	R8–R10 ²	None	No implicit uses
R11B ²	R11W ²	R11D ²	R11 ²	None	<ul style="list-style-type: none"> Holds the value of RFLAGS on SYSCALL/SYSRET.
R12B–R15B ²	R12W–R15W ²	R12D–R15D ²	R12–R15 ²	None	No implicit uses

Note:

- Gray-shaded registers have no implicit uses.
- Accessible only in 64-bit mode.

Arithmetic Operations. Several forms of the add, subtract, multiply, and divide instructions use AL or rAX implicitly. The multiply and divide instructions also use the concatenation of rDX:rAX for double-sized results (multiplies) or quotient and remainder (divides).

Sign-Extensions. The instructions that double the size of operands by sign extension (for example, CBW, CWDE, CDQE, CWD, CDQ, CQO) use rAX register implicitly for the operand. The CWD, CDQ, and CQO instructions also uses the rDX register.

Special MOVs. The MOV instruction has several opcodes that implicitly use the AL or rAX register for one operand.

String Operations. Many types of string instructions use the accumulators implicitly. Load string, store string, and scan

string instructions use AL or rAX for data and rDI or rSI for the offset of a memory address.

I/O-Address-Space Operations. The I/O and string I/O instructions use rAX to hold data that is received from or sent to a device located in the I/O-address space. DX holds the device I/O-address (the port number).

Table Translations. The table translate instruction (XLATB) uses AL for an memory index and rBX for memory base address.

Compares and Exchanges. Compare and exchange instructions (CMPXCHG) use the AL or rAX register for one operand.

Decimal Arithmetic. The decimal arithmetic instructions (AAA, AAD, AAM, AAS, DAA, DAS) that adjust binary-coded decimal (BCD) operands implicitly use the AL and AH register for their operations.

Shifts and Rotates. Shift and rotate instructions can use the CL register to specify the number of bits an operand is to be shifted or rotated.

Conditional Jumps. Special conditional-jump instructions use the rCX register instead of flags. The JCXZ and JrcXZ instructions check the value of the rCX register and pass control to the target instruction when the value of rCX register reaches 0.

Repeated String Operations. With the exception of I/O string instructions, all string operations use rSI as the source-operand pointer and rDI as the destination-operand pointer. I/O string instructions use rDX to specify the input-port or output-port number. For repeated string operations (those preceded with a repeat-instruction prefix), the rSI and rDI registers are incremented or decremented as the string elements are moved from the source location to the destination. Repeat-string operations also use rCX to hold the string length, and decrement it as data is moved from one location to the other.

Stack Operations. Stack operations make implicit use of the rSP register, and in some cases, the rBP register. The rSP register is used to hold the top-of-stack pointer (or simply, stack pointer). rSP is decremented when items are pushed onto the stack, and incremented when they are popped off the stack. The ENTER and LEAVE instructions use rBP as a stack-frame base pointer.

Here, `rBP` points to the last entry in a data structure that is passed from one block-structured procedure to another.

The use of `rSP` or `rBP` as a base register in an address calculation implies the use of `SS` (stack segment) as the default segment. Using any other GPR as a base register without a segment-override prefix implies the use of the `DS` data segment as the default segment.

The push all and pop all instructions (`PUSHA`, `PUSHAD`, `POPA`, `POPAD`) implicitly use all of the GPRs.

CPUID Information. The `CPUID` instruction makes implicit use of the `EAX`, `EBX`, `ECX`, and `EDX` registers. Software loads a function code into `EAX`, executes the `CPUID` instruction, and then reads the associated processor-feature information in `EAX`, `EBX`, `ECX`, and `EDX`.

3.1.4 Flags Register

Figure 3-5 on page 39 shows the 64-bit `RFLAGS` register and the flag bits visible to application software. Bits 15–0 are the `FLAGS` register (accessed in legacy real and virtual-8086 modes), bits 31–0 are the `EFLAGS` register (accessed in legacy protected mode and compatibility mode), and bits 63–0 are the `RFLAGS` register (accessed in 64-bit mode). The name *rFLAGS* refers to any of the three register widths, depending on the current software context.

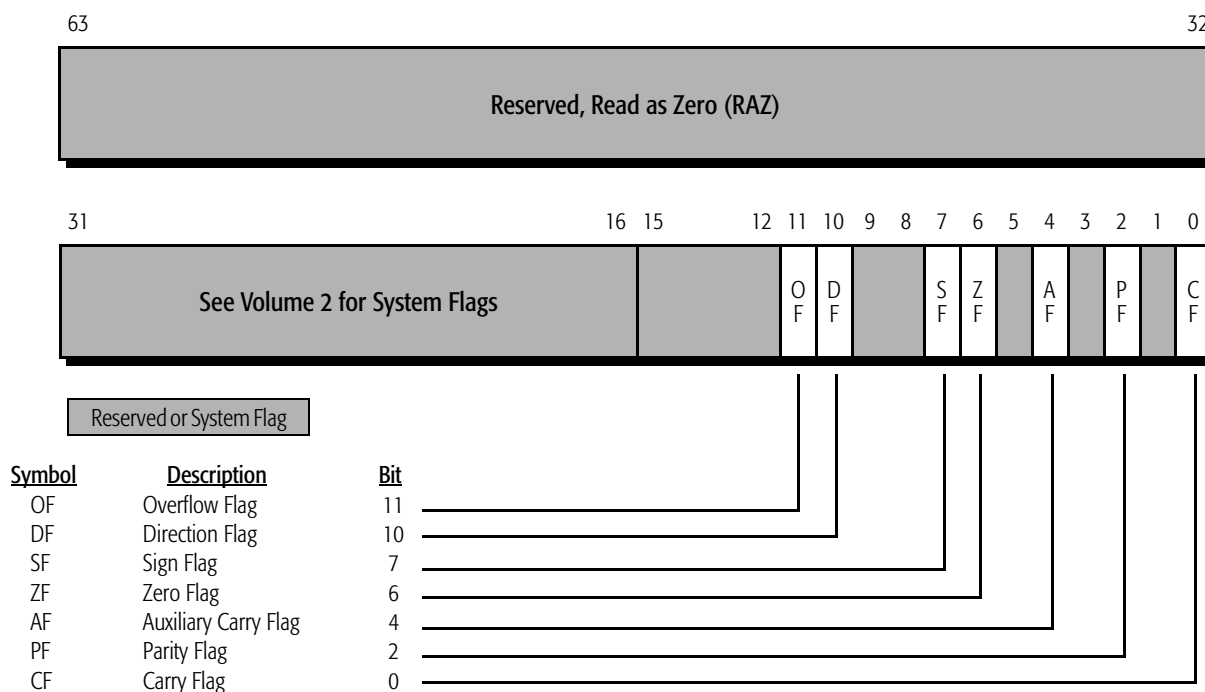

Figure 3-5. rFLAGS Register—Flags Visible to Application Software

The low 16 bits (FLAGS portion) of rFLAGS are accessible by application software and hold the following flags:

- One control flag (the direction flag DF).
- Six status flags (carry flag CF, parity flag PF, auxiliary carry flag AF, zero flag ZF, sign flag SF, and overflow flag OF).

The direction flag (DF) flag controls the direction of string operations. The status flags provide result information from logical and arithmetic operations and control information for conditional move and jump instructions.

Bits 31–16 of the rFLAGS register contain flags that are accessible only to system software. These flags are described in “System Registers” in Volume 2. The highest 32 bits of RFLAGS are reserved. In 64-bit mode, writes to these bits are ignored. They are read as zeros (RAZ). The rFLAGS register is initialized to 02h on reset, so that all of the programmable bits are cleared to zero.

The effects that rFLAGS bit-values have on instructions are summarized in the following places:

- Conditional Moves (CMOVcc)—Table 3-4 on page 52.
- Conditional Jumps (Jcc)—Table 3-5 on page 67.
- Conditional Sets (SETcc)—Table 3-6 on page 72.

The effects that instructions have on rFLAGS bit-values are summarized in “Instruction Effects on RFLAGS” in Volume 3.

The sections below describe each application-visible flag. All of these flags are readable and writable. For example, the POPF, POPFD, POPFQ, IRET, IRETD, and IRETQ instructions write all flags. The carry and direction flags are writable by dedicated application instructions. Other application-visible flags are written indirectly by specific instructions. Reserved bits and bits whose writability is prevented by the current values of system flags, current privilege level (CPL), or the current operating mode, are unaffected by the POPFx instructions.

Carry Flag (CF). Bit 0. Hardware sets the carry flag to 1 if the last integer addition or subtraction operation resulted in a carry (for addition) or a borrow (for subtraction) out of the most-significant bit position of the result. Otherwise, hardware clears the flag to 0.

The increment and decrement instructions—unlike the addition and subtraction instructions—do not affect the carry flag. The bit shift and bit rotate instructions shift bits of operands into the carry flag. Logical instructions like AND, OR, XOR clear the carry flag. Bit-test instructions (BTx) set the value of the carry flag depending on the value of the tested bit of the operand.

Software can set or clear the carry flag with the STC and CLC instructions, respectively. Software can complement the flag with the CMC instruction.

Parity Flag (PF). Bit 2. Hardware sets the parity flag to 1 if there is an even number of 1 bits in the least-significant byte of the last result of certain operations. Otherwise (i.e., for an odd number of 1 bits), hardware clears the flag to 0. Software can read the flag to implement parity checking.

Auxiliary Carry Flag (AF). Bit 4. Hardware sets the auxiliary carry flag to 1 if the last binary-coded decimal (BCD) operation

resulted in a carry (for addition) or a borrow (for subtraction) out of bit 3. Otherwise, hardware clears the flag to 0.

The main application of this flag is to support decimal arithmetic operations. Most commonly, this flag is used internally by correction commands for decimal addition (AAA) and subtraction (AAS).

Zero Flag (ZF). Bit 6. Hardware sets the zero flag to 1 if the last arithmetic operation resulted in a value of zero. Otherwise (for a non-zero result), hardware clears the flag to 0. The compare and test instructions also affect the zero flag.

The zero flag is typically used to test whether the result of an arithmetic or logical operation is zero, or to test whether two operands are equal.

Sign Flag (SF). Bit 7. Hardware sets the sign flag to 1 if the last arithmetic operation resulted in a negative value. Otherwise (for a positive-valued result), hardware clears the flag to 0. Thus, in such operations, the value of the sign flag is set equal to the value of the most-significant bit of the result. Depending on the size of operands, the most-significant bit is bit 7 (for bytes), bit 15 (for words), bit 31 (for doublewords), or bit 63 (for quadwords).

Direction Flag (DF). Bit 10. The direction flag determines the order in which strings are processed. Software can set the direction flag to 1 to specify decrementing the data pointer for the next string instruction (LODSx, STOSx, MOVSx, SCASx, CMPSx, OUTSx, or INSx). Clearing the direction flag to 0 specifies incrementing the data pointer. The pointers are stored in the rSI or rDI register. Software can set or clear the flag with the STD and CLD instructions, respectively.

Overflow Flag (OF). Bit 11. Hardware sets the overflow flag to 1 to indicate that the most-significant (sign) bit of the result of the last signed integer operation differed from the signs of both source operands. Otherwise, hardware clears the flag to 0. A set overflow flag means that the magnitude of the positive or negative result is too big (overflow) or too small (underflow) to fit its defined data type.

The OF flag is undefined after the DIV instruction and after a shift of more than one bit. Logical instructions clear the overflow flag.

3.1.5 **Instruction Pointer Register**

The instruction pointer register—IP, EIP, or RIP, or simply rIP for any of the three depending on the context—is used in conjunction with the code-segment (CS) register to locate the next instruction in memory. See Section 2.5, “Instruction Pointer,” on page 24 for details.

3.2 **Operands**

Operands are either referenced by an instruction's encoding or included as an immediate value in the instruction encoding. Depending on the instruction, referenced operands can be located in registers, memory locations, or I/O ports.

3.2.1 **Data Types**

Figure 3-6 on page 43 shows the register images of the general-purpose data types. In the general-purpose programming environment, these data types can be interpreted by instruction syntax or the software context as the following types of numbers and strings:

- Signed (two's-complement) integers.
- Unsigned integers.
- BCD digits.
- Packed BCD digits.
- Strings, including bit strings.

The double quadword data type is supported in the RDX:RAX registers by the MUL, IMUL, DIV, IDIV, and CQO instructions. Software can interpret the data types in ways other than those shown in Figure 3-6 on page 43 but the AMD64 instruction set does not directly support such interpretations and software must handle them entirely on its own.

Table 3-2 on page 44 shows the range of representable values for the general-purpose data types.

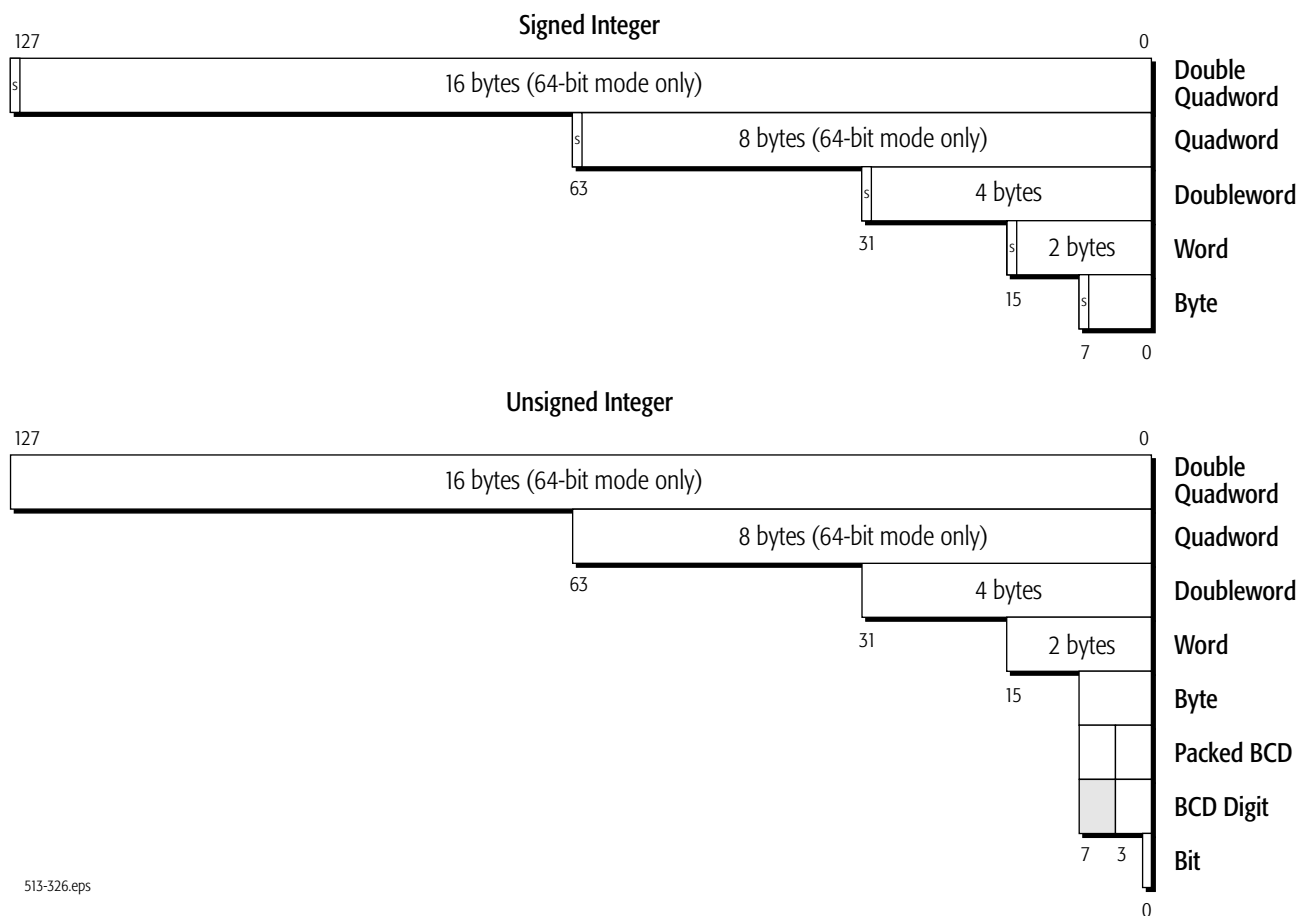

Figure 3-6. General-Purpose Data Types

Signed and Unsigned Integers. The architecture supports signed and unsigned 1 byte, 2 bytes, 4 byte and 8 byte integers. The sign bit is stored in the most significant bit.

Table 3-2. Representable Values of General-Purpose Data Types

Data Type	Byte	Word	Doubleword	Quadword	Double Quadword ²
Signed Integers¹	-2^7 to $+(2^7 - 1)$	-2^{15} to $+(2^{15} - 1)$	-2^{31} to $+(2^{31} - 1)$	-2^{63} to $+(2^{63} - 1)$	-2^{127} to $+(2^{127} - 1)$
Unsigned Integers	0 to $2^8 - 1$ (0 to 255)	0 to $2^{16} - 1$ (0 to 65,535)	0 to $2^{32} - 1$ (0 to 4.29×10^9)	0 to $2^{64} - 1$ (0 to 1.84×10^{19})	0 to $2^{128} - 1$ (0 to 3.40×10^{38})
Packed BCD Digits	00 to 99	multiple packed BCD-digit bytes			
BCD Digit	0 to 9	multiple BCD-digit bytes			
Note:					
1. The sign bit is the most-significant bit (e.g., bit 7 for a byte, bit 15 for a word, etc.).					
2. The double quadword data type is supported in the RDX:RAX registers by the MUL, IMUL, DIV, IDIV, and CQO instructions.					

Binary-Coded-Decimal (BCD) Digits. BCD digits have values ranging from 0 to 9. These values can be represented in binary encoding with four bits. For example, 0000b represents the decimal number 0 and 1001b represents the decimal number 9. Values ranging from 1010b to 1111b are invalid for this data type. Because a byte contains eight bits, two BCD digits can be stored in a single byte. This is referred to as *packed-BCD*. If a single BCD digit is stored per byte, it is referred to as *unpacked-BCD*. In the x87 floating-point programming environment (described in Section 6, “x87 Floating-Point Programming,” on page 293) an 80-bit packed BCD data type is also supported, along with conversions between floating-point and BCD data types, so that data expressed in the BCD format can be operated on as floating-point values.

Integer add, subtract, multiply, and divide instructions can be used to operate on single (unpacked) BCD digits. The result must be adjusted to produce a correct BCD representation. For unpacked BCD numbers, the ASCII-adjust instructions are provided to simplify that correction. In the case of division, the adjustment must be made prior to executing the integer-divide instruction.

Similarly, integer add and subtract instructions can be used to operate on packed-BCD digits. The result must be adjusted to produce a correct packed-BCD representation. Decimal-adjust

instructions are provided to simplify packed-BCD result corrections.

Strings. Strings are a continuous sequence of a single data type. The string instructions can be used to operate on byte, word, doubleword, or quadword data types. The maximum length of a string of any data type is $2^{32}-1$ bytes, in legacy or compatibility modes, or $2^{64}-1$ bytes in 64-bit mode. One of the more common types of strings used by applications are byte data-type strings known as ASCII strings, which can be used to represent character data.

Bit strings are also supported by instructions that operate specifically on bit strings. In general, bit strings can start and end at any bit location within any byte, although the BTx bit-string instructions assume that strings start on a byte boundary. The length of a bit string can range in size from a single bit up to $2^{32}-1$ bits, in legacy or compatibility modes, or $2^{64}-1$ bits in 64-bit mode.

3.2.2 Operand Sizes and Overrides

Default Operand Size. In legacy and compatibility modes, the default operand size is either 16 bits or 32 bits, as determined by the default-size (D) bit in the current code-segment descriptor (for details, see “Segmented Virtual Memory” in Volume 2). In 64-bit mode, the default operand size for most instructions is 32 bits.

Application software can override the default operand size by using an operand-size instruction prefix. Table 3-3 on page 46 shows the instruction prefixes for operand-size overrides in all operating modes. In 64-bit mode, the default operand size for most instructions is 32 bits. A REX prefix (see Section 3.5.2, “REX Prefixes,” on page 91) specifies a 64-bit operand size, and a 66h prefix specifies a 16-bit operand size. The REX prefix takes precedence over the 66h prefix.

Table 3-3. Operand-Size Overrides

Operating Mode		Default Operand Size (Bits)	Effective Operand Size (Bits)	Instruction Prefix	
				66h ¹	REX
Long Mode	64-Bit Mode	32 ²	64	x	yes
			32	no	no
			16	yes	no
	Compatibility Mode	32	32	no	Not Applicable
			16	yes	
		16	32	yes	
			16	no	
			32	no	
Legacy Mode (Protected, Virtual-8086, or Real Mode)	32	32	no		
		16	yes		
	16	32	yes		
		16	no		

Note:

1. A “no” indicates that the default operand size is used. An “x” means “don’t care.”
2. Near branches, instructions that implicitly reference the stack pointer, and certain other instructions default to 64-bit operand size. See “General-Purpose Instructions in 64-Bit Mode” in Volume 3

There are several exceptions to the 32-bit operand-size default in 64-bit mode, including near branches and instructions that implicitly reference the RSP stack pointer. For example, the near CALL, near JMP, Jcc, LOOPcc, POP, and PUSH instructions all default to a 64-bit operand size in 64-bit mode. Such instructions do not need a REX prefix for the 64-bit operand size. For details, see “General-Purpose Instructions in 64-Bit Mode” in Volume 3.

Effective Operand Size. The term *effective operand size* describes the operand size for the current instruction, after accounting for the instruction’s default operand size and any operand-size override or REX prefix that is used with the instruction.

Immediate Operand Size. In legacy mode and compatibility modes, the size of immediate operands can be 8, 16, or 32 bits, depending on the instruction. In 64-bit mode, the maximum size of an immediate operand is also 32 bits, except that 64-bit immediates can be copied into a 64-bit GPR using the MOV instruction.

When the operand size of a MOV instruction is 64 bits, the processor sign-extends immediates to 64 bits before using them. Support for true 64-bit immediates is accomplished by expanding the semantics of the MOV reg, imm16/32 instructions. In legacy and compatibility modes, these instructions—opcodes B8h through BFh—copy a 16-bit or 32-bit immediate (depending on the effective operand size) into a GPR. In 64-bit mode, if the operand size is 64 bits (requires a REX prefix), these instructions can be used to copy a true 64-bit immediate into a GPR.

3.2.3 Operand Addressing

Operands for general-purpose instructions are referenced by the instruction's syntax or they are incorporated in the instruction as an immediate value. Referenced operands can be in registers, memory, or I/O ports.

Register Operands. Most general-purpose instructions that take register operands reference the general-purpose registers (GPRs). A few general-purpose instructions reference operands in the RFLAGS register, XMM registers, or MMX™ registers.

The type of register addressed is specified in the instruction syntax. When addressing GPRs or XMM registers, the REX instruction prefix can be used to access the extended GPRs or XMM registers, as described in Section 3.5, “Instruction Prefixes,” on page 87.

Memory Operands. Many general-purpose instructions can access operands in memory. Section 2.2, “Memory Addressing,” on page 16 describes the general methods and conditions for addressing memory operands.

I/O Ports. Operands in I/O ports are referenced according to the conventions described in Section 3.8, “Input/Output,” on page 111.

Immediate Operands. In certain instructions, a source operand—called an *immediate operand*, or simply *immediate*—is included

as part of the instruction rather than being accessed from a register or memory location. For details on the size of immediate operands, see “Immediate Operand Size” on page 47.

3.2.4 Data Alignment

A data access is *aligned* if its address is a multiple of its operand size, in bytes. The following examples illustrate this definition:

- *Byte* accesses are always aligned. Bytes are the smallest addressable parts of memory.
- *Word* (two-byte) accesses are aligned if their address is a multiple of 2.
- *Doubleword* (four-byte) accesses are aligned if their address is a multiple of 4.
- *Quadword* (eight-byte) accesses are aligned if their address is a multiple of 8.

The AMD64 architecture does not impose data-alignment requirements for accessing data in memory. However, depending on the location of the misaligned operand with respect to the width of the data bus and other aspects of the hardware implementation (such as store-to-load forwarding mechanisms), a misaligned memory access can require more bus cycles than an aligned access. For maximum performance, avoid misaligned memory accesses.

Performance on many hardware implementations will benefit from observing the following operand-alignment and operand-size conventions:

- Avoid misaligned data accesses.
- Maintain consistent use of operand size across all loads and stores. Larger operand sizes (doubleword and quadword) tend to make more efficient use of the data bus and any data-forwarding features that are implemented by the hardware.
- When using word or byte stores, avoid loading data from the same doubleword of memory, other than the identical start addresses of the stores.

3.3 Instruction Summary

This section summarizes the functions of the general-purpose instructions. The instructions are organized by functional group—such as, data-transfer instructions, arithmetic instructions, and so on. Details on individual instructions are given in the alphabetically organized “General-Purpose Instruction Reference” in Volume 3.

3.3.1 Syntax

Each instruction has a *mnemonic syntax* used by assemblers to specify the operation and the operands to be used for source and destination (result) data. Figure 3-7 shows an example of the mnemonic syntax for a compare (CMP) instruction. In this example, the CMP mnemonic is followed by two operands, a 32-bit register or memory operand and an 8-bit immediate operand.

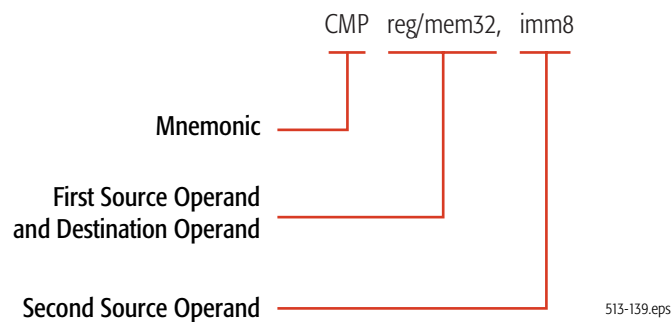

Figure 3-7. Mnemonic Syntax Example

In most instructions that take two operands, the first (left-most) operand is both a source operand and the destination operand. The second (right-most) operand serves only as a source. Instructions can have one or more prefixes that modify default instruction functions or operand properties. These prefixes are summarized in Section 3.5, “Instruction Prefixes,” on page 87. Instructions that access 64-bit operands in a general-purpose register (GPR) or any of the extended GPR or XMM registers require a REX instruction prefix.

Unless otherwise stated in this section, the word *register* means a general-purpose register (GPR). Several instructions affect the flag bits in the RFLAGS register. “Instruction Effects on

RFLAGS” in Volume 3 summarizes the effects that instructions have on rFLAGS bits.

3.3.2 Data Transfer

The data-transfer instructions copy data between registers and memory.

Move.

- MOV—Move
- MOVSX—Move with Sign-Extend
- MOVZX—Move with Zero-Extend
- MOVD—Move Doubleword or Quadword
- MOVNTI—Move Non-Temporal Doubleword or Quadword

MOV x copies a byte, word, doubleword, or quadword from a register or memory location to a register or memory location. The source and destination cannot both be memory locations. An immediate constant can be used as a source operand with the MOV instruction. For MOV, the destination must be of the same size as the source, but the MOVSX and MOVZX instructions copy values of smaller size to a larger size by using sign-extension or zero-extension. The MOVD instruction copies a doubleword or quadword between a general-purpose register or memory and an XMM or MMX register.

The MOV instruction is in many aspects similar to the assignment operator in high-level languages. The simplest example of their use is to initialize variables. To initialize a register to 0, rather than using a MOV instruction it may be more efficient to use the XOR instruction with identical destination and source operands.

The MOVNTI instruction stores a doubleword or quadword from a register into memory as “non-temporal” data, which assumes a single access (as opposed to frequent subsequent accesses of “temporal data”). The operation therefore minimizes cache pollution. The exact method by which cache pollution is minimized depends on the hardware implementation of the instruction. For further information, see Section 3.9, “Memory Optimization,” on page 115.

Conditional Move.

- CMOV cc —Conditional Move If *condition*

The `CMOVcc` instructions conditionally copy a word, doubleword, or quadword from a register or memory location to a register location. The source and destination must be of the same size.

The `CMOVcc` instructions perform the same task as `MOV` but work conditionally, depending on the state of status flags in the `RFLAGS` register. If the condition is not satisfied, the instruction has no effect and control is passed to the next instruction. The mnemonics of `CMOVcc` instructions indicate the condition that must be satisfied. Several mnemonics are often used for one opcode to make the mnemonics easier to remember. For example, `CMOVE` (conditional move if equal) and `CMOVZ` (conditional move if zero) are aliases and compile to the same opcode. Table 3-4 on page 52 shows the `RFLAGS` values required for each `CMOVcc` instruction.

In assembly languages, the conditional move instructions correspond to small conditional statements like:

```
IF a = b THEN x = y
```

`CMOVcc` instructions can replace two instructions—a conditional jump and a move. For example, to perform a high-level statement like:

```
IF ECX = 5 THEN EAX = EBX
```

without a `CMOVcc` instruction, the code would look like:

```
cmp ecx, 5          ; test if ecx equals 5
jnz Continue       ; test condition and skip if not met
mov eax, ebx        ; move
Continue:           ; continuation
```

but with a `CMOVcc` instruction, the code would look like:

```
cmp ecx, 5          ; test if ecx equals to 5
cmovz eax, ebx      ; test condition and move
```

Replacing conditional jumps with conditional moves also has the advantage that it can avoid branch-prediction penalties that may be caused by conditional jumps.

Support for `CMOVcc` instructions depends on the processor implementation. To find out if a processor is able to perform `CMOVcc` instructions, use the `CPUID` instruction.

Table 3-4. rFLAGS for CMOVcc Instructions

Mnemonic	Required Flag State	Description
CMOVO	OF = 1	Conditional move if overflow
CMOVNO	OF = 0	Conditional move if not overflow
CMOVB CMOVC CMOVNAE	CF = 1	Conditional move if below Conditional move if carry Conditional move if not above or equal
CMOVAE CMOVNB CMOVNC	CF = 0	Conditional move if above or equal Conditional move if not below Conditional move if not carry
CMOVE CMOVZ	ZF = 1	Conditional move if equal Conditional move if zero
CMOVNE CMOVNZ	ZF = 0	Conditional move if not equal Conditional move if not zero
CMOVBE CMOVNA	CF = 1 or ZF = 1	Conditional move if below or equal Conditional move if not above
CMOVA CMOVNBE	CF = 0 and ZF = 0	Conditional move if not below or equal Conditional move if not below or equal
CMOVS	SF = 1	Conditional move if sign
CMOVNS	SF = 0	Conditional move if not sign
CMOVP CMOVPE	PF = 1	Conditional move if parity Conditional move if parity even
CMOVNP CMOVPO	PF = 0	Conditional move if not parity Conditional move if parity odd
CMOVL CMOVNGE	SF \diamond OF	Conditional move if less Conditional move if not greater or equal
CMOVGE CMOVNL	SF = OF	Conditional move if greater or equal Conditional move if not less
CMOVLE CMOVNG	ZF = 1 or SF \diamond OF	Conditional move if less or equal Conditional move if not greater
CMOVG CMOVNLE	ZF = 0 and SF = OF	Conditional move if greater Conditional move if not less or equal

Stack Operations.

- POP—Pop Stack
- POPA—Pop All to GPR Words
- POPAD—Pop All to GPR Doublewords
- PUSH—Push onto Stack
- PUSHA—Push All GPR Words onto Stack
- PUSHAD—Push All GPR Doublewords onto Stack
- ENTER—Create Procedure Stack Frame
- LEAVE—Delete Procedure Stack Frame

PUSH copies the specified register, memory location, or immediate value to the top of stack. This instruction decrements the stack pointer by 2, 4, or 8, depending on the operand size, and then copies the operand into the memory location pointed to by SS:rSP.

POP copies a word, doubleword, or quadword from the memory location pointed to by the SS:rSP registers (the top of stack) to a specified register or memory location. Then, the rSP register is incremented by 2, 4, or 8. After the POP operation, rSP points to the new top of stack.

PUSHA or PUSHAD stores eight word-sized or doubleword-sized registers onto the stack: eAX, eCX, eDX, eBX, eSP, eBP, eSI and eDI, in that order. The stored value of eSP is sampled at the moment when the PUSHA instruction started. The resulting stack-pointer value is decremented by 16 or 32.

POPA or POPAD extracts eight word-sized or doubleword-sized registers from the stack: eDI, eSI, eBP, eSP, eBX, eDX, eCX and eAX, in that order (which is the reverse of the order used in the PUSHA instruction). The stored eSP value is ignored by the POPA instruction. The resulting stack pointer value is incremented by 16 or 32.

It is a common practice to use PUSH instructions to pass parameters (via the stack) to functions and subroutines. The typical instruction sequence used at the beginning of a subroutine looks like:

```
push  ebp           ; save current EBP
mov   ebp, esp     ; set stack frame pointer value
sub   esp, N       ; allocate space for local variables
```

The rBP register is used as a *stack frame pointer*—a base address of the stack area used for parameters passed to subroutines and local variables. Positive offsets of the stack frame pointed to by rBP provide access to parameters passed while negative offsets give access to local variables. This technique allows creating re-entrant subroutines.

The ENTER and LEAVE instructions provide support for procedure calls, and are mainly used in high-level languages. The ENTER instruction is typically the first instruction of the procedure, and the LEAVE instruction is the last before the RET instruction.

The ENTER instruction creates a stack frame for a procedure. The first operand, *size*, specifies the number of bytes allocated in the stack. The second operand, *depth*, specifies the number of stack-frame pointers copied from the calling procedure's stack (i.e., the nesting level). The depth should be an integer in the range 0–31.

Typically, when a procedure is called, the stack contains the following four components:

- Parameters passed to the called procedure (created by the calling procedure).
- Return address (created by the CALL instruction).
- Array of stack-frame pointers (pointers to stack frames of procedures with smaller nesting-level depth) which are used to access the local variables of such procedures.
- Local variables used by the called procedure.

All these data are called the *stack frame*. The ENTER instruction simplifies management of the last two components of a stack frame. First, the current value of the rBP register is pushed onto the stack. The value of the rSP register at that moment is a *frame pointer* for the current procedure: positive offsets from this pointer give access to the parameters passed to the procedure, and negative offsets give access to the local variables which will be allocated later. During procedure execution, the value of the frame pointer is stored in the rBP register, which at that moment contains a frame pointer of the calling procedure. This frame pointer is saved in a temporary register. If the depth operand is greater than one, the array of *depth-1* frame pointers of procedures with smaller nesting level is pushed onto the stack. This array is copied from the stack

frame of the calling procedure, and it is addressed by the rBP register from the calling procedure. If the depth operand is greater than zero, the saved frame pointer of the current procedure is pushed onto the stack (forming an array of *depth* frame pointers). Finally, the saved value of the frame pointer is copied to the rBP register, and the rSP register is decremented by the value of the first operand, allocating space for local variables used in the procedure. See “Stack Operations” on page 53 for a parameter-passing instruction sequence using PUSH that is equivalent to ENTER.

The LEAVE instruction removes local variables and the array of frame pointers, allocated by the previous ENTER instruction, from the stack frame. This is accomplished by the following two steps: first, the value of the frame pointer is copied from the rBP register to the rSP register. This releases the space allocated by local variables and an array of frame pointers of procedures with smaller nesting levels. Second, the rBP register is popped from the stack, restoring the previous value of the frame pointer (or simply the value of the rBP register, if the depth operand is zero). Thus, the LEAVE instruction is equivalent to the following code:

```
mov rSP, rBP
pop rBP
```

3.3.3 Data Conversion

The data-conversion instructions perform various transformations of data, such as operand-size doubling by sign extension, conversion of little-endian to big-endian format, extraction of sign masks, searching a table, and support for operations with decimal numbers.

Sign Extension.

- CBW—Convert Byte to Word
- CWDE—Convert Word to Doubleword
- CDQE—Convert Doubleword to Quadword
- CWD—Convert Word to Doubleword
- CDQ—Convert Doubleword to Quadword
- CQO—Convert Quadword to Octword

The CBW, CWDE, and CDQE instructions sign-extend the AL, AX, or EAX register to the upper half of the AX, EAX, or RAX register, respectively. By doing so, these instructions create a double-sized destination operand in rAX that has the same

numerical value as the source operand. The CBW, CWDE, and CDQE instructions have the same opcode, and the action taken depends on the effective operand size.

The CWD, CDQ and CQO instructions sign-extend the AX, EAX, or RAX register to all bit positions of the DX, EDX, or RDX register, respectively. By doing so, these instructions create a double-sized destination operand in rDX:rAX that has the same numerical value as the source operand. The CWD, CDQ, and CQO instructions have the same opcode, and the action taken depends on the effective operand size.

Flags are not affected by these instructions. The instructions can be used to prepare an operand for signed division (performed by the IDIV instruction) by doubling its storage size.

Extract Sign Mask.

- MOVMSKPS—Extract Packed Single-Precision Floating-Point Sign Mask
- MOVMSKPD—Extract Packed Double-Precision Floating-Point Sign Mask

The MOVMSKPS instruction moves the sign bits of four packed single-precision floating-point values in an XMM register to the four low-order bits of a general-purpose register, with zero-extension. MOVMSKPD does a similar operation for two packed double-precision floating-point values: it moves the two sign bits to the two low-order bits of a general-purpose register, with zero-extension. The result of either instruction is a sign-bit mask.

Translate.

- XLAT—Translate Table Index

The XLAT instruction replaces the value stored in the AL register with a table element. The initial value in AL serves as an unsigned index into the table, and the start (base) of table is specified by the DS:rBX registers (depending on the effective address size).

This instruction is not recommended. The following instruction serves to replace it:

```
MOV AL,[rBX + AL]
```

ASCII Adjust.

- AAA—ASCII Adjust After Addition
- AAD—ASCII Adjust Before Division
- AAM—ASCII Adjust After Multiply
- AAS—ASCII Adjust After Subtraction

The AAA, AAD, AAM, and AAS instructions perform corrections of arithmetic operations with non-packed BCD values (i.e., when the decimal digit is stored in a byte register). There are no instructions which directly operate on decimal numbers (either packed or non-packed BCD). However, the ASCII-adjust instructions correct decimal-arithmetic results. These instructions assume that an arithmetic instruction, such as ADD, was performed on two BCD operands, and that the result was stored in the AL or AX register. This result can be incorrect or it can be a non-BCD value (for example, when a decimal carry occurs). After executing the proper ASCII-adjust instruction, the AX register contains a correct BCD representation of the result. (The AAD instruction is an exception to this, because it should be applied *before* a DIV instruction, as explained below). All of the ASCII-adjust instructions are able to operate with multiple-precision decimal values.

AAA should be applied after addition of two non-packed decimal digits. AAS should be applied after subtraction of two non-packed decimal digits. AAM should be applied after multiplication of two non-packed decimal digits. AAD should be applied *before* the division of two non-packed decimal numbers.

Although the base of the numeration for ASCII-adjust instructions is assumed to be 10, the AAM and AAD instructions can be used to correct multiplication and division with other bases.

BCD Adjust.

- DAA—Decimal Adjust after Addition
- DAS—Decimal Adjust after Subtraction

The DAA and DAS instructions perform corrections of addition and subtraction operations on packed BCD values. (Packed BCD values have two decimal digits stored in a byte register, with the higher digit in the higher four bits, and the lower one in the

lower four bits.) There are no instructions for correction of multiplication and division with packed BCD values.

DAA should be applied after addition of two packed-BCD numbers. DAS should be applied after subtraction of two packed-BCD numbers.

DAA and DAS can be used in a loop to perform addition or subtraction of two multiple-precision decimal numbers stored in packed-BCD format. Each loop cycle would operate on corresponding bytes (containing two decimal digits) of operands.

Endian Conversion.

- BSWAP—Byte Swap

The BSWAP instruction changes the byte order of a doubleword or quadword operand in a register, as shown in Figure 3-8. In a doubleword, bits 7–0 are exchanged with bits 31–24, and bits 15–8 are exchanged with bits 23–16. In a quadword, bits 7–0 are exchanged with bits 63–56, bits 15–8 with bits 55–48, bits 23–16 with bits 47–40, and bits 31–24 with bits 39–32. See the following illustration.

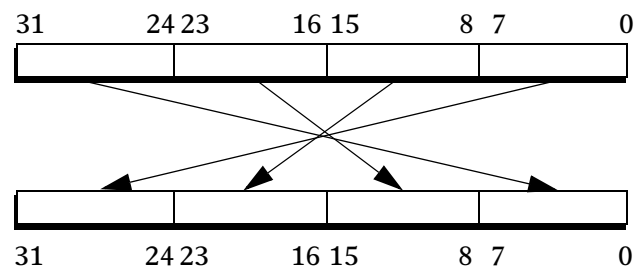

Figure 3-8. BSWAP Doubleword Exchange

A second application of the BSWAP instruction to the same operand restores its original value. The result of applying the BSWAP instruction to a 16-bit register is undefined. To swap bytes of a 16-bit register, use the XCHG instruction.

The BSWAP instruction is used to convert data between little-endian and big-endian byte order.

3.3.4 Load Segment Registers

These instructions load segment registers.

- LDS, LES, LFS, LGS, LSS—Load Far Pointer
- MOV segReg—Move Segment Register
- POP segReg—Pop Stack Into Segment Register

The LDS, LES, LFD, LGS, and LSS instructions atomically load the two parts of a far pointer into a segment register and a general-purpose register. A far pointer is a 16-bit segment selector and a 16-bit or 32-bit offset. The load copies the segment-selector portion of the pointer from memory into the segment register and the offset portion of the pointer from memory into a general-purpose register.

The effective operand size determines the size of the offset loaded by the LDS, LES, LFD, LGS, and LSS instructions. The instructions load not only the software-visible segment selector into the segment register, but they also cause the hardware to load the associated segment-descriptor information into the software-invisible (hidden) portion of that segment register.

The MOV segReg and POP segReg instructions load a segment selector from a general-purpose register or memory (for MOV segReg) or from the top of the stack (for POP segReg) to a segment register. These instructions not only load the software-visible segment selector into the segment register but also cause the hardware to load the associated segment-descriptor information into the software-invisible (hidden) portion of that segment register.

In 64-bit mode, the POP DS, POP ES, and POP SS instructions are invalid.

3.3.5 Load Effective Address

- LEA—Load Effective Address

The LEA instruction calculates and loads the effective address (offset within a given segment) of a source operand and places it in a general-purpose register.

LEA is related to MOV, which copies data from a memory location to a register, but LEA takes the address of the source operand, whereas MOV takes the contents of the memory location specified by the source operand. In the simplest cases, LEA can be replaced with MOV. For example:

```
lea eax, [ebx]
```

has the same effect as:

```
mov eax, ebx
```

However, LEA allows software to use any valid addressing mode for the source operand. For example:

```
lea eax, [ebx+edi]
```

loads the sum of EBX and EDI registers into the EAX register. This could not be accomplished by a single MOV instruction.

LEA has a limited capability to perform multiplication of operands in general-purpose registers using scaled-index addressing. For example:

```
lea eax, [ebx+ebx*8]
```

loads the value of the EBX register, multiplied by 9, into the EAX register.

3.3.6 Arithmetic

The arithmetic instructions perform basic arithmetic operations, such as addition, subtraction, multiplication, and division on integer operands.

Add and Subtract.

- ADC—Add with Carry
- ADD—Signed or Unsigned Add
- SBB—Subtract with Borrow
- SUB—Subtract
- NEG—Two's Complement Negation

The ADD instruction performs addition of two integer operands. There are opcodes that add an immediate value to a byte, word, doubleword, or quadword register or a memory location. In these opcodes, if the size of the immediate is smaller than that of the destination, the immediate is first sign-extended to the size of the destination operand. The arithmetic flags (OF, SF, ZF, AF, CF, PF) are set according to the resulting value of the destination operand.

The ADC instruction performs addition of two integer operands, plus 1 if the carry flag (CF) is set.

The SUB instruction performs subtraction of two integer operands.

The SBB instruction performs subtraction of two integer operands, and it also subtracts an additional 1 if the carry flag is set.

The ADC and SBB instructions simplify addition and subtraction of multiple-precision integer operands, because they correctly handle carries (and borrows) between parts of a multiple-precision operand.

The NEG instruction performs negation of an integer operand. The value of the operand is replaced with the result of subtracting the operand from zero.

Multiply and Divide.

- MUL—Multiply Unsigned
- IMUL—Signed Multiply
- DIV—Unsigned Divide
- IDIV—Signed Divide

The MUL instruction performs multiplication of unsigned integer operands. The size of operands can be byte, word, doubleword, or quadword. The product is stored in a destination which is double the size of the source operands (multiplicand and factor).

The MUL instruction's mnemonic has only one operand, which is a factor. The multiplicand operand is always assumed to be an accumulator register. For byte-sized multiplies, AL contains the multiplicand, and the result is stored in AX. For word-sized, doubleword-sized, and quadword-sized multiplies, rAX contains the multiplicand, and the result is stored in rDX and rAX.

The IMUL instruction performs multiplication of signed integer operands. There are forms of the IMUL instruction with one, two, and three operands, and it is thus more powerful than the MUL instruction. The one-operand form of the IMUL instruction behaves similarly to the MUL instruction, except that the operands and product are signed integer values. In the two-operand form of IMUL, the multiplicand and product use the same register (the first operand), and the factor is specified in the second operand. In the three-operand form of IMUL, the product is stored in the first operand, the multiplicand is specified in the second operand, and the factor is specified in the third operand.

The DIV instruction performs division of unsigned integers. The instruction divides a double-sized dividend in AH:AL or rDX:rAX by the divisor specified in the operand of the instruction. It stores the quotient in AL or rAX and the remainder in AH or rDX.

The IDIV instruction performs division of signed integers. It behaves similarly to DIV, with the exception that the operands are treated as signed integer values.

Division is the slowest of all integer arithmetic operations and should be avoided wherever possible. One possibility for improving performance is to replace division with multiplication, such as by replacing $i/j/k$ with $i/(j*k)$. This replacement is possible if no overflow occurs during the computation of the product. This can be determined by considering the possible ranges of the divisors.

Increment and Decrement.

- DEC—Decrement by 1
- INC—Increment by 1

The INC and DEC instructions are used to increment and decrement, respectively, an integer operand by one. For both instructions, an operand can be a byte, word, doubleword, or quadword register or memory location.

These instructions behave in all respects like the corresponding ADD and SUB instructions, with the second operand as an immediate value equal to 1. The only exception is that the carry flag (CF) is not affected by the INC and DEC instructions.

Apart from their obvious arithmetic uses, the INC and DEC instructions are often used to modify addresses of operands. In this case it can be desirable to preserve the value of the carry flag (to use it later), so these instructions do not modify the carry flag.

3.3.7 Rotate and Shift

The rotate and shift instructions perform cyclic rotation or non-cyclic shift, by a given number of bits (called the *count*), in a given byte-sized, word-sized, doubleword-sized or quadword-sized operand.

When the count is greater than 1, the result of the rotate and shift instructions can be considered as an iteration of the same

1-bit operation by *count* number of times. Because of this, the descriptions below describe the result of 1-bit operations.

The count can be 1, the value of the CL register, or an immediate 8-bit value. To avoid redundancy and make rotation and shifting quicker, the count is masked to the 5 or 6 least-significant bits, depending on the effective operand size, so that its value does not exceed 31 or 63 before the rotation or shift takes place.

Rotate.

- RCL—Rotate Through Carry Left
- RCR—Rotate Through Carry Right
- ROL—Rotate Left
- ROR—Rotate Right

The RCx instructions rotate the bits of the first operand to the left or right by the number of bits specified by the source (count) operand. The bits rotated out of the destination operand are rotated into the carry flag (CF) and the carry flag is rotated into the opposite end of the first operand.

The ROx instructions rotate the bits of the first operand to the left or right by the number of bits specified by the source operand. Bits rotated out are rotated back in at the opposite end. The value of the CF flag is determined by the value of the last bit rotated out. In single-bit left-rotates, the overflow flag (OF) is set to the XOR of the CF flag after rotation and the most-significant bit of the result. In single-bit right-rotates, the OF flag is set to the XOR of the two most-significant bits. Thus, in both cases, the OF flag is set to 1 if the single-bit rotation changed the value of the most-significant bit (sign bit) of the operand. The value of the OF flag is undefined for multi-bit rotates.

Bit-rotation instructions provide many ways to reorder bits in an operand. This can be useful, for example, in character conversion, including cryptography techniques.

Shift.

- SAL—Shift Arithmetic Left
- SAR—Shift Arithmetic Right
- SHL—Shift Left

- SHR—Shift Right
- SHLD—Shift Left Double
- SHRD—Shift Right Double

The SHx instructions (including SHxD) perform shift operations on unsigned operands. The SAx instructions operate with signed operands.

SHL and SAL instructions effectively perform multiplication of an operand by a power of 2, in which case they work as more-efficient alternatives to the MUL instruction. Similarly, SHR and SAR instructions can be used to divide an operand (signed or unsigned, depending on the instruction used) by a power of 2.

Although the SAR instruction divides the operand by a power of 2, the behavior is different from the IDIV instruction. For example, shifting -11 (FFFFFFFF5h) by two bits to the right (i.e. divide -11 by 4), gives a result of FFFFFFFDh, or -3 , whereas the IDIV instruction for dividing -11 by 4 gives a result of -2 . This is because the IDIV instruction rounds off the quotient to zero, whereas the SAR instruction rounds off the remainder to zero for positive dividends, and to negative infinity for negative dividends. This means that, for positive operands, SAR behaves like the corresponding IDIV instruction, and for negative operands, it gives the same result if and only if all the shifted-out bits are zeroes, and otherwise the result is smaller by 1.

The SAR instruction treats the most-significant bit (msb) of an operand in a special way: the msb (the sign bit) is not changed, but is copied to the next bit, preserving the sign of the result. The least-significant bit (lsb) is shifted out to the CF flag. In the SAL instruction, the msb is shifted out to CF flag, and the lsb is cleared to 0.

The SHx instructions perform *logical shift*, i.e. without special treatment of the sign bit. SHL is the same as SAL (in fact, their opcodes are the same). SHR copies 0 into the most-significant bit, and shifts the least-significant bit to the CF flag.

The SHxD instructions perform a double shift. These instructions perform left and right shift of the destination operand, taking the bits to copy into the most-significant bit (for the SHRD instruction) or into the least-significant bit (for the SHLD instruction) from the source operand. These instructions behave like SHx, but use bits from the source

operand instead of zero bits to shift into the destination operand. The source operand is not changed.

3.3.8 Compare and Test

The compare and test instructions perform arithmetic and logical comparison of operands and set corresponding flags, depending on the result of comparison. These instructions are used in conjunction with conditional instructions such as `Jcc` or `SETcc` to organize branching and conditionally executing blocks in programs. Assembler equivalents of conditional operators in high-level languages (`do...while`, `if...then...else`, and similar) also include compare and test instructions.

Compare.

- `CMP`—Compare

The `CMP` instruction performs subtraction of the second operand (source) from the first operand (destination), like the `SUB` instruction, but it does not store the resulting value in the destination operand. It leaves both operands intact. The only effect of the `CMP` instruction is to set or clear the arithmetic flags (`OF`, `SF`, `ZF`, `AF`, `CF`, `PF`) according to the result of subtraction.

The `CMP` instruction is often used together with the conditional jump instructions (`Jcc`), conditional `SET` instructions (`SETcc`) and other instructions such as conditional loops (`LOOPcc`) whose behavior depends on flag state.

Test.

- `TEST`—Test Bits

The `TEST` instruction is in many ways similar to the `AND` instruction: it performs logical conjunction of the corresponding bits of both operands, but unlike the `AND` instruction it leaves the operands unchanged. The purpose of this instruction is to update flags for further testing.

The `TEST` instruction is often used to test whether one or more bits in an operand are zero. In this case, one of the instruction operands would contain a mask in which all bits are cleared to zero except the bits being tested. For more advanced bit testing and bit modification, use the `BTx` instructions.

Bit Scan.

- BSF—Bit Scan Forward
- BSR—Bit Scan Reverse

The BSF and BSR instructions search a source operand for the least-significant (BSF) or most-significant (BSR) bit that is set to 1. If a set bit is found, its bit index is loaded into the destination operand, and the zero flag (ZF) is set. If no set bit is found, the zero flag is cleared and the contents of the destination are undefined.

Bit Test.

- BT—Bit Test
- BTC—Bit Test and Complement
- BTR—Bit Test and Reset
- BTS—Bit Test and Set

The BTx instructions copy a specified bit in the first operand to the carry flag (CF) and leave the source bit unchanged (BT), or complement the source bit (BTC), or clear the source bit to 0 (BTR), or set the source bit to 1 (BTS).

These instructions are useful for implementing semaphore arrays. Unlike the XCHG instruction, the BTx instructions set the carry flag, so no additional test or compare instruction is needed. Also, because these instructions operate directly on bits rather than larger data types, the semaphore arrays can be smaller than is possible when using XCHG. In such semaphore applications, bit-test instructions should be preceded by the LOCK prefix.

Set Byte on Condition.

- SETcc—Set Byte if *condition*

The SETcc instructions store a 1 or 0 value to their byte operand depending on whether their condition (represented by certain rFLAGS bits) is true or false, respectively. Table 3-5 on page 67 shows the rFLAGS values required for each SETcc instruction.

Table 3-5. rFLAGS for SETcc Instructions

Mnemonic	Required Flag State	Description
SETO	OF = 1	Set byte if overflow
SETNO	OF = 0	Set byte if not overflow
SETB SETC SETNAE	CF = 1	Set byte if below Set byte if carry Set byte if not above or equal (unsigned operands)
SETAE SETNB SETNC	CF = 0	Set byte if above or equal Set byte if not below Set byte if not carry (unsigned operands)
SETE SETZ	ZF = 1	Set byte if equal Set byte if zero
SETNE SETNZ	ZF = 0	Set byte if not equal Set byte if not zero
SETBE SETNA	CF = 1 or ZF = 1	Set byte if below or equal Set byte if not above (unsigned operands)
SETA SETNBE	CF = 0 and ZF = 0	Set byte if not below or equal Set byte if not below or equal (unsigned operands)
SETS	SF = 1	Set byte if sign
SETNS	SF = 0	Set byte if not sign
SETP SETPE	PF = 1	Set byte if parity Set byte if parity even
SETNP SETPO	PF = 0	Set byte if not parity Set byte if parity odd
SETL SETNGE	SF <> OF	Set byte if less Set byte if not greater or equal (signed operands)
SETGE SETNL	SF = OF	Set byte if greater or equal Set byte if not less (signed operands)
SETLE SETNG	ZF = 1 or SF <> OF	Set byte if less or equal Set byte if not greater (signed operands)
SETG SETNLE	ZF = 0 and SF = OF	Set byte if greater Set byte if not less or equal (signed operands)

SETcc instructions are often used to set logical indicators. Like CMOVcc instructions (page 50), SETcc instructions can replace two instructions—a conditional jump and a move. Replacing conditional jumps with conditional sets can help avoid branch-prediction penalties that may be caused by conditional jumps.

If the logical value True (logical 1) is represented in a high-level language as an integer with all bits set to 1, software can accomplish such representation by first executing the opposite SETcc instruction—for example, the opposite of SETZ is SETNZ—and then decrementing the result.

Bounds.

- BOUND—Check Array Bounds

The BOUND instruction checks whether the value of the first operand, a signed integer index into an array, is within the minimal and maximal bound values pointed to by the second operand. The values of array bounds are often stored at the beginning of the array. If the bounds of the range are exceeded, the processor generates a bound-range exception.

The primary disadvantage of using the BOUND instruction is its use of the time-consuming exception mechanism to signal a failure of the bounds test.

3.3.9 **Logical**

The logical instructions perform bitwise operations.

- AND—Logical AND
- OR—Logical OR
- XOR—Exclusive OR
- NOT—One's Complement Negation

The AND, OR, and XOR instructions perform their respective logical operations on the corresponding bits of both operands and store the result in the first operand. The CF flag and OF flag are cleared to 0, and the ZF flag, SF flag, and PF flag are set according to the resulting value of the first operand.

The NOT instruction performs logical inversion of all bits of its operand. Each zero bit becomes one and vice versa. All flags remain unchanged.

Apart from performing logical operations, AND and OR can test a register for a zero or non-zero value, sign (negative or positive), and parity status of its lowest byte. To do this, both

operands must be the same register. The XOR instruction with two identical operands is an efficient way of loading the value 0 into a register.

3.3.10 String

The string instructions perform common string operations such as copying, moving, comparing, or searching strings. These instructions are widely used for processing text.

Compare Strings.

- CMPS—Compare Strings
- CMPSB—Compare Strings by Byte
- CMPSW—Compare Strings by Word
- CMPSD—Compare Strings by Doubleword
- CMPSQ—Compare Strings by Quadword

The CMPS x instructions compare the values of two implicit operands of the same size located at $seg:[rSI]$ and $ES:[rDI]$. After the copy, both the rSI and rDI registers are auto-incremented (if the DF flag is 0) or auto-decremented (if the DF flag is 1).

Scan String.

- SCAS—Scan String
- SCASB—Scan String as Bytes
- SCASW—Scan String as Words
- SCASD—Scan String as Doubleword
- SCASQ—Scan String as Quadword

The SCAS x instructions compare the values of a memory operands in $ES:rDI$ to a value of the same size in the AL/rAX register. Bits in $rFLAGS$ are set to indicate the outcome of the comparison. After the comparison, the rDI register is auto-incremented (if the DF flag is 0) or auto-decremented (if the DF flag is 1).

Move String.

- MOVS—Move String
- MOVSB—Move String Byte
- MOVSW—Move String Word
- MOVSD—Move String Doubleword
- MOVSQ—Move String Quadword

The MOV S_x instructions copy an operand from the memory location $seg:[rSI]$ to the memory location $ES:[rDI]$. After the copy, both the rSI and rDI registers are auto-incremented (if the DF flag is 0) or auto-decremented (if the DF flag is 1).

Load String.

- LODS—Load String
- LODSB—Load String Byte
- LODSW—Load String Word
- LODSD—Load String Doubleword
- LODSQ—Load String Quadword

The LOD S_x instructions load a value from the memory location $seg:[rSI]$ to the accumulator register (AL or rAX). After the load, the rSI register is auto-incremented (if the DF flag is 0) or auto-decremented (if the DF flag is 1).

Store String.

- STOS—Store String
- STOSB—Store String Bytes
- STOSW—Store String Words
- STOSD—Store String Doublewords
- STOSQ—Store String Quadword

The STOS x instructions copy the accumulator register (AL or rAX) to a memory location $ES:[rDI]$. After the copy, the rDI register is auto-incremented (if the DF flag is 0) or auto-decremented (if the DF flag is 1).

3.3.11 Control Transfer

Control-transfer instructions, or branches, are used to iterate through loops and move through conditional program logic.

Jump.

- JMP—Jump

JMP performs an unconditional jump to the specified address. There are several ways to specify the target address.

- *Relative Short Jump* and *Relative Near Jump*—The target address is determined by adding an 8-bit (short jump) or 16-bit or 32-bit (near jump) signed displacement to the rIP of the instruction following the JMP. The jump is performed within the current code segment (CS).

- *Register-Indirect and Memory-Indirect Near Jump*—The target rIP value is contained in a register or in a memory location. The jump is performed within the current CS.
- *Direct Far Jump*—For all far jumps, the target address is outside the current code segment. Here, the instruction specifies the 16-bit target-address code segment and the 16-bit or 32-bit offset as an immediate value. The direct far jump form is invalid in 64-bit mode.
- *Memory-Indirect Far Jump*—For this form, the target address (CS:rIP) is in an address outside the current code segment. A 32-bit or 48-bit far pointer in a specified memory location points to the target address.

The size of the target rIP is determined by the effective operand size for the JMP instruction.

For far jumps, the target selector can specify a code-segment selector, in which case it is loaded into CS, and a 16-bit or 32-bit target offset is loaded into rIP. The target selector can also be a call-gate selector or a task-state-segment (TSS) selector, used for performing task switches. In these cases, the target offset of the JMP instruction is ignored, and the new values loaded into CS and rIP are taken from the call gate or from the TSS.

Conditional Jump.

- *Jcc*—Jump if *condition*

Conditional jump instructions jump to an instruction specified by the operand, depending on the state of flags in the rFLAGS register. The operand specifies a signed relative offset from the current contents of the rIP. If the state of the corresponding flags meets the condition, a conditional jump instruction passes control to the target instruction, otherwise control is passed to the instruction following the conditional jump instruction. The flags tested by a specific *Jcc* instruction depend on the opcode. In several cases, multiple mnemonics correspond to one opcode.

Table 3-6 on page 72 shows the rFLAGS values required for each *Jcc* instruction.

Table 3-6. rFLAGS for Jcc Instructions

Mnemonic	Required Flag State	Description
JO	OF = 1	Jump near if overflow
JNO	OF = 0	Jump near if not overflow
JB JC JNAE	CF = 1	Jump near if below Jump near if carry Jump near if not above or equal
JNB JNC JAE	CF = 0	Jump near if not below Jump near if not carry Jump near if above or equal
JZ JE	ZF = 1	Jump near if 0 Jump near if equal
JNZ JNE	ZF = 0	Jump near if not zero Jump near if not equal
JNA JBE	CF = 1 or ZF = 1	Jump near if not above Jump near if below or equal
JNBE JA	CF = 0 and ZF = 0	Jump near if not below or equal Jump near if above
JS	SF = 1	Jump near if sign
JNS	SF = 0	Jump near if not sign
JP JPE	PF = 1	Jump near if parity Jump near if parity even
JNP JPO	PF = 0	Jump near if not parity Jump near if parity odd
JL JNGE	SF \diamond OF	Jump near if less Jump near if not greater or equal
JGE JNL	SF = OF	Jump near if greater or equal Jump near if not less
JNG JLE	ZF = 1 or SF \diamond OF	Jump near if not greater Jump near if less or equal
JNLE JG	ZF = 0 and SF = OF	Jump near if not less or equal Jump near if greater

Unlike the unconditional jump (JMP), conditional jump instructions have only two forms—*near conditional jumps* and *short conditional jumps*. To create a far-conditional-jump code sequence corresponding to a high-level language statement like:

```
IF A = B THEN GOTO FarLabel
```

where `FarLabel` is located in another code segment, use the opposite condition in a conditional short jump before the unconditional far jump. For example:

```
cmp    A,B                ; compare operands
jne    NextInstr          ; continue program if not equal
jmp    far ptr WhenNE     ; far jump if operands are equal
NextInstr:                ; continue program
```

Three special conditional jump instructions use the `rCX` register instead of flags. The `JCXZ`, `JECXZ`, and `JRCXZ` instructions check the value of the `CX`, `ECX`, and `RCX` registers, respectively, and pass control to the target instruction when the value of `rCX` register reaches 0. These instructions are often used to control safe cycles, preventing execution when the value in `rCX` reaches 0.

Loop.

- `LOOPcc`—Loop if *condition*

The `LOOPcc` instructions include `LOOPE`, `LOOPNE`, `LOOPNZ`, and `LOOPZ`. These instructions decrement the `rCX` register by 1 without changing any flags, and then check to see if the loop condition is met. If the condition is met, the program jumps to the specified target code.

`LOOPE` and `LOOPZ` are synonyms. Their loop condition is met if the value of the `rCX` register is non-zero and the zero flag (`ZF`) is set to 1 when the instruction starts. `LOOPNE` and `LOOPNZ` are also synonyms. Their loop condition is met if the value of the `rCX` register is non-zero and the `ZF` flag is cleared to 0 when the instruction starts. `LOOP`, unlike the other mnemonics, does not check the `ZF` flag. Its loop condition is met if the value of the `rCX` register is non-zero.

Call.

- `CALL`—Procedure Call

The CALL instruction performs a call to a procedure whose address is specified in the operand. The return address is placed on the stack by the CALL, and points to the instruction immediately following the CALL. When the called procedure finishes execution and is exited using a return instruction, control is transferred to the return address saved on the stack.

The CALL instruction has the same forms as the JMP instruction, except that CALL lacks the short-relative (1-byte offset) form.

- *Relative Near Call*—These specify an offset relative to the instruction following the CALL instruction. The operand is an immediate 16-bit or 32-bit offset from the called procedure, within the same code segment.
- *Register-Indirect and Memory-Indirect Near Call*—These specify a target address contained in a register or memory location.
- *Direct Far Call*—These specify a target address outside the current code segment. The address is pointed to by a 32-bit or 48-bit far-pointer specified by the instruction, which consists of a 16-bit code selector and a 16-bit or 32-bit offset. The direct far call form is invalid in 64-bit mode.
- *Memory-Indirect Far Call*—These specify a target address outside the current code segment. The address is pointed to by a 32-bit or 48-bit far pointer in a specified memory location.

The size of the rIP is in all cases determined by the operand-size attribute of the CALL instruction. CALLs push the return address to the stack. The data pushed on the stack depends on whether a near or far call is performed, and whether a privilege change occurs. See Section 3.7.5, “Procedure Calls,” on page 98 for further information.

For far CALLs, the selector portion of the target address can specify a code-segment selector (in which case the selector is loaded into the CS register), or a call-gate selector, (used for calls that change privilege level), or a task-state-segment (TSS) selector (used for task switches). In the latter two cases, the offset portion of the CALL instruction’s target address is ignored, and the new values loaded into CS and rIP are taken from the call gate or TSS.

Return.

- RET—Return from Call

The RET instruction returns from a procedure originally called using the CALL instruction. CALL places a return address (which points to the instruction following the CALL) on the stack. RET takes the return address from the stack and transfers control to the instruction located at that address.

Like CALL instructions, RET instructions have both a near and far form. An optional immediate operand for the RET specifies the number of bytes to be popped from the procedure stack for parameters placed on the stack. See Section 3.7.6, “Returning from Procedures,” on page 101 for additional information.

Interrupts and Exceptions.

- INT—Interrupt to Vector Number
- INTO—Interrupt to Overflow Vector
- IRET—Interrupt Return Word
- IRETD—Interrupt Return Doubleword
- IRETQ—Interrupt Return Quadword

The INT instruction implements a *software interrupt* by calling an interrupt handler. The operand of the INT instruction is an immediate byte value specifying an index in the interrupt descriptor table (IDT), which contains addresses of interrupt handlers (see Section 3.7.10, “Interrupts and Exceptions,” on page 106 for further information on the IDT).

The 1-byte INTO instruction calls interrupt 4 (the overflow exception, #OF), if the overflow flag in RFLAGS is set to 1, otherwise it does nothing. Signed arithmetic instructions can be followed by the INTO instruction if the result of the arithmetic operation can potentially overflow. (The 1-byte INT 3 instruction is considered a system instruction and is therefore not described in this volume).

IRET, IRETD, and IRETQ perform a return from an interrupt handler. The mnemonic specifies the operand size, which determines the format of the return addresses popped from the stack (IRET for 16-bit operand size, IRETD for 32-bit operand size, and IRETQ for 64-bit operand size). However, some assemblers can use the IRET mnemonic for all operand sizes. Actions performed by IRET are opposite to actions performed

by an interrupt or exception. In real and protected mode, IRET pops the rIP, CS, and RFLAGS contents from the stack, and it pops SS:rSP if a privilege-level change occurs or if it executes from 64-bit mode. In protected mode, the IRET instruction can also cause a task switch if the nested task (NT) bit in the RFLAGS register is set. For details on using IRET to switch tasks, see “Task Management” in Volume 2.

3.3.12 **Flags**

The flags instructions read and write bits of the RFLAGS register that are visible to application software. “Flags Register” on page 38 illustrates the RFLAGS register.

Push and Pop Flags.

- POPF—Pop to FLAGS Word
- POPFD—Pop to EFLAGS Doubleword
- POPFQ—Pop to RFLAGS Quadword
- PUSHF—Push FLAGS Word onto Stack
- PUSHFD—Push EFLAGS Doubleword onto Stack
- PUSHFQ—Push RFLAGS Quadword onto Stack

The push and pop flags instructions copy data between the rFLAGS register and the stack. POPF and PUSHF copy 16 bits of data between the stack and the FLAGS register (the low 16 bits of EFLAGS), leaving the high 48 bits of RFLAGS unchanged. POPFD and PUSHFD copy 32 bits between the stack and the RFLAGS register. POPFQ and PUSHFQ copy 64 bits between the stack and the RFLAGS register. Only the bits illustrated in Figure 3-5 on page 39 are affected. Reserved bits and bits whose writability is prevented by the current values of system flags, current privilege level (CPL), or current operating mode, are unaffected by the POPF, POPFQ, and POPFD instructions.

For details on stack operations, see “Control Transfers” on page 94.

Set and Clear Flags.

- CLC—Clear Carry Flag
- CMC—Complement Carry Flag
- STC—Set Carry Flag
- CLD—Clear Direction Flag
- STD—Set Direction Flag

- CLI—Clear Interrupt Flag
- STI—Set Interrupt Flag

These instructions change the value of a flag in the rFLAGS register that is visible to application software. Each instruction affects only one specific flag.

The CLC, CMC, and STC instructions change the carry flag (CF). CLC clears the flag to 0, STC sets the flag to 1, and CMC inverts the flag. These instructions are useful prior to executing instructions whose behavior depends on the CF flag—for example, shift and rotate instructions.

The CLD and STD instructions change the direction flag (DF) and influence the function of string instructions (CMPSx, SCASx, MOVSx, LODSx, STOSx, INSx, OUTSx). CLD clears the flag to 0, and STD sets the flag to 1. A cleared DF flag indicates the *forward* direction in string sequences, and a set DF flag indicates the *backward* direction. Thus, in string instructions, the rSI and/or rDI register values are auto-incremented when DF = 0 and auto-decremented when DF = 1.

Two other instructions, CLI and STI, clear and set the interrupt flag (IF). CLI clears the flag, causing the processor to ignore external maskable interrupts. STI sets the flag, allowing the processor to recognize maskable external interrupts. These instructions are used primarily by system software—especially, interrupt handlers—and are described in “Exceptions and Interrupts” in Volume 2.

Load and Store Flags.

- LAHF—Load Status Flags into AH Register
- SAHF—Store AH into Flags

LAHF loads the lowest byte of the RFLAGS register into the AH register. This byte contains the carry flag (CF), parity flag (PF), auxiliary flag (AF), zero flag (ZF), and sign flag (SF). SAHF stores the AH register into the lowest byte of the RFLAGS register.

3.3.13 Input/Output

The I/O instructions perform reads and writes of bytes, words, and doublewords from and to the *I/O address space*. This address space can be used to access and manage external devices, and is independent of the main-memory address space. By contrast, *memory-mapped I/O* uses the main-memory address space and is

accessed using the MOV instructions rather than the I/O instructions.

When operating in legacy protected mode or in long mode, the RFLAGS register's I/O privilege level (IOPL) field and the I/O-permission bitmap in the current task-state segment (TSS) are used to control access to the I/O addresses (called *I/O ports*). See “Input/Output” on page 111 for further information.

General I/O.

- IN—Input from Port
- OUT—Output to Port

The IN instruction reads a byte, word, or doubleword from the I/O port address specified by the source operand, and loads it into the accumulator register (AL or eAX). The source operand can be an immediate byte or the DX register.

The OUT instruction writes a byte, word, or doubleword from the accumulator register (AL or eAX) to the I/O port address specified by the destination operand, which can be either an immediate byte or the DX register.

If the I/O port address is specified with an immediate operand, the range of port addresses accessible by the IN and OUT instructions is limited to ports 0 through 255. If the I/O port address is specified by a in the DX register, all 65,536 ports are accessible.

String I/O.

- INS—Input String
- INSB—Input String Byte
- INSW—Input String Word
- INSD—Input String Doubleword
- OUTS—Output String
- OUTSB—Output String Byte
- OUTSW—Output String Word
- OUTSD—Output String Doubleword

The *INSx* instructions (INSB, INSW, INSD) read a byte, word, or doubleword from the I/O port specified by the DX register, and load it into the memory location specified by ES:[rDI].

The OUTS_x instructions (OUTSB, OUTSW, OUTSD) write a byte, word, or doubleword from an implicit memory location specified by *seg:[rSI]*, to the I/O port address stored in the DX register.

The INS_x and OUTS_x instructions are commonly used with a repeat prefix to transfer blocks of data. The memory pointer address is not incremented or decremented. This usage is intended for peripheral I/O devices that are expecting a stream of data.

3.3.14 Semaphores

The semaphore instructions support the implementation of reliable signaling between processors in a multi-processing environment, usually for the purpose of sharing resources.

- CMPXCHG—Compare and Exchange
- CMPXCHG8B—Compare and Exchange Eight Bytes
- CMPXCHG16B—Compare and Exchange Sixteen Bytes
- XADD—Exchange and Add
- XCHG—Exchange

The CMPXCHG instruction compares a value in the AL or rAX register with the first (destination) operand, and sets the arithmetic flags (ZF, OF, SF, AF, CF, PF) according to the result. If the compared values are equal, the source operand is loaded into the destination operand. If they are not equal, the first operand is loaded into the accumulator. CMPXCHG can be used to try to intercept a semaphore, i.e. test if its state is *free*, and if so, load a new value into the semaphore, making its state *busy*. The test and load are performed atomically, so that concurrent processes or threads which use the semaphore to access a shared object will not conflict.

The CMPXCHG8B instruction compares the 64-bit values in the EDX:EAX registers with a 64-bit memory location. If the values are equal, the zero flag (ZF) is set, and the ECX:EBX value is copied to the memory location. Otherwise, the ZF flag is cleared, and the memory value is copied to EDX:EAX.

The CMPXCHG16B instruction compares the 128-bit value in the RDX:RAX and RCX:RBX registers with a 128-bit memory location. If the values are equal, the zero flag (ZF) is set, and the RCX:RBX value is copied to the memory location. Otherwise, the ZF flag is cleared, and the memory value is copied to rDX:rAX.

The XADD instruction exchanges the values of its two operands, then it stores their sum in the first (destination) operand.

A LOCK prefix can be used to make the CMPXCHG, CMPXCHG8B and XADD instructions atomic if one of the operands is a memory location.

The XCHG instruction exchanges the values of its two operands. If one of the operands is in memory, the processor's bus-locking mechanism is engaged automatically during the exchange, whether or not the LOCK prefix is used.

3.3.15 Processor Information

■ CPUID—Processor Identification

The CPUID instruction returns information about the processor implementation and its support for instruction subsets and architectural features. Software operating at any privilege level can execute the CPUID instruction to read this information. After the information is read, software can select procedures that optimize performance for a particular hardware implementation.

Some processor implementations may not support the CPUID instruction. Support for the CPUID instruction is determined by testing the RFLAGS.ID bit. If software can write this bit, then the CPUID instruction is supported by the processor implementation. Otherwise, execution of CPUID results in an invalid-opcode exception.

See “Feature Detection” on page 92 for details about using the CPUID instruction. For a full description of the CPUID instruction and its function codes, see “CPUID” in Volume 3 and the *AMD Processor Recognition Application Note*, order# 20734.

3.3.16 Cache and Memory Management

Applications can use the cache and memory-management instructions to control memory reads and writes to influence the caching of read/write data. “Memory Optimization” on page 115 describes how these instructions interact with the memory subsystem.

- LFENCE—Load Fence
- SFENCE—Store Fence
- MFENCE—Memory Fence
- PREFETCH $level$ —Prefetch Data to Cache Level $level$

- PREFETCH—Prefetch L1 Data-Cache Line
- PREFETCHW—Prefetch L1 Data-Cache Line for Write
- CLFLUSH—Cache Line Invalidate

The LFENCE, SFENCE, and MFENCE instructions can be used to force ordering on memory accesses. The order of memory accesses can be important when the reads and writes are to a memory-mapped I/O device, and in multiprocessor environments where memory synchronization is required. LFENCE affects ordering on memory reads, but not writes. SFENCE affects ordering on memory writes, but not reads. MFENCE orders both memory reads and writes. These instructions do not take operands. They are simply inserted between the memory references that are to be ordered. For details about the fence instructions, see “Forcing Memory Order” on page 117.

The PREFETCH $level$, PREFETCH, and PREFETCHW instructions load data from memory into one or more cache levels. PREFETCH $level$ loads a memory block into a specified level in the data-cache hierarchy (including a non-temporal caching level). The size of the memory block is implementation dependent. PREFETCH loads a cache line into the L1 data cache. PREFETCHW loads a cache line into the L1 data cache and sets the cache line’s memory-coherency state to *modified*, in anticipation of subsequent data writes to that line. (Both PREFETCH and PREFETCHW are 3DNow!™ instructions.) For details about the prefetch instructions, see “Cache-Control Instructions” on page 124. For a description of MOESI memory-coherency states, see “Memory System” in Volume 2.

The CLFLUSH instruction writes unsaved data back to memory for the specified cache line from all processor caches, invalidates the specified cache, and causes the processor to send a bus cycle which signals external caching devices to write back and invalidate their copies of the cache line. CLFLUSH provides a finer-grained mechanism than the WBINVD instruction, which writes back and invalidates all cache lines. Moreover, CLFLUSH can be used at all privilege levels, unlike WBINVD which can be used only by system software running at privilege level 0.

3.3.17 No Operation

- NOP—No Operation

The NOP instructions performs no operation (except incrementing the instruction pointer rIP by one). It is an alternative mnemonic for the XCHG rAX, rAX instruction. Depending on the hardware implementation, the NOP instruction may use one or more cycles of processor time.

3.3.18 System Calls

System Call and Return.

- SYSENTER—System Call
- SYSEXIT—System Return
- SYSCALL—Fast System Call
- SYSRET—Fast System Return

The SYSENTER and SYSCALL instructions perform a call to a routine running at current privilege level (CPL) 0—for example, a kernel procedure—from a user level program (CPL 3). The addresses of the target procedure and (for SYSENTER) the target stack are specified implicitly through the model-specific registers (MSRs). Control returns from the operating system to the callee when the operating system executes a SYSEXIT or SYSRET instruction. SYSEXIT and SYSRET are privileged instructions and thus can be issued only by a privilege-level-0 procedure.

The SYSENTER and SYSEXIT instructions form a complementary pair, as do SYSCALL and SYSRET. SYSENTER and SYSEXIT are invalid in 64-bit mode. In this case, use the faster SYSCALL and SYSRET instructions.

For details on these and other system-related instructions, see “System-Management Instructions” in Volume 2 and “System Instruction Reference” in Volume 3.

3.4 General Rules for Instructions in 64-Bit Mode

This section provides details of the general-purpose instructions in 64-bit mode, and how they differ from the same instructions in legacy and compatibility modes. The differences apply only to general-purpose instructions. Most of them do not apply to 128-bit media, 64-bit media, or x87 floating-point instructions.

3.4.1 Address Size

In 64-bit mode, the following rules apply to address size:

- Defaults to 64 bits.

- Can be overridden to 32 bits (by means of opcode prefix 67h).
- Can't be overridden to 16 bits.

3.4.2 Canonical Address Format

Bits 63 through the most-significant implemented virtual-address bit must be all zeros or all ones in any memory reference. See “64-bit Canonical Addresses” on page 18 for details. (This rule applies to long mode, which includes both 64-bit mode and compatibility mode.)

3.4.3 Branch-Displacement Size

Branch-address displacements are 8 bits or 32 bits, as in legacy mode, but are sign-extended to 64 bits prior to using them for address computations. See “Displacements and Immediates” on page 20 for details.

3.4.4 Operand Size

In 64-bit mode, the following rules apply to operand size:

- **64-Bit Operand Size Option:** If an instruction's operand size (16-bit or 32-bit) in legacy mode depends on the default-size (D) bit in the current code-segment descriptor and the operand-size prefix, then the operand-size choices in 64-bit mode are extended from 16-bit and 32-bit to include 64 bits (with a REX prefix), or the operand size is fixed at 64 bits. See “General-Purpose Instructions in 64-Bit Mode” in Volume 3 for details.
- **Default Operand Size:** The default operand size for most instructions is 32 bits, and a REX prefix must be used to change the operand size to 64 bits. However, two groups of instructions default to 64-bit operand size and do not need a REX prefix: (1) near branches and (2) all instructions, except far branches, that implicitly reference the RSP. See “General-Purpose Instructions in 64-Bit Mode” in Volume 3 for details.
- **Fixed Operand Size:** If an instruction's operand size is fixed in legacy mode, that operand size is usually fixed at the same size in 64-bit mode. (There are some exceptions.) For example, the CPUID instruction always operates on 32-bit operands, irrespective of attempts to override the operand size. See “General-Purpose Instructions in 64-Bit Mode” in Volume 3 for details.
- **Immediate Operand Size:** The maximum size of immediate operands is 32 bits, as in legacy mode, except that 64-bit immediates can be MOVED into 64-bit GPRs. When the operand size is 64 bits, immediates are sign-extended to 64

bits prior to using them. See “Immediate Operand Size” on page 47 for details.

- **Shift-Count and Rotate-Count Operand Size:** When the operand size is 64 bits, shifts and rotates use one additional bit (6 bits total) to specify shift-count or rotate-count, allowing 64-bit shifts and rotates.

3.4.5 High 32 Bits

In 64-bit mode, the following rules apply to extension of results into the high 32 bits when results smaller than 64 bits are written:

- **Zero-Extension of 32-Bit Results:** 32-bit results are zero-extended into the high 32 bits of 64-bit GPR destination registers.
- **No Extension of 8-Bit and 16-Bit Results:** 8-bit and 16-bit results leave the high 56 or 48 bits, respectively, of 64-bit GPR destination registers unchanged.
- **Undefined High 32 Bits After Mode Change:** The processor does not preserve the upper 32 bits of the 64-bit GPRs across changes from 64-bit mode to compatibility or legacy modes. In compatibility and legacy mode, the upper 32 bits of the GPRs are undefined and not accessible to software.

3.4.6 Invalid and Reassigned Instructions

The following general-purpose instructions are invalid in 64-bit mode:

- AAA—ASCII Adjust After Addition
- AAD—ASCII Adjust Before Division
- AAM—ASCII Adjust After Multiply
- AAS—ASCII Adjust After Subtraction
- BOUND—Check Array Bounds
- CALL (far absolute)—Procedure Call Far
- DAA—Decimal Adjust after Addition
- DAS—Decimal Adjust after Subtraction
- INTO—Interrupt to Overflow Vector
- JMP (far absolute)—Jump Far
- LDS—Load DS Segment Register
- LES—Load ES Segment Register
- POP DS—Pop Stack into DS Segment
- POP ES—Pop Stack into ES Segment
- POP SS—Pop Stack into SS Segment
- POPA, POPAD—Pop All to GPR Words or Doublewords
- PUSH CS—Push CS Segment Selector onto Stack
- PUSH DS—Push DS Segment Selector onto Stack
- PUSH ES—Push ES Segment Selector onto Stack
- PUSH SS—Push SS Segment Selector onto Stack

- PUSHA, PUSHAD—Push All to GPR Words or Doublewords

The following general-purpose instructions are invalid in long mode (64-bit mode and compatibility mode):

- SYSENTER—System Call (use SYSCALL instead)
- SYSEXIT—System Exit (use SYSRET instead)

The opcodes for the following general-purpose instructions are reassigned in 64-bit mode:

- ARPL—Adjust Requestor Privilege Level. Opcode becomes the MOVSXD instruction.
- DEC (one-byte opcode only)—Decrement by 1. Opcode becomes a REX prefix. Use the two-byte DEC opcode instead.
- INC (one-byte opcode only)—Increment by 1. Opcode becomes a REX prefix. Use the two-byte INC opcode instead.

3.4.7 Instructions with 64-Bit Default Operand Size

Most instructions default to 32-bit operand size in 64-bit mode. However, the following near branches instructions and instructions that implicitly reference the stack pointer (RSP) default to 64-bit operand size in 64-bit mode:

- *Near Branches:*
 - Jcc—Jump Conditional Near
 - JMP—Jump Near
 - LOOP—Loop
 - LOOPcc—Loop Conditional
- *Instructions That Implicitly Reference RSP:*
 - ENTER—Create Procedure Stack Frame
 - LEAVE—Delete Procedure Stack Frame
 - POP *reg/mem*—Pop Stack (register or memory)
 - POP *reg*—Pop Stack (register)
 - POP FS—Pop Stack into FS Segment Register
 - POP GS—Pop Stack into GS Segment Register
 - POPF, POPFD, POPFQ—Pop to rFLAGS Word, Doubleword, or Quadword
 - PUSH *imm32*—Push onto Stack (sign-extended doubleword)
 - PUSH *imm8*—Push onto Stack (sign-extended byte)

- PUSH *reg/mem*—Push onto Stack (register or memory)
- PUSH *reg*—Push onto Stack (register)
- PUSH FS—Push FS Segment Register onto Stack
- PUSH GS—Push GS Segment Register onto Stack
- PUSHF, PUSHFD, PUSHFQ—Push rFLAGS Word, Doubleword, or Quadword onto Stack

The default 64-bit operand size eliminates the need for a REX prefix with these instructions when registers RAX–RSP (the first set of eight GPRs) are used as operands. A REX prefix is still required if R8–R15 (the extended set of eight GPRs) are used as operands, because the prefix is required to address the extended registers.

The 64-bit default operand size can be overridden to 16 bits using the 66h operand-size override. However, it is not possible to override the operand size to 32 bits, because there is no 32-bit operand-size override prefix for 64-bit mode. For details on the operand-size prefix, see “Instruction Prefixes” in Volume 3.

For details on near branches, see “Near Branches in 64-Bit Mode” on page 105. For details on instructions that implicitly reference RSP, see “Stack Operand-Size in 64-Bit Mode” on page 96.

For details on opcodes and operand-size overrides, see “General-Purpose Instructions in 64-Bit Mode” in Volume 3.

3.5 Instruction Prefixes

An instruction prefix is a byte that precedes an instruction’s opcode and modifies the instruction’s operation or operands. Instruction prefixes are of two types:

- Legacy Prefixes
- REX Prefixes

Legacy prefixes are organized into five groups, in which each prefix has a unique value. REX prefixes, which enable use of the AMD64 register extensions in 64-bit mode, are organized as a single group in which the value of the prefix indicates the combination of register-extension features to be enabled.

3.5.1 Legacy Prefixes

Table 3-7 shows the legacy prefixes. These are organized into five groups, as shown in the left-most column of the table. Each

prefix has a unique hexadecimal value. The legacy prefixes can appear in any order in the instruction, but only one prefix from each of the five groups can be used in a single instruction. The result of using multiple prefixes from a single group is undefined.

There are several restrictions on the use of prefixes. For example, the address-size prefix changes address size only for a memory operand, and only a single memory operand can be overridden in an instruction. In general, the operand-size prefix cannot be used with x87 floating-point instructions, and when used with 128-bit or 64-bit media instructions that prefix acts in a special way to modify the opcode. The repeat prefixes cause repetition only with certain string instructions, and when used with 128-bit or 64-bit media instructions the prefixes act in a special way to modify the opcode. The lock prefix can be used with only a small number of general-purpose instructions.

Table 3-7 summarizes the functionality of instruction prefixes. Details about the prefixes and their restrictions are given in “Instruction Prefixes” in Volume 3.

Table 3-7. Legacy Instruction Prefixes

Prefix Group	Mnemonic	Prefix Code (Hex)	Description
Operand-Size Override	none	66 ¹	Changes the default operand size of a memory or register operand, as shown in Table 3-3 on page 46.
Address-Size Override	none	67	Changes the default address size of a memory operand, as shown in Table 2-1 on page 21.
Note:			
1. When used with 128-bit or 64-bit media instructions, this prefix acts in a special-purpose way to modify the opcode.			

Table 3-7. Legacy Instruction Prefixes (continued)

Prefix Group	Mnemonic	Prefix Code (Hex)	Description
Segment Override	CS	2E	Forces use of the CS segment for memory operands.
	DS	3E	Forces use of the DS segment for memory operands.
	ES	26	Forces use of the ES segment for memory operands.
	FS	64	Forces use of the FS segment for memory operands.
	GS	65	Forces use of the GS segment for memory operands.
	SS	36	Forces use of the SS segment for memory operands.
Lock	LOCK	F0	Causes certain read-modify-write instructions on memory to occur atomically.
Repeat	REP	F3 ¹	Repeats a string operation (INS, MOVS, OUTS, LODS, and STOS) until the rCX register equals 0.
	REPE or REPZ		Repeats a compare-string or scan-string operation (CMPSx and SCASx) until the rCX register equals 0 or the zero flag (ZF) is cleared to 0.
	REPNE or REPNZ	F2 ¹	Repeats a compare-string or scan-string operation (CMPSx and SCASx) until the rCX register equals 0 or the zero flag (ZF) is set to 1.
Note:			
1. When used with 128-bit or 64-bit media instructions, this prefix acts in a special-purpose way to modify the opcode.			

Operand-Size and Address-Size Prefixes. The operand-size and address-size prefixes allow mixing of data and address sizes on an instruction-by-instruction basis. An instruction's default address size can be overridden in any operating mode by using the 67h address-size prefix.

Table 3-3 on page 46 shows the operand-size overrides for all operating modes. In 64-bit mode, the default operand size for most general-purpose instructions is 32 bits. A REX prefix (described in “REX Prefixes” on page 91) specifies a 64-bit operand size, and a 66h prefix specifies a 16-bit operand size. The REX prefix takes precedence over the 66h prefix.

Table 2-1 on page 21 shows the address-size overrides for all operating modes. In 64-bit mode, the default address size is 64 bits. The address size can be overridden to 32 bits. 16-bit addresses are not supported in 64-bit mode. In compatibility mode, the address-size prefix works the same as in the legacy x86 architecture.

For further details on these prefixes, see “Operand-Size Override Prefix” in Volume 3 and “Address-Size Override Prefix” in Volume 3.

Segment Override Prefix. The DS segment is the default segment for most memory operands. Many instructions allow this default data segment to be overridden using one of the six segment-override prefixes shown in Table 3-7. Data-segment overrides will be ignored when accessing data in the following cases:

- When a stack reference is made that pushes data onto or pops data off of the stack. In those cases, the SS segment is always used.
- When the destination of a string is memory it is always referenced using the ES segment.

Instruction fetches from the CS segment cannot be overridden. However, the CS segment-override prefix can be used to access instructions as data objects and to access data stored in the code segment.

For further details on these prefixes, see “Segment-Override Prefixes” in Volume 3.

Lock Prefix. The LOCK prefix causes certain read-modify-write instructions that access memory to occur atomically. The mechanism for doing so is implementation-dependent (for example, the mechanism may involve locking of data-cache lines that contain copies of the referenced memory operands, and/or bus signaling or packet-messaging on the bus). The prefix is intended to give the processor exclusive use of shared memory operands in a multiprocessor system.

The prefix can only be used with forms of the following instructions that write a memory operand: ADC, ADD, AND, BTC, BTR, BTS, CMPXCHG, CMPXCHG8B, DEC, INC, NEG, NOT, OR, SBB, SUB, XADD, XCHG, and XOR. An invalid-opcode exception occurs if LOCK is used with any other instruction.

For further details on these prefixes, see “Lock Prefix” in Volume 3.

Repeat Prefixes. There are two repeat prefixes byte codes, F3h and F2h. Byte code F3h is the more general and is usually treated as two distinct instructions by assemblers. Byte code F2h is only used with CMPSx and SCASx instructions:

- REP (F3h)—This more generalized repeat prefix repeats its associated string instruction the number of times specified in the counter register (rCX). Repetition stops when the value in rCX reaches 0. This prefix is used with the INS, LODS, MOVS, OUTS, and STOS instructions.
- REPE or REPZ (F3h)—This version of REP prefix repeats its associated string instruction the number of times specified in the counter register (rCX). Repetition stops when the value in rCX reaches 0 or when the zero flag (ZF) is cleared to 0. The prefix can only be used with the CMPSx and SCASx instructions.
- REPNE or REPNZ (F2h)—The REPNE or REPNZ prefix repeats its associated string instruction the number of times specified in the counter register (rCX). Repetition stops when the value in rCX reaches 0 or when the zero flag (ZF) is set to 1. The prefix can only be used with the CMPSx and SCASx instructions.

The size of the rCX counter is determined by the effective *address size*. For further details about these prefixes, including optimization of their use, see “Repeat Prefixes” in Volume 3.

3.5.2 REX Prefixes

REX prefixes are a new group of instruction-prefix bytes that can be used only in 64-bit mode. They enable the 64-bit register extensions. REX prefixes specify the following features:

- Use of an extended GPR register, shown in Figure 3-3 on page 31.
- Use of an extended XMM register, shown in Figure 4-12 on page 144.

- Use of a 64-bit (quadword) operand size, as described in “Operands” on page 42.
- Use of extended control and debug registers, as described in Volume 2.

REX prefix bytes have a value in the range 40h to 4Fh, depending on the particular combination of register extensions desired. With few exceptions, a REX prefix is required to access a 64-bit GPR or one of the extended GPR or XMM registers. A few instructions (described in “General-Purpose Instructions in 64-Bit Mode” in Volume 3) default to 64-bit operand size and do not need the REX prefix to access an extended 64-bit GPR.

An instruction can have only one REX prefix, and one such prefix is all that is needed to express the full selection of 64-bit-mode register-extension features. The prefix, if used, must immediately precede the first opcode byte of an instruction. Any other placement of a REX prefix is ignored. The legacy instruction-size limit of 15 bytes still applies to instructions that contain a REX prefix.

For further details on the REX prefixes, see “REX Prefixes” in Volume 3.

3.6 Feature Detection

The CUID instruction provides information about the processor implementation and its capabilities. Software operating at any privilege level can execute the CUID instruction to collect this information. After the information is collected, software can select procedures that optimize performance for a particular hardware implementation. For example, application software can determine whether the AMD64 architecture’s long mode is supported by the processor, and it can determine the processor implementation’s performance capabilities.

Support for the CUID instruction is implementation-dependent, as determined by software’s ability to write the RFLAGS.ID bit. The following code sample shows how to test for the presence of the CUID instruction.

```
pushfd                ; save EFLAGS
pop      eax          ; store EFLAGS in EAX
mov      ebx, eax     ; save in EBX for later testing
xor      eax, 00200000h ; toggle bit 21
push     eax          ; push to stack
popfd                ; save changed EAX to EFLAGS
pushfd                ; push EFLAGS to TOS
pop      eax          ; store EFLAGS in EAX
cmp      eax, ebx     ; see if bit 21 has changed
jz      NO_CPUID     ; if no change, no CPUID
```

After software has determined that the processor implementation supports the CPUID instruction, software can test for support of specific features by loading a function code (value) into the EAX register and executing the CPUID instruction. Processor feature information is returned in the EAX, EBX, ECX, and EDX registers, as described fully in “CPUID” in Volume 3.

The architecture supports CPUID information about *standard functions* and *extended functions*. In general, standard functions include the earliest features offered in the x86 architecture. Extended functions include newer features of the x86 and AMD64 architectures, such as SSE, SSE2, SSE3, and 3DNow! instructions, and long mode.

Standard functions are accessed by loading EAX with the value 0 (standard-function 0) or 1 (standard-function 1) and executing the CPUID instruction. All software using the CPUID instruction must execute standard-function 0, which identifies the processor vendor and the largest standard-function input value supported by the processor implementation. The CPUID standard-function 1 returns the processor version and standard-feature bits.

Software can test for support of extended functions by first executing the CPUID instruction with the value 8000_0000h in EAX. The processor returns, in EAX, the largest extended-function input value defined for the CPUID instruction on the processor implementation. If the value in EAX is greater than 8000_0000h, extended functions are supported, although specific extended functions must be tested individually.

The following code sample shows how to test for support of any extended functions:

```
mov    eax, 80000000h    ; query for extended functions
CPUID                                ; get extended function limit
cmp    eax, 80000000h    ; is EAX greater than 80000000?
jbe    NO_EXTENDEDMSR   ; no extended-feature support
```

If extended functions are supported, software can test for support of specific extended features. For example, software can determine whether the processor implementation supports long mode by executing the CPUID instruction with extended 8000_0001h in the EAX register, then testing to see if bit 29 in the EDX register is set to 1. The following code sample shows how to test for long-mode support.

```
mov    eax, 80000001h    ; query for function 8000_0001h
CPUID                                ; get feature bits in EDX
test   edx, 20000000h    ; test bit 29 in EDX
jnz    YES_Long_Mode     ; long mode is supported
```

With a few exceptions, general-purpose instructions are supported in all hardware implementations of the AMD64 architecture. Exceptional instructions are implemented only if their associated CPUID function bit is set. The implementation of certain media instructions (such as FXSAVE and FXRSTOR) and system instructions (such as RDMSR and WRMSR) is also indicated by CPUID function bits. See “CPUID” in the *AMD64 Architecture Programmer’s Manual Volume 3: General Purpose and System Instructions*, order# 24594, and the *AMD Processor Recognition Application Note*, order# 20734, for a full description of the CPUID instruction, all CPUID standard and extended functions, and the proper interpretation of returned values.

3.7 Control Transfers

3.7.1 Overview

From the application-program’s viewpoint, program-control flow is sequential—that is, instructions are addressed and executed sequentially—except when a branch instruction (a call, return, jump, interrupt, or return from interrupt) is encountered, in which case program flow changes to the branch instruction’s target address. Branches are used to iterate through loops and move through conditional program logic. Branches cause a new instruction pointer to be loaded into the rIP register, and sometimes cause the CS register to point to a different code segment. The CS:rIP values can be specified as

part of a branch instruction, or they can be read from a register or memory.

Branches can also be used to transfer control to another program or procedure running at a different privilege level. In such cases, the processor automatically checks the source program and target program privileges to ensure that the transfer is allowed before loading CS:rIP with the new values.

3.7.2 Privilege Levels

The processor's *protected* modes include legacy protected mode and long mode (both compatibility mode and 64-bit mode). In all protected modes and virtual x86 mode, privilege levels are used to isolate and protect programs and data from each other. The privilege levels are designated with a numerical value from 0 to 3, with 0 being the most privileged and 3 being the least privileged. Privilege 0 is normally reserved for critical system-software components that require direct access to, and control over, all processor and system resources. Privilege 3 is used by application software. The intermediate privilege levels (1 and 2) are used, for example, by device drivers and library routines that access and control a limited set of processor and system resources.

Figure 3-9 on page 95 shows the relationship of the four privilege-levels to each other. The protection scheme is implemented using the segmented memory-management mechanism described in “Segmented Virtual Memory” in Volume 2.

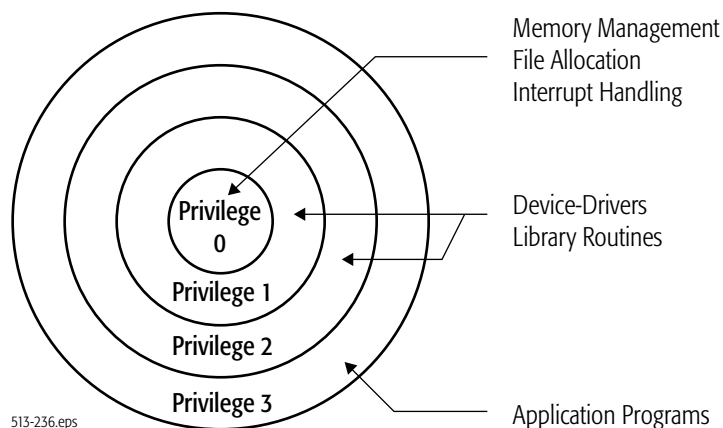

Figure 3-9. Privilege-Level Relationships

3.7.3 Procedure Stack

A procedure stack is often used by control transfer operations, particularly those that change privilege levels. Information from the calling program is passed to the target program on the procedure stack. CALL instructions, interrupts, and exceptions all push information onto the procedure stack. The pushed information includes a return pointer to the calling program and, for call instructions, optionally includes parameters. When a privilege-level change occurs, the calling program's stack pointer (the pointer to the top of the stack) is pushed onto the stack. Interrupts and exceptions also push a copy of the calling program's rFLAGS register and, in some cases, an error code associated with the interrupt or exception.

The RET or IRET control-transfer instructions reverse the operation of CALLs, interrupts, and exceptions. These return instructions pop the return pointer off the stack and transfer control back to the calling program. If the calling program's stack pointer was pushed, it is restored by popping the saved values off the stack and into the SS and rSP registers.

Stack Alignment. Control-transfer performance can degrade significantly when the stack pointer is not aligned properly. Stack pointers should be word aligned in 16-bit segments, doubleword aligned in 32-bit segments, and quadword aligned in 64-bit mode.

Stack Operand-Size in 64-Bit Mode. In 64-bit mode, the stack pointer size is always 64 bits. The stack size is not controlled by the default-size (B) bit in the SS descriptor, as it is in compatibility and legacy modes, nor can it be overridden by an instruction prefix. Address-size overrides are ignored for implicit stack references.

Except for far branches, all instructions that implicitly reference the stack pointer default to 64-bit operand size in 64-bit mode. Table 3-8 on page 98 lists these instructions.

The default 64-bit operand size eliminates the need for a REX prefix with these instructions. However, a REX prefix is still required if R8–R15 (the extended set of eight GPRs) are used as operands, because the prefix is required to address the extended registers. Pushes and pops of 32-bit stack values are not possible in 64-bit mode with these instructions, because there is no 32-bit operand-size override prefix for 64-bit mode.

3.7.4 Jumps

Jump instructions provide a simple means for transferring program control from one location to another. Jumps do not affect the procedure stack, and return instructions cannot transfer control back to the instruction following a jump. Two general types of jump instruction are available: unconditional (JMP) and conditional (Jcc).

There are two types of unconditional jumps (JMP):

- *Near Jumps*—When the target address is within the current code segment.
- *Far Jumps*—When the target address is outside the current code segment.

Although unconditional jumps can be used to change code segments, they cannot be used to change privilege levels.

Conditional jumps (Jcc) test the state of various bits in the rFLAGS register (or rCX) and jump to a target location based on the results of that test. Only near forms of conditional jumps are available, so Jcc cannot be used to transfer control to another code segment.

Table 3-8. Instructions that Implicitly Reference RSP in 64-Bit Mode

Mnemonic	Opcode (hex)	Description	Operand Size (bits)	
			Default	Possible Overrides ¹
CALL	E8, FF /2	Call Procedure Near	64	16
ENTER	C8	Create Procedure Stack Frame		
LEAVE	C9	Delete Procedure Stack Frame		
POP reg/mem	8F /0	Pop Stack (register or memory)		
POP reg	58 to 5F	Pop Stack (register)		
POP FS	0F A1	Pop Stack into FS Segment Register		
POP GS	0F A9	Pop Stack into GS Segment Register		
POPF POPQ	9D	Pop to EFLAGS Word or Quadword		
PUSH imm32	68	Push onto Stack (sign-extended doubleword)		
PUSH imm8	6A	Push onto Stack (sign-extended byte)		
PUSH reg/mem	FF /6	Push onto Stack (register or memory)		
PUSH reg	50–57	Push onto Stack (register)		
PUSH FS	0F A0	Push FS Segment Register onto Stack		
PUSH GS	0F A8	Push GS Segment Register onto Stack		
PUSHF PUSHFQ	9C	Push rFLAGS Word or Quadword onto Stack		
RET	C2, C3	Return From Call (near)		

Note:
1. There is no 32-bit operand-size override prefix in 64-bit mode.

3.7.5 Procedure Calls

The CALL instruction transfers control unconditionally to a new address, but unlike jump instructions, it saves a return pointer (CS:rIP) on the stack. The called procedure can use the RET instruction to pop the return pointers to the calling procedure from the stack and continue execution with the instruction following the CALL.

There are four types of CALL:

- *Near Call*—When the target address is within the current code segment.
- *Far Call*—When the target address is outside the current code segment.
- *Interprivilege-Level Far Call*—A far call that changes privilege level.
- *Task Switch*—A call to a target address in another task.

Near Call. When a near CALL is executed, only the calling procedure's rIP (the return offset) is pushed onto the stack. After the rIP is pushed, control is transferred to the new rIP value specified by the CALL instruction. Parameters can be pushed onto the stack by the calling procedure prior to executing the CALL instruction. Figure 3-10 shows the stack pointer before (old rSP value) and after (new rSP value) the CALL. The stack segment (SS) is not changed.

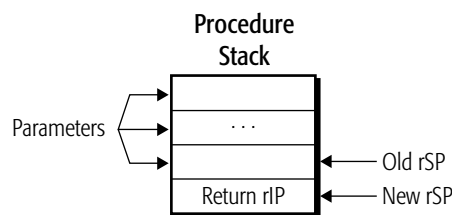

513-175.eps

Figure 3-10. Procedure Stack, Near Call

Far Call, Same Privilege. A far CALL changes the code segment, so the full return pointer (CS:rIP) is pushed onto the stack. After the return pointer is pushed, control is transferred to the new CS:rIP value specified by the CALL instruction. Parameters can be pushed onto the stack by the calling procedure prior to executing the CALL instruction. Figure 3-11 on page 100 shows the stack pointer before (old rSP value) and after (new rSP value) the CALL. The stack segment (SS) is not changed.

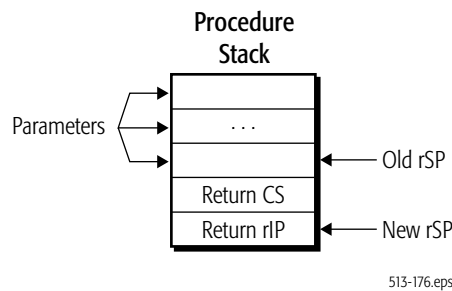

Figure 3-11. Procedure Stack, Far Call to Same Privilege

Far Call, Greater Privilege. A far CALL to a more-privileged procedure performs a stack switch prior to transferring control to the called procedure. Switching stacks isolates the more-privileged procedure’s stack from the less-privileged procedure’s stack, and it provides a mechanism for saving the return pointer back to the procedure that initiated the call.

Calls to more-privileged software can only take place through a system descriptor called a *call-gate descriptor*. Call-gate descriptors are created and maintained by system software. In 64-bit mode, only indirect far calls (those whose target memory address is in a register or other memory location) are supported. Absolute far calls (those that reference the base of the code segment) are not supported in 64-bit mode.

When a call to a more-privileged procedure occurs, the processor locates the new procedure’s stack pointer from its task-state segment (TSS). The old stack pointer (SS:rSP) is pushed onto the new stack, and (in legacy mode only) any parameters specified by the count field in the call-gate descriptor are copied from the old stack to the new stack (long mode does not support this automatic parameter copying). The return pointer (CS:rIP) is then pushed, and control is transferred to the new procedure. Figure 3-12 on page 101 shows an example of a stack switch resulting from a call to a more-privileged procedure. “Segmented Virtual Memory” in Volume 2 provides additional information on privilege-changing CALLs.

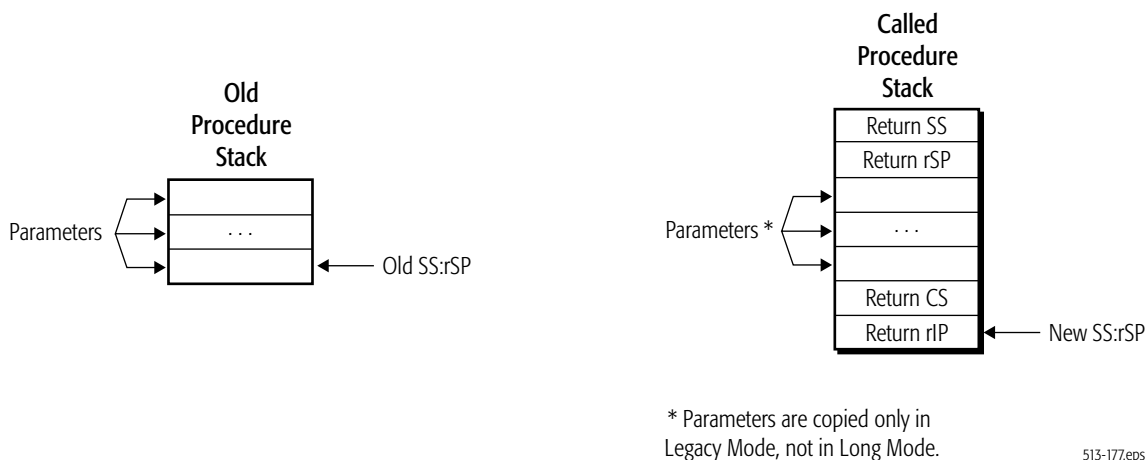

Figure 3-12. Procedure Stack, Far Call to Greater Privilege

Task Switch. In legacy mode, when a call to a new task occurs, the processor suspends the currently-executing task and stores the processor-state information at the point of suspension in the current task’s task-state segment (TSS). The new task’s state information is loaded from its TSS, and the processor resumes execution within the new task.

In long mode, hardware task switching is disabled. Task switching is fully described in “Segmented Virtual Memory” in Volume 2.

3.7.6 Returning from Procedures

The RET instruction reverses the effect of a CALL instruction. The return address is popped off the procedure stack, transferring control unconditionally back to the calling procedure at the instruction following the CALL. A return that changes privilege levels also switches stacks.

The three types of RET are:

- *Near Return*—Transfers control back to the calling procedure within the current code segment.
- *Far Return*—Transfers control back to the calling procedure outside the current code segment.
- *Interprivilege-Level Far Return*—A far return that changes privilege levels.

All of the RET instruction types can be used with an immediate operand indicating the number of parameter bytes present on the stack. These parameters are *released* from the stack—that is, the stack pointer is adjusted by the value of the immediate operand—but the parameter bytes are not actually popped off of the stack (i.e., read into a register or memory location).

Near Return. When a near RET is executed, the calling procedure's return offset is popped off of the stack and into the rIP register. Execution begins from the newly-loaded offset. If an immediate operand is included with the RET instruction, the stack pointer is adjusted by the number of bytes indicated. Figure 3-13 shows the stack pointer before (old rSP value) and after (new rSP value) the RET. The stack segment (SS) is not changed.

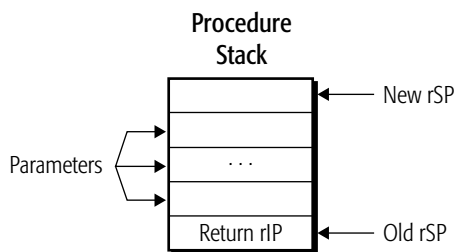

513-178.eps

Figure 3-13. Procedure Stack, Near Return

Far Return, Same Privilege. A far RET changes the code segment, so the full return pointer is popped off the stack and into the CS and rIP registers. Execution begins from the newly-loaded segment and offset. If an immediate operand is included with the RET instruction, the stack pointer is adjusted by the number of bytes indicated. Figure 3-14 on page 103 shows the stack pointer before (old rSP value) and after (new rSP value) the RET. The stack segment (SS) is not changed.

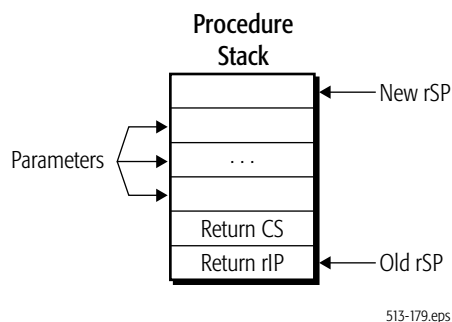

Figure 3-14. Procedure Stack, Far Return from Same Privilege

Far Return, Less Privilege. Privilege-changing far RETs can only return to less-privileged code segments, otherwise a general-protection exception occurs. The full return pointer is popped off the stack and into the CS and rIP registers, and execution begins from the newly-loaded segment and offset. A far RET that changes privilege levels also switches stacks. The return procedure's stack pointer is popped off the stack and into the SS and rSP registers. If an immediate operand is included with the RET instruction, the newly-loaded stack pointer is adjusted by the number of bytes indicated. Figure 3-15 shows the stack pointer before (old SS:rSP value) and after (new SS:rSP value) the RET. “Segmented Virtual Memory” in Volume 2 provides additional information on privilege-changing RETs.

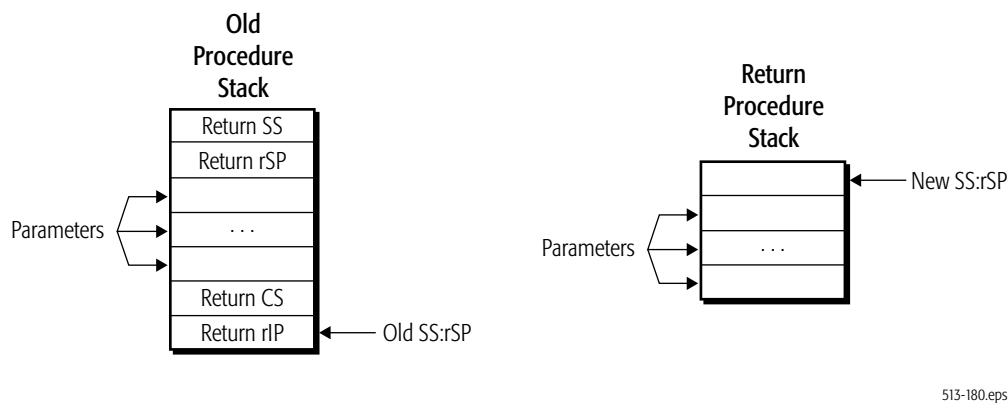

Figure 3-15. Procedure Stack, Far Return from Less Privilege

3.7.7 System Calls

A disadvantage of far CALLs and far RETs is that they use segment-based protection and privilege-checking. This involves significant overhead associated with loading new segment selectors and their corresponding descriptors into the segment registers. The overhead includes not only the time required to load the descriptors from memory but also the time required to perform the privilege, type, and limit checks. Privilege-changing CALLs to the operating system are slowed further by the control transfer through a gate descriptor.

SYSCALL and SYSRET. SYSCALL and SYSRET are low-latency system-call and system-return control-transfer instructions. They can be used in protected mode. These instructions eliminate segment-based privilege checking by using predetermined target and return code segments and stack segments. The operating system sets up and maintains the predetermined segments using special registers within the processor, so the segment descriptors do not need to be fetched from memory when the instructions are used. The simplifications made to privilege checking allow SYSCALL and SYSRET to complete in far fewer processor clock cycles than CALL and RET.

SYSRET can only be used to return from CPL = 0 procedures and is not available to application software. SYSCALL can be used by applications to call operating system service routines running at CPL = 0. The SYSCALL instruction does not take operands. Linkage conventions are initialized and maintained by the operating system. “System-Management Instructions” in Volume 2 contains detailed information on the operation of SYSCALL and SYSRET.

SYSENTER and SYSEXIT. The SYSENTER and SYSEXIT instructions provide similar capabilities to SYSCALL and SYSRET. However, these instructions can be used only in legacy mode and are not supported in long mode. SYSCALL and SYSRET are the preferred instructions for calling privileged software. See “System-Management Instructions” in Volume 2 for further information on SYSENTER and SYSEXIT.

3.7.8 General Considerations for Branching

Branching causes delays which are a function of the hardware-implementation’s branch-prediction capabilities. Sequential flow avoids the delays caused by branching but is still exposed to delays caused by cache misses, memory bus bandwidth, and other factors.

In general, branching code should be replaced with sequential code whenever practical. This is especially important if the branch body is small (resulting in frequent branching) and when branches depend on random data (resulting in frequent mispredictions of the branch target). In certain hardware implementations, far branches (as opposed to near branches) may not be predictable by the hardware, and recursive functions (those that call themselves) may overflow a return-address stack.

All calls and returns should be paired for optimal performance. Hardware implementations that include a return-address stack can lose stack synchronization if calls and returns are not paired.

3.7.9 Branching in 64-Bit Mode

Near Branches in 64-Bit Mode. The long-mode architecture expands the near-branch mechanisms to accommodate branches in the full 64-bit virtual-address space. In 64-bit mode, the operand size for all near branches defaults to 64 bits, so these instructions update the full 64-bit RIP.

Table 3-9 lists the near-branch instructions.

Table 3-9. Near Branches in 64-Bit Mode

Mnemonic	Opcode (hex)	Description	Operand Size (bits)	
			Default	Possible Overrides ¹
CALL	E8, FF /2	Call Procedure Near	64	16
Jcc	70 to 7F, 0F 80 to 0F 8F	Jump Conditional		
JCXZ JECXZ JRCXZ	E3	Jump on CX/ECX/RCX Zero		
JMP	EB, E9, FF /4	Jump Near		
LOOP	E2	Loop		
LOOPcc	E0, E1	Loop if Zero/Equal or Not Zero/Equal		
RET	C2, C3	Return From Call (near)		

Note:

1. There is no 32-bit operand-size override prefix in 64-bit mode.

The default 64-bit operand size eliminates the need for a REX prefix with these instructions when registers RAX–RSP (the first set of eight GPRs) are used as operands. A REX prefix is still required if R8–R15 (the extended set of eight GPRs) are used as operands, because the prefix is required to address the extended registers.

The following aspects of near branches are controlled by the effective operand size:

- Truncation of the instruction pointer.
- Size of a stack pop or push, resulting from a CALL or RET.
- Size of a stack-pointer increment or decrement, resulting from a CALL or RET.
- Indirect-branch operand size.

In 64-bit mode, all of the above actions are forced to 64 bits. However, the size of the displacement field for relative branches is still limited to 32 bits.

The operand size of near branches is fixed at 64 bits without the need for a REX prefix. However, the address size of near branches is not forced in 64-bit mode. Such addresses are 64 bits by default, but they can be overridden to 32 bits by a prefix.

Branches to 64-Bit Offsets. Because immediates are generally limited to 32 bits, the only way a full 64-bit absolute RIP can be specified in 64-bit mode is with an indirect branch. For this reason, direct forms of far branches are invalid in 64-bit mode.

3.7.10 Interrupts and Exceptions

Interrupts and exceptions are a form of control transfer operation. They are used to call special system-service routines, called interrupt handlers, which are designed to respond to the interrupt or exception condition. Pointers to the interrupt handlers are stored by the operating system in an *interrupt-descriptor table*, or IDT. In legacy real mode, the IDT contains an array of 4-byte far pointers to interrupt handlers. In legacy protected mode, the IDT contains an array of 8-byte gate descriptors. In long mode, the gate descriptors are 16 bytes. Interrupt gates, task gates, and trap gates can be stored in the IDT, but not call gates.

Interrupt handlers are usually privileged software because they typically require access to restricted system resources. System software is responsible for creating the interrupt gates and

storing them in the IDT. “Exceptions and Interrupts” in Volume 2 contains detailed information on the interrupt mechanism and the requirements on system software for managing the mechanism.

The IDT is indexed using the interrupt number, or *vector*. How the vector is specified depends on the source, as described below. The first 32 of the available 256 interrupt vectors are reserved for internal use by the processor—for exceptions (as described below) and other purposes.

Interrupts are caused either by software or hardware. The INT, INT3, and INTO instructions implement a *software interrupt* by calling an interrupt handler directly. These are general-purpose (privilege-level-3) instructions. The operand of the INT instruction is an immediate byte value specifying the interrupt vector used to index the IDT. INT3 and INTO are specific forms of software interrupts used to call interrupt 3 and interrupt 4, respectively. *External interrupts* are produced by system logic which passes the IDT index to the processor via input signals. External interrupts can be either *maskable* or *non-maskable*.

Exceptions usually occur as a result of software execution errors or other internal-processor errors. Exceptions can also occur in non-error situations, such as debug-program single-stepping or address-breakpoint detection. In the case of exceptions, the processor produces the IDT index based on the detected condition. The handlers for interrupts and exceptions are identical for a given vector.

The processor’s response to an exception depends on the type of the exception. For all exceptions except 128-bit-media and x87 floating-point exceptions, control automatically transfers to the handler (or service routine) for that exception, as defined by the exceptions vector. For 128-bit-media and x87 floating-point exceptions, there is both a masked and unmasked response. When unmasked, these exceptions invoke their exception handler. When masked, a default masked response is provided instead of invoking the exception handler.

Exceptions and software-initiated interrupts occur synchronously with respect to the processor clock. There are three types of exceptions:

- *Faults*—A fault is a precise exception that is reported on the boundary before the interrupted instruction. Generally,

faults are caused by an undesirable error condition involving the interrupted instruction, although some faults (such as page faults) are common and normal occurrences. After the service routine completes, the machine state prior to the faulting instruction is restored, and the instruction is retried.

- *Traps*—A trap is a precise exception that is reported on the boundary following the interrupted instruction. The instruction causing the exception finishes before the service routine is invoked. Software interrupts and certain breakpoint exceptions used in debugging are traps.
- *Aborts*—Aborts are imprecise exceptions. The instruction causing the exception, and possibly an indeterminate additional number of instructions, complete execution before the service routine is invoked. Because they are imprecise, aborts typically do not allow reliable program restart.

Table 3-10 shows the interrupts and exceptions that can occur, together with their vector numbers, mnemonics, source, and causes. For a detailed description of interrupts and exceptions, see “Exceptions and Interrupts” in Volume 2.

Control transfers to interrupt handlers are similar to far calls, except that for the former, the rFLAGS register is pushed onto the stack before the return address. Interrupts and exceptions to several of the first 32 interrupts can also push an error code onto the stack. No parameters are passed by an interrupt. As with CALLs, interrupts that cause a privilege change also perform a stack switch.

Table 3-10. Interrupts and Exceptions

Vector	Interrupt (Exception)	Mnemonic	Source	Cause	Generated By General-Purpose Instructions
0	Divide-By-Zero-Error	#DE	Software	DIV, IDIV instructions	yes
1	Debug	#DB	Internal	Instruction accesses and data accesses	yes
2	Non-Maskable-Interrupt	NMI	External	External $\overline{\text{NMI}}$ signal	no
3	Breakpoint	#BP	Software	INT3 instruction	yes

Table 3-10. Interrupts and Exceptions (continued)

Vector	Interrupt (Exception)	Mnemonic	Source	Cause	Generated By General-Purpose Instructions
4	Overflow	#OF	Software	INTO instruction	yes
5	Bound-Range	#BR	Software	BOUND instruction	yes
6	Invalid-Opcode	#UD	Internal	Invalid instructions	yes
7	Device-Not-Available	#NM	Internal	x87 instructions	no
8	Double-Fault	#DF	Internal	Interrupt during an interrupt	yes
9	Coprocessor-Segment-Overrun	—	External	Unsupported (reserved)	
10	Invalid-TSS	#TS	Internal	Task-state segment access and task switch	yes
11	Segment-Not-Present	#NP	Internal	Segment access through a descriptor	yes
12	Stack	#SS	Internal	SS register loads and stack references	yes
13	General-Protection	#GP	Internal	Memory accesses and protection checks	yes
14	Page-Fault	#PF	Internal	Memory accesses when paging enabled	yes
15	Reserved	—			
16	x87 Floating-Point Exception-Pending	#MF	Software	x87 floating-point and 64-bit media floating-point instructions	no
17	Alignment-Check	#AC	Internal	Memory accesses	yes
18	Machine-Check	#MC	Internal External	Model specific	yes
19	SIMD Floating-Point	#XF	Internal	128-bit media floating-point instructions	no

Table 3-10. Interrupts and Exceptions (continued)

Vector	Interrupt (Exception)	Mnemonic	Source	Cause	Generated By General-Purpose Instructions	
20–31	Reserved (Internal and External)	—				
32–255	External Interrupts (Maskable)	—	External	External interrupt signalling	no	
0–255	Software Interrupts	—	Software	INT instruction	yes	

Interrupt to Same Privilege in Legacy Mode. When an interrupt to a handler running at the same privilege occurs, the processor pushes a copy of the rFLAGS register, followed by the return pointer (CS:rIP), onto the stack. If the interrupt generates an error code, it is pushed onto the stack as the last item. Control is then transferred to the interrupt handler. Figure 3-16 shows the stack pointer before (old rSP value) and after (new rSP value) the interrupt. The stack segment (SS) is not changed.

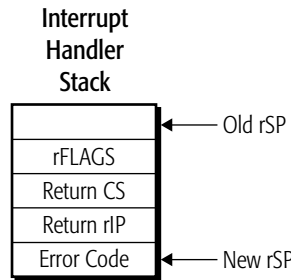

513-182.eps

Figure 3-16. Procedure Stack, Interrupt to Same Privilege

Interrupt to More Privilege or in Long Mode. When an interrupt to a more-privileged handler occurs or the processor is operating in long mode the processor locates the handler’s stack pointer from the TSS. The old stack pointer (SS:rSP) is pushed onto the new stack, along with a copy of the rFLAGS register. The return pointer (CS:rIP) to the interrupted program is then copied to the stack. If the interrupt generates an error code, it is pushed

onto the stack as the last item. Control is then transferred to the interrupt handler. Figure 3-17 shows an example of a stack switch resulting from an interrupt with a change in privilege.

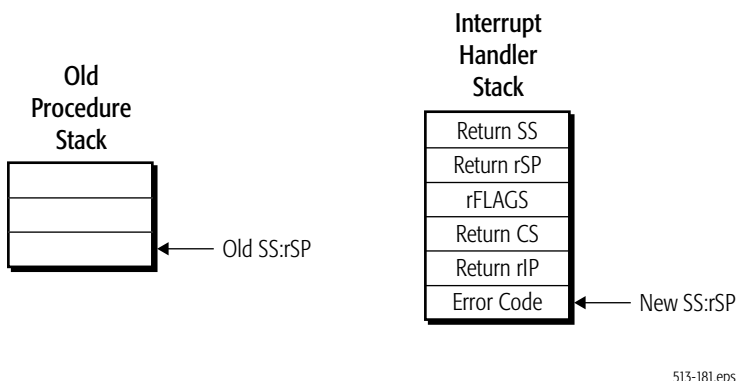

Figure 3-17. Procedure Stack, Interrupt to Higher Privilege

Interrupt Returns. The IRET, IRETD, and IRETQ instructions are used to return from an interrupt handler. Prior to executing an IRET, the interrupt handler must pop the error code off of the stack if one was pushed by the interrupt or exception. IRET restores the interrupted program's rIP, CS, and rFLAGS by popping their saved values off of the stack and into their respective registers. If a privilege change occurs or IRET is executed in 64-bit mode, the interrupted program's stack pointer (SS:rSP) is also popped off of the stack. Control is then transferred back to the interrupted program.

3.8 Input/Output

I/O devices allow the processor to communicate with the outside world, usually to a human or to another system. In fact, a system without I/O has little utility. Typical I/O devices include a keyboard, mouse, LAN connection, printer, storage devices, and monitor. The speeds these devices must operate at vary greatly, and usually depend on whether the communication is to a human (slow) or to another machine (fast). There are exceptions. For example, humans can consume graphics data at very high rates.

There are two methods for communicating with I/O devices in AMD64 processor implementations. One method involves accessing I/O through ports located in I/O-address space (“I/O Addressing” on page 112), and the other method involves accessing I/O devices located in the memory-address space (“Memory Organization” on page 11). The address spaces are separate and independent of each other.

I/O-address space was originally introduced as an optimized means for accessing I/O-device control ports. Then, systems usually had few I/O devices, devices tended to be relatively low-speed, device accesses needed to be strongly ordered to guarantee proper operation, and device protection requirements were minimal or non-existent. Memory-mapped I/O has largely supplanted I/O-address space access as the preferred means for modern operating systems to interface with I/O devices. Memory-mapped I/O offers greater flexibility in protection, vastly more I/O ports, higher speeds, and strong or weak ordering to suit the device requirements.

3.8.1 I/O Addressing

Access to I/O-address space is provided by the IN and OUT instructions, and the string variants of these instructions, INS and OUTS. The operation of these instructions are described in “Input/Output” on page 77. Although not required, processor implementations generally transmit I/O-port addresses and I/O data over the same external signals used for memory addressing and memory data. Different bus-cycles generated by the processor differentiate I/O-address space accesses from memory-address space accesses.

I/O-Address Space. Figure 3-18 on page 113 shows the 64 Kbyte I/O-address space. I/O ports can be addressed as bytes, words, or doublewords. As with memory addressing, word-I/O and doubleword-I/O ports are simply two or four consecutively-addressed byte-I/O ports. Word and doubleword I/O ports can be aligned on any byte boundary, but there is typically a performance penalty for unaligned accesses. Performance is optimized by aligning word-I/O ports on word boundaries, and doubleword-I/O ports on doubleword boundaries.

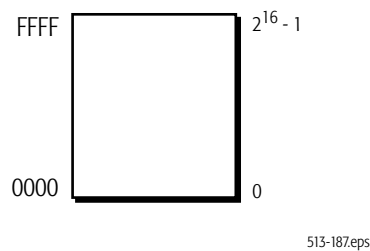

Figure 3-18. I/O Address Space

Memory-Mapped I/O. Memory-mapped I/O devices are attached to the system memory bus and respond to memory transactions as if they were memory devices, such as DRAM. Access to memory-mapped I/O devices can be performed using any instruction that accesses memory, but typically MOV instructions are used to transfer data between the processor and the device. Some I/O devices may have restrictions on read-modify-write accesses.

Any location in memory can be used as a memory-mapped I/O address. System software can use the paging facilities to virtualize memory devices and protect them from unauthorized access. See “System-Management Instructions” in Volume 2 for a discussion of memory virtualization and paging.

3.8.2 I/O Ordering

The order of read and write accesses between the processor and an I/O device is usually important for properly controlling device operation. Accesses to I/O-address space and memory-address space differ in the default ordering enforced by the processor and the ability of software to control ordering.

I/O-Address Space. The processor always orders I/O-address space operations strongly, with respect to other I/O and memory operations. Software cannot modify the I/O ordering enforced by the processor. IN instructions are not executed until all previous writes to I/O space and memory have completed. OUT instructions delay execution of the *following* instruction until all writes—including the write performed by the OUT—have completed. Unlike memory writes, writes to I/O addresses are never buffered by the processor.

The processor can use more than one bus transaction to access an unaligned, multi-byte I/O port. Unaligned accesses to I/O-address space do not have a defined bus transaction ordering,

and that ordering can change from one implementation to another. If the use of an unaligned I/O port is required, and the order of bus transactions to that port is important, software should decompose the access into multiple, smaller aligned accesses.

Memory-Mapped I/O. To maximize software performance, processor implementations can execute instructions out of program order. This can cause the sequence of memory accesses to also be out of program order, called *weakly ordered*. As described in “Accessing Memory” on page 115, the processor can perform memory reads in any order, it can perform reads without knowing whether it requires the result (speculation), and it can reorder reads ahead of writes. In the case of writes, multiple writes to memory locations in close proximity to each other can be combined into a single write or a burst of multiple writes. Writes can also be delayed, or buffered, by the processor.

Application software that needs to force memory ordering to memory-mapped I/O devices can do so using the read/write barrier instructions: LFENCE, SFENCE, and MFENCE. These instructions are described in “Forcing Memory Order” on page 117. Serializing instructions, I/O instructions, and locked instructions can also be used as read/write barriers, but they modify program state and are an inferior method for enforcing strong-memory ordering.

Typically, the operating system controls access to memory-mapped I/O devices. The AMD64 architecture provides facilities for system software to specify the types of accesses and their ordering for entire regions of memory. These facilities are also used to manage the cacheability of memory regions. See “System-Management Instructions” in Volume 2 for further information.

3.8.3 Protected-Mode I/O

In protected mode, access to the I/O-address space is governed by the I/O privilege level (IOPL) field in the rFLAGS register, and the I/O-permission bitmap in the current task-state segment (TSS).

I/O-Privilege Level. RFLAGS.IOPL governs access to *IOPL-sensitive* instructions. All of the I/O instructions (IN, INS, OUT, and OUTS) are IOPL-sensitive. IOPL-sensitive instructions cannot be executed by a program unless the program’s current-

privilege level (CPL) is numerically less (more privileged) than or equal to the RFLAGS.IOPL field, otherwise a general-protection exception (#GP) occurs.

Only software running at CPL = 0 can change the RFLAGS.IOPL field. Two instructions, POPF and IRET, can be used to change the field. If application software (or any software running at CPL > 0) attempts to change RFLAGS.IOPL, the attempt is ignored.

System software uses RFLAGS.IOPL to control the privilege level required to access I/O-address space devices. Access can be granted on a program-by-program basis using different copies of RFLAGS for every program, each with a different IOPL. RFLAGS.IOPL acts as a global control over a program's access to I/O-address space devices. System software can grant less-privileged programs access to individual I/O devices (overriding RFLAGS.IOPL) by using the I/O-permission bitmap stored in a program's TSS. For details about the I/O-permission bitmap, see "I/O-Permission Bitmap" in Volume 2.

3.9 Memory Optimization

Generally, application software is unaware of the memory hierarchy implemented within a particular system design. The application simply sees a homogenous address space within a single level of memory. In reality, both system and processor implementations can use any number of techniques to speed up accesses into memory, doing so in a manner that is transparent to applications. Application software can be written to maximize this speed-up even though the methods used by the hardware are not visible to the application. This section gives an overview of the memory hierarchy and access techniques that can be implemented within a system design, and how applications can optimize their use.

3.9.1 Accessing Memory

Implementations of the AMD64 architecture *commit* the results of each instruction—i.e., store the result of the executed instruction in software-visible resources, such as a register (including flags), the data cache, an internal write buffer, or memory—in program order, which is the order specified by the instruction sequence in a program. Transparent to the application, implementations can execute instructions in any order and temporarily hold out-of-order results until the

instructions are committed. Implementations can also *speculatively* execute instructions—executing instructions before knowing their results will be used (for example, executing both sides of a branch). By executing instructions out-of-order and speculatively, a processor can boost application performance by executing instructions that are ready, rather than delaying them behind instructions that are waiting for data. However, the processor commits results in program order (the order expected by software).

When executing instructions out-of-order and speculatively, processor implementations often find it useful to also allow out-of-order and speculative memory accesses. However, such memory accesses are potentially visible to software and system devices. The following sections describe the architectural rules for memory accesses. See “Memory System” in Volume 2 for information on how system software can further specify the flexibility of memory accesses.

Read Ordering. The ordering of memory reads does not usually affect program execution because the ordering does not usually affect the state of software-visible resources. The rules governing read ordering are:

- *Out-of-order reads are allowed.* Out-of-order reads can occur as a result of out-of-order instruction execution. The processor can read memory out-of-order to prevent stalling instructions that are executed out-of-order.
- *Speculative reads are allowed.* A speculative read occurs when the processor begins executing a memory-read instruction before it knows whether the instruction’s result will actually be needed. For example, the processor can predict a branch to occur and begin executing instructions following the predicted branch, before it knows whether the prediction is valid. When one of the speculative instructions reads data from memory, the read itself is speculative.
- *Reads can usually be reordered ahead of writes.* Reads are generally given a higher priority by the processor than writes because instruction execution stalls if the read data required by an instruction is not immediately available. Allowing reads ahead of writes usually maximizes software performance.

Reads can be reordered ahead of writes, except that a read *cannot* be reordered ahead of a prior write if the read is from

the same location as the prior write. In this case, the read instruction stalls until the write instruction is committed. This is because the result of the write instruction is required by the read instruction for software to operate correctly.

Some system devices might be sensitive to reads. Normally, applications do not have direct access to system devices, but instead call an operating-system service routine to perform the access on the application's behalf. In this case, it is system software's responsibility to enforce strong read-ordering.

Write Ordering. Writes affect program order because they affect the state of software-visible resources. The rules governing write ordering are restrictive:

- *Generally, out-of-order writes are not allowed.* Write instructions executed out-of-order cannot *commit* (write) their result to memory until all previous instructions have completed in program order. The processor can, however, hold the result of an out-of-order write instruction in a private buffer (not visible to software) until that result can be committed to memory.

System software can create non-cacheable *write-combining* regions in memory when the order of writes is known to not affect system devices. When writes are performed to write-combining memory, they can appear to complete out of order relative to other writes. See “Memory System” in Volume 2 for additional information.

- *Speculative writes are not allowed.* As with out-of-order writes, speculative write instructions cannot commit their result to memory until all previous instructions have completed in program order. Processors can hold the result in a private buffer (not visible to software) until the result can be committed.

3.9.2 Forcing Memory Order

Special instructions are provided for application software to force memory ordering in situations where such ordering is important. These instructions are:

- *Load Fence*—The LFENCE instruction forces ordering of memory loads (reads). All memory loads preceding the LFENCE (in program order) are completed prior to completing memory loads following the LFENCE. Memory loads cannot be reordered around an LFENCE instruction,

but other non-serializing instructions (such as memory writes) can be reordered around the LFENCE.

- *Store Fence*—The SFENCE instruction forces ordering of memory stores (writes). All memory stores preceding the SFENCE (in program order) are completed prior to completing memory stores following the SFENCE. Memory stores cannot be reordered around an SFENCE instruction, but other non-serializing instructions (such as memory loads) can be reordered around the SFENCE.
- *Memory Fence*—The MFENCE instruction forces ordering of all memory accesses (reads and writes). All memory accesses preceding the MFENCE (in program order) are completed prior to completing any memory access following the MFENCE. Memory accesses cannot be reordered around an MFENCE instruction, but other non-serializing instructions that do not access memory can be reordered around the MFENCE.

Although they serve different purposes, other instructions can be used as read/write barriers when the order of memory accesses must be strictly enforced. These read/write barrier instructions force all prior reads and writes to complete before subsequent reads or writes are executed. Unlike the fence instructions listed above, these other instructions alter the software-visible state. This makes these instructions less general and more difficult to use as read/write barriers than the fence instructions, although their use may reduce the total number of instructions executed. The following instructions are usable as read/write barriers:

- *Serializing instructions*—Serializing instructions force the processor to commit the serializing instruction and all previous instructions before the next instruction is fetched from memory. The serializing instructions available to applications are CPUID and IRET. A serializing instruction is committed when the following operations are complete:
 - The instruction has executed.
 - All registers modified by the instruction are updated.
 - All memory updates performed by the instruction are complete.
 - All data held in the write buffers have been written to memory. (Write buffers are described in “Write Buffering” on page 121).

- *I/O instructions*—Reads from and writes to I/O-address space use the IN and OUT instructions, respectively. When the processor executes an I/O instruction, it orders it with respect to other loads and stores, depending on the instruction:
 - IN instructions (IN, INS, and REP INS) are not executed until all previous stores to memory and I/O-address space are complete.
 - Instructions *following* an OUT instruction (OUT, OUTS, or REP OUTS) are not executed until all previous stores to memory and I/O-address space are complete, including the store performed by the OUT.
- *Locked instructions*—A locked instruction is one that contains the LOCK instruction prefix. A locked instruction is used to perform an atomic read-modify-write operation on a memory operand, so it needs exclusive access to the memory location for the duration of the operation. Locked instructions order memory accesses in the following way:
 - All previous loads and stores (in program order) are completed prior to executing the locked instruction.
 - The locked instruction is completed before allowing loads and stores for subsequent instructions (in program order) to occur.

Only certain instructions can be locked. See “Lock Prefix” in Volume 3 for a list of instructions that can use the LOCK prefix.

3.9.3 Caches

Depending on the instruction, operands can be encoded in the instruction opcode or located in registers, I/O ports, or memory locations. An operand that is located in memory can actually be physically present in one or more locations within a system’s *memory hierarchy*.

Memory Hierarchy. A system’s memory hierarchy may have some or all of the following levels:

- *Main Memory*—Main memory is external to the processor chip and is the memory-hierarchy level farthest from the processor’s execution units. All physical-memory addresses are present in main memory, which is implemented using relatively slow, but high-density memory devices.
- *External Caches*—External caches are external to the processor chip, but are implemented using lower-capacity, higher-performance memory devices than system memory.

The system uses external caches to hold copies of frequently-used instructions and data found in main memory. A subset of the physical-memory addresses can be present in the external caches at any time. A system can contain any number of external caches, or none at all.

- *Internal Caches*—Internal caches are present on the processor chip itself, and are the closest memory-hierarchy level to the processor’s execution units. Because of their presence on the processor chip, access to internal caches is very fast. Internal caches contain copies of the most frequently-used instructions and data found in main memory *and* external caches, and their capacities are relatively small in comparison to external caches. A processor implementation can contain any number of internal caches, or none at all. Implementations often contain a first-level instruction cache and first-level data (operand) cache, and they may also contain a higher-capacity (and slower) second-level internal cache for storing both instructions and data.

Figure 3-19 on page 121 shows an example of a four-level memory hierarchy that combines main memory, external third-level (L3) cache, and internal second-level (L2) and two first-level (L1) caches. As the figure shows, the first-level and second-level caches are implemented on the processor chip, and the third-level cache is external to the processor. The first-level cache is a split cache, with separate caches used for instructions and data. The second-level and third-level caches are unified (they contain both instructions and data). Memory at the highest levels of the hierarchy have greater capacity (larger size), but have slower access, than memory at the lowest levels.

Using caches to store frequently used instructions and data can result in significantly improved software performance by avoiding accesses to the slower main memory. Applications function identically on systems without caches and on systems with caches, although cacheless systems typically execute applications more slowly. Application software can, however, be optimized to make efficient use of caches when they are present, as described later in this section.

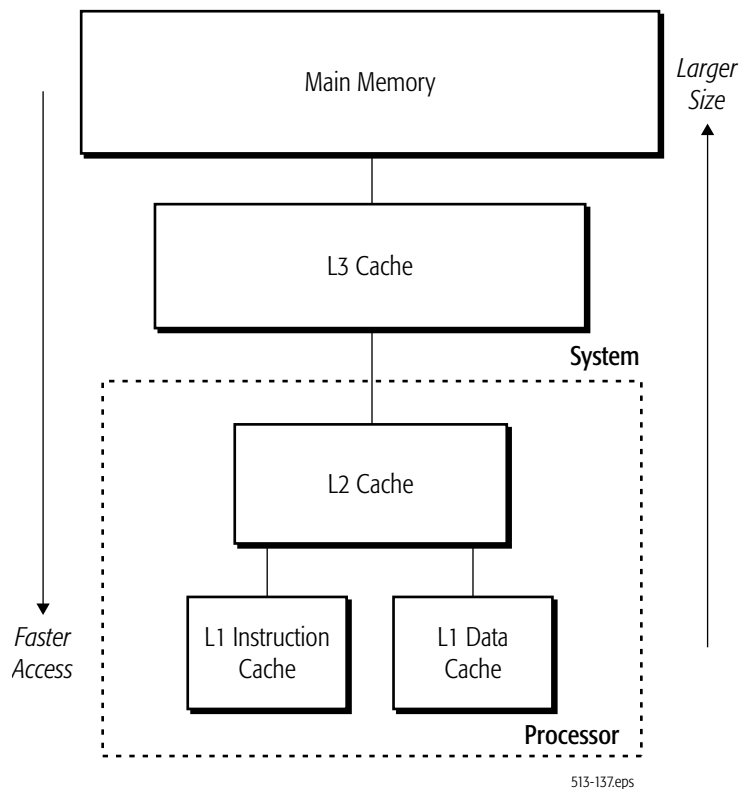

Figure 3-19. Memory Hierarchy Example

Write Buffering. Processor implementations can contain write-buffers attached to the internal caches. Write buffers can also be present on the interface used to communicate with the external portions of the memory hierarchy. Write buffers temporarily hold data writes when main memory or the caches are busy responding to other memory-system accesses. The existence of write buffers is transparent to software. However, some of the instructions used to optimize memory-hierarchy performance can affect the write buffers, as described in “Forcing Memory Order” on page 117.

3.9.4 Cache Operation

Although the existence of caches is transparent to application software, a simple understanding how caches are accessed can assist application developers in optimizing their code to run efficiently when caches are present.

Caches are divided into fixed-size blocks, called *cache lines*. Typically, implementations have either 32-byte or 64-byte cache lines. The processor *allocates* a cache line to correspond to an identically-sized region in main memory. After a cache line is allocated, the addresses in the corresponding region of main memory are used as addresses into the cache line. It is the processor's responsibility to keep the contents of the allocated cache line *coherent* with main memory. Should another system device access a memory address that is cached, the processor maintains coherency by providing the correct data back to the device and main memory.

When a memory-read occurs as a result of an instruction fetch or operand access, the processor first checks the cache to see if the requested information is available. A *read hit* occurs if the information is available in the cache, and a *read miss* occurs if the information is not available. Likewise, a *write hit* occurs if a memory write can be stored in the cache, and a *write miss* occurs if it cannot be stored in the cache.

A read miss or write miss can result in the allocation of a cache line, followed by a *cache-line fill*. Even if only a single byte is needed, all bytes in a cache line are loaded from memory by a cache-line fill. Typically, a cache-line fill must write over an existing cache line in a process called a *cache-line replacement*. In this case, if the existing cache line is modified, the processor performs a cache-line *writeback* to main memory prior to performing the cache-line fill.

Cache-line writebacks help maintain coherency between the caches and main memory. Internally, the processor can also maintain cache coherency by *internally probing* (checking) the other caches and write buffers for a more recent version of the requested data. External devices can also check a processor's caches and write buffers for more recent versions of data by *externally probing* the processor. All coherency operations are performed in hardware and are completely transparent to applications.

Cache Coherency and MOESI. Implementations of the AMD64 architecture maintain coherency between memory and caches using a five-state protocol known as MOESI. The five MOESI states are *modified*, *owned*, *exclusive*, *shared*, and *invalid*. See “Memory System” in Volume 2 for additional information on MOESI and cache coherency.

Self-Modifying Code. Software that writes into a code segment is classified as self-modifying code. To avoid cache-coherency problems due to self-modifying code, implementations of the AMD64 architecture invalidate an instruction cache line during a memory write if the instruction cache line corresponds to a code-segment memory location. By invalidating the instruction cache line, the processor is forced to write the modified instruction into main memory. A subsequent fetch of the modified instruction goes to main memory to get the coherent version of the instruction.

3.9.5 Cache Pollution

Because cache sizes are limited, caches should be filled only with data that is frequently used by an application. Data that is used infrequently, or not at all, is said to *pollute* the cache because it occupies otherwise useful cache lines. Ideally, the best data to cache is data that adheres to the *principle of locality*. This principle has two components: *temporal locality* and *spatial locality*.

- *Temporal locality* refers to data that is likely to be used more than once in a short period of time. It is useful to cache temporal data because subsequent accesses can retrieve the data quickly. Non-temporal data is assumed to be used once, and then not used again for a long period of time, or ever. Caching of non-temporal data pollutes the cache and should be avoided.

Cache-control instructions (“Cache-Control Instructions” on page 124) are available to applications to minimize cache pollution caused by non-temporal data.

- *Spatial locality* refers to data that resides at addresses adjacent to or very close to the data being referenced. Typically, when data is accessed, it is likely the data at nearby addresses will be accessed in a short period of time. Caches perform cache-line fills in order to take advantage of spatial locality. During a cache-line fill, the referenced data and nearest neighbors are loaded into the cache. If the characteristics of spacial locality do not fit the data used by an application, then the cache becomes polluted with a large amount of unreferenced data.

Applications can avoid problems with this type of cache pollution by using data structures with good spatial-locality characteristics.

Another form of cache pollution is *stale data*. Data that adheres to the principle of locality can become stale when it is no longer used by the program, or won't be used again for a long time. Applications can use the CLFLUSH instruction to remove stale data from the cache.

3.9.6 Cache-Control Instructions

General control and management of the caches is performed by system software and not application software. System software uses special registers to assign *memory types* to physical-address ranges, and page-attribute tables are used to assign memory types to virtual address ranges. Memory types define the cacheability characteristics of memory regions and how coherency is maintained with main memory. See “Memory System” in Volume 2 for additional information on memory typing.

Instructions are available that allow application software to control the cacheability of data it uses on a more limited basis. These instructions can be used to boost an application's performance by prefetching data into the cache, and by avoiding cache pollution. Run-time analysis tools and compilers may be able to suggest the use of cache-control instructions for critical sections of application code.

Cache Prefetching. Applications can prefetch entire cache lines into the caching hierarchy using one of the prefetch instructions. The prefetch should be performed in advance, so that the data is available in the cache when needed. Although load instructions can mimic the prefetch function, they do not offer the same performance advantage, because a load instruction may cause a subsequent instruction to stall until the load completes, but a prefetch instruction will never cause such a stall. Load instructions also unnecessarily require the use of a register, but prefetch instructions do not.

The instructions available in the AMD64 architecture for cache-line prefetching include one SSE instruction and two 3DNow! instructions:

- *PREFETCHlevel*—(an SSE instruction) Prefetches read/write data into a specific level of the cache hierarchy. If the requested data is already in the desired cache level or closer to the processor (lower cache-hierarchy level), the data is not prefetched. If the operand specifies an invalid memory address, no exception occurs, and the instruction has no effect. Attempts to prefetch data from non-cacheable

memory, such as video frame buffers, or data from write-combining memory, are also ignored. The exact actions performed by the *PREFETCHlevel* instructions depend on the processor implementation. Current AMD processor families map all *PREFETCHlevel* instructions to a *PREFETCH*. Refer to the *Optimization Guide for AMD Athlon™ 64 and AMD Opteron™ Processors*, order# 25112, for details relating to a particular processor family, brand or model.

- *PREFETCHT0*—Prefetches temporal data into the entire cache hierarchy.
 - *PREFETCHT1*—Prefetches temporal data into the second-level (L2) and higher-level caches, but not into the L1 cache.
 - *PREFETCHT2*—Prefetches temporal data into the third-level (L3) and higher-level caches, but not into the L1 or L2 cache.
 - *PREFETCHNTA*—Prefetches non-temporal data into the processor, minimizing cache pollution. The specific technique for minimizing cache pollution is implementation-dependent and can include such techniques as allocating space in a software-invisible buffer, allocating a cache line in a single cache or a specific way of a cache, etc.
- *PREFETCH*—(a 3DNow! instruction) Prefetches read data into the L1 data cache. Data can be written to such a cache line, but doing so can result in additional delay because the processor must signal externally to negotiate the right to change the cache line's cache-coherency state for the purpose of writing to it.
 - *PREFETCHW*—(a 3DNow! instruction) Prefetches write data into the L1 data cache. Data can be written to the cache line without additional delay, because the data is already prefetched in the *modified* cache-coherency state. Data can also be read from the cache line without additional delay. However, prefetching write data takes longer than prefetching read data if the processor must wait for another caching master to first write-back its modified copy of the requested data to memory before the prefetch request is satisfied.

The *PREFETCHW* instruction provides a hint to the processor that the cache line is to be modified, and is intended for use

when the cache line will be written to shortly after the prefetch is performed. The processor can place the cache line in the modified state when it is prefetched, but before it is actually written. Doing so can save time compared to a PREFETCH instruction, followed by a subsequent cache-state change due to a write.

To prevent a false-store dependency from stalling a prefetch instruction, prefetched data should be located at least one cache-line away from the address of any surrounding data write. For example, if the cache-line size is 32 bytes, avoid prefetching from data addresses within 32 bytes of the data address in a preceding write instruction.

Non-Temporal Stores. Non-temporal store instructions are provided to prevent memory writes from being stored in the cache, thereby reducing cache pollution. These non-temporal store instructions are specific to the type of register they write:

- *GPR Non-Temporal Stores*—MOVNTI.
- *XMM Non-Temporal Stores*—MASKMOVDQU, MOVNTDQ, MOVNTPD, and MOVNTPS.
- *MMX Non-Temporal Stores*—MASKMOVQ and MOVNTQ.

Removing Stale Cache Lines. When cache data becomes stale, it occupies space in the cache that could be used to store frequently-accessed data. Applications can use the CLFLUSH instruction to free a stale cache-line for use by other data. CLFLUSH writes the contents of a cache line to memory and then invalidates the line in the cache and in all other caches in the cache hierarchy that contain the line. Once invalidated, the line is available for use by the processor and can be filled with other data.

3.10 Performance Considerations

In addition to typical code optimization techniques, such as those affecting loops and the inlining of function calls, the following considerations may help improve the performance of application programs written with general-purpose instructions.

These are implementation-independent performance considerations. Other considerations depend on the hardware implementation. For information about such implementation-

dependent considerations and for more information about application performance in general, see the data sheets and the software-optimization guides relating to particular hardware implementations.

3.10.1 Use Large Operand Sizes

Loading, storing, and moving data with the largest relevant operand size maximizes the memory bandwidth of these instructions.

3.10.2 Use Short Instructions

Use the shortest possible form of an instruction (the form with fewest opcode bytes). This increases the number of instructions that can be decoded at any one time, and it reduces overall code size.

3.10.3 Align Data

Data alignment directly affects memory-access performance. Data alignment is particularly important when accessing *streaming* (also called *non-temporal*) data—data that will not be reused and therefore should not be cached. Data alignment is also important in cases where data that is written by one instruction is subsequently read by a subsequent instruction soon after the write.

3.10.4 Avoid Branches

Branching can be very time-consuming. If the body of a branch is small, the branch may be replaceable with conditional move (CMOV cc) instructions, or with 128-bit or 64-bit media instructions that simulate predicated parallel execution or parallel conditional moves.

3.10.5 Prefetch Data

Memory latency can be substantially reduced—especially for data that will be used multiple times—by prefetching such data into various levels of the cache hierarchy. Software can use the PREFETCH x instructions very effectively in such cases. One PREFETCH x per cache line should be used.

Some of the best places to use prefetch instructions are inside loops that process large amounts of data. If the loop goes through less than one cache line of data per iteration, partially unroll the loop. Try to use virtually all of the prefetched data. This usually requires unit-stride memory accesses—those in which all accesses are to contiguous memory locations.

For data that will be used only once in a procedure, consider using non-temporal accesses. Such accesses are not burdened by the overhead of cache protocols.

- 3.10.6 Keep Common Operands in Registers** Keep frequently used values in registers rather than in memory. This avoids the comparatively long latencies for accessing memory.
- 3.10.7 Avoid True Dependencies** Spread out true dependencies (write-read or flow dependencies) to increase the opportunities for parallel execution. This spreading out is not necessary for anti-dependencies and output dependencies.
- 3.10.8 Avoid Store-to-Load Dependencies** Store-to-load dependencies occur when data is stored to memory, only to be read back shortly thereafter. Hardware implementations of the architecture may contain means of accelerating such store-to-load dependencies, allowing the load to obtain the store data before it has been written to memory. However, this acceleration might be available only when the addresses and operand sizes of the store and the dependent load are matched, and when both memory accesses are aligned. Performance is typically optimized by avoiding such dependencies altogether and keeping the data, including temporary variables, in registers.
- 3.10.9 Optimize Stack Allocation** When allocating space on the stack for local variables and/or outgoing parameters within a procedure, adjust the stack pointer and use moves rather than pushes. This method of allocation allows random access to the outgoing parameters, so that they can be set up when they are calculated instead of being held in a register or memory until the procedure call. This method also reduces stack-pointer dependencies.
- 3.10.10 Consider Repeat-Prefix Setup Time** The repeat instruction prefixes have a setup overhead. If the repeated count is variable, the overhead can sometimes be avoided by substituting a simple loop to move or store the data. Repeated string instructions can be expanded into equivalent sequences of inline loads and stores. For details, see “Repeat Prefixes” in Volume 3.
- 3.10.11 Replace GPR with Media Instructions** Some integer-based programs can be made to run faster by using 128-bit media or 64-bit media instructions. These instructions have their own register sets. Because of this, they relieve register pressure on the GPR registers. For loads, stores, adds, shifts, etc., media instructions may be good substitutes for general-purpose integer instructions. GPR registers are freed up, and the media instructions increase opportunities for parallel operations.

**3.10.12 Organize Data
in Memory Blocks**

Organize frequently accessed constants and coefficients into cache-line-size blocks and prefetch them. Procedures that access data arranged in memory-bus-sized blocks, or memory-burst-sized blocks, can make optimum use of the available memory bandwidth.

4 128-Bit Media and Scientific Programming

This chapter describes the 128-bit media and scientific programming model. This model includes all instructions that access the 128-bit XMM registers—called the *128-bit media instructions*. These instructions perform integer and floating-point operations primarily on vector operands (a few of the instructions take scalar operands). They can speed up certain types of procedures—typically high-performance media and scientific procedures—by substantial factors, depending on data-element size and the regularity and locality of data accesses to memory.

4.1 Overview

4.1.1 Origins

The 128-bit media instruction set includes instructions originally introduced as the streaming SIMD extensions (SSE), and instructions added in subsequent extensions (SSE2, and SSE3). For details on the instruction set origin of each instruction, see “Instruction Subsets and CPUID Feature Sets” in Volume 3.

4.1.2 Compatibility

The 128-bit media instructions can be executed in any of the architecture’s operating modes. Existing SSE, SSE2 and SSE3 binary programs run in legacy and compatibility modes without modification. The support provided by the AMD64 architecture for such binaries is identical to that provided by legacy x86 architectures.

To run in 64-bit mode, legacy 128-bit media programs must be recompiled. The recompilation has no side effects on such programs, other than to provide access to the following additional resources:

- Access to the eight extended XMM registers (for a total of 16 XMM registers).
- Access to the eight extended general-purpose registers (for a total of 16 GPRs).
- Access to the extended 64-bit width of all GPRs.
- Access to the 64-bit virtual address space.
- Access to the RIP-relative addressing mode.

The 128-bit media instructions use data registers, a control and status register (MXCSR), rounding control, and an exception reporting and response mechanism that are distinct from and functionally independent of those used by the x87 floating-point instructions. Because of this, 128-bit media programming support usually requires exception handlers that are distinct from those used for x87 exceptions. This support is provided by virtually all legacy operating systems for the x86 architecture.

4.2 Capabilities

The 128-bit media instructions are designed to support media and scientific applications. The vector operands used by these instructions allow applications to operate in parallel on multiple elements of vectors. The elements can be integers (from bytes to quadwords) or floating-point (either single-precision or double-precision). Arithmetic operations produce signed, unsigned, and/or saturating results.

The availability of several types of vector move instructions and (in 64-bit mode) twice the legacy number of XMM registers (a total of 16 such registers) can eliminate substantial memory-access overhead, making a substantial difference in performance.

4.2.1 Types of Applications

Typical media applications well-suited to the 128-bit media programming model include a broad range of audio, video, and graphics programs. For example, music synthesis, speech synthesis, speech recognition, audio and video compression (encoding) and decompression (decoding), 2D and 3D graphics, streaming video (up to high-definition TV), and digital signal processing (DSP) kernels are all likely to experience higher performance using 128-bit media instructions than using other types of instructions in AMD64 architecture.

Such applications commonly use small-sized integer or single-precision floating-point data elements in repetitive loops, in which the typical operations are inherently parallel. For example, 8-bit and 16-bit data elements are commonly used for pixel information in graphics applications, in which each of the RGB pixel components (red, green, blue, and alpha) are represented by an 8-bit or 16-bit integer. 16-bit data elements are also commonly used for audio sampling.

The 128-bit media instructions allow multiple data elements like these to be packed into 128-bit vector operands located in XMM registers or memory. The instructions operate in parallel on each of the elements in these vectors. For example, 16 elements of 8-bit data can be packed into a 128-bit vector operand, so that all 16 byte elements are operated on simultaneously, and in pairs of source operands, by a single instruction.

The 128-bit media instructions also support a broad spectrum of scientific applications. For example, their ability to operate in parallel on double-precision floating-point vector elements makes them well-suited to computations like dense systems of linear equations, including matrix and vector-space operations with real and complex numbers. In professional CAD applications, for example, high-performance physical-modeling algorithms can be implemented to simulate processes such as heat transfer or fluid dynamics.

4.2.2 Integer Vector Operations

Most of the 128-bit media arithmetic instructions perform parallel operations on pairs of vectors. *Vector* operations are also called *packed* or *SIMD* (single-instruction, multiple-data) operations. They take vector operands consisting of multiple elements, and all elements are operated on in parallel. Figure 4-1 shows an example of parallel operations on pairs of 16 byte-sized integers in the source operands. The result of the operation replaces the first source operand. There are also instructions that operate on vectors of words, doublewords, or quadwords.

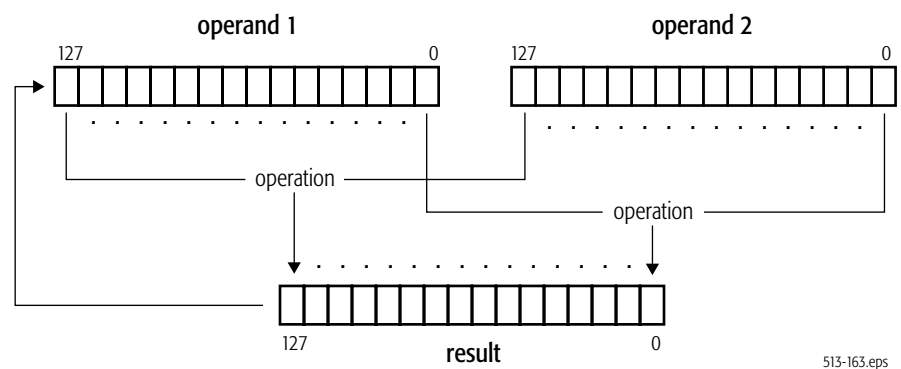
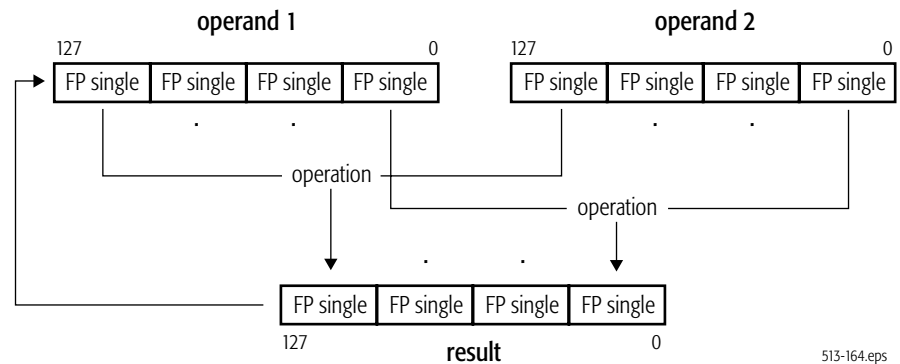

Figure 4-1. Parallel Operations on Vectors of Integer Elements

4.2.3 Floating-Point Vector Operations

There are almost as many 128-bit floating-point instructions as integer instructions. Figure 4-2 shows an example of parallel operations on vectors containing four 32-bit single-precision floating-point values. There are also instructions that operate on vectors containing two 64-bit double-precision floating-point values.



513-164.eps

Figure 4-2. Parallel Operations on Vectors of Floating-Point Elements

Integer and floating-point instructions can be freely intermixed in the same procedure. The floating-point instructions allow media applications such as 3D graphics to accelerate geometry, clipping, and lighting calculations. Pixel data are typically integer-based, although both integer and floating-point instructions are often required to operate completely on the data. For example, software can change the viewing perspective of a 3D scene through transformation matrices by using floating-point instructions in the same procedure that contains integer operations on other aspects of the graphics data.

It is typically much easier to write 128-bit media programs using floating-point instructions. Such programs perform better than x87 floating-point programs, because the XMM register file is flat rather than stack-oriented, there are twice as many registers (in 64-bit mode), and 128-bit media instructions can operate on two or four times the number of floating-point operands as can x87 instructions. This ability to operate in parallel on multiple pairs of floating-point elements often makes it possible to remove local temporary variables that would otherwise be needed in x87 floating-point code.

4.2.4 Data Conversion and Reordering

There are instructions that support data conversion of vector elements, including conversions between integer and floating-point data types—located in XMM registers, MMX™ registers, GPR registers, or memory—and conversions of element-ordering or precision. For example, the unpack instructions take two vector operands and interleave their low or high elements. Figure 4-3 shows an unpack and interleave operation on word-sized elements (PUNCKLWD). If the left-hand source operand has elements whose value is zero, the operation converts each element in the low half of the right-hand operand to a data type of twice its original precision—useful, for example, in multiply operations in which results may overflow or underflow.

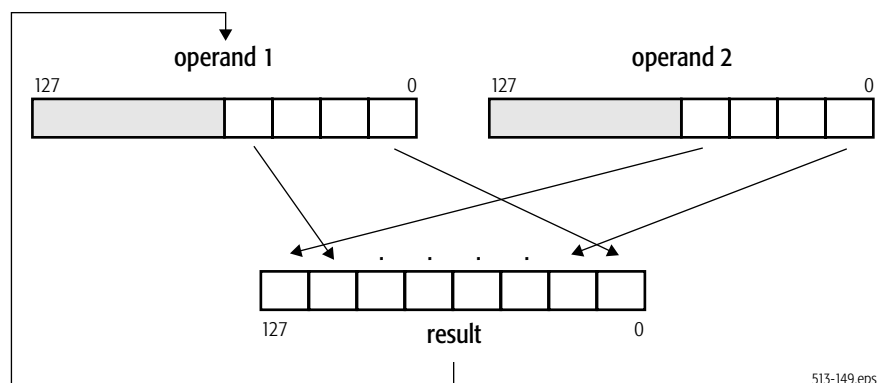

Figure 4-3. Unpack and Interleave Operation

There are also pack instructions, such as PACKSSDW shown in Figure 4-4 on page 136, that convert each element in a pair of vectors to lower precision by selecting the elements in the low half of each vector. Vector-shift instructions are also supported. They can scale each element in a vector to higher or lower values.

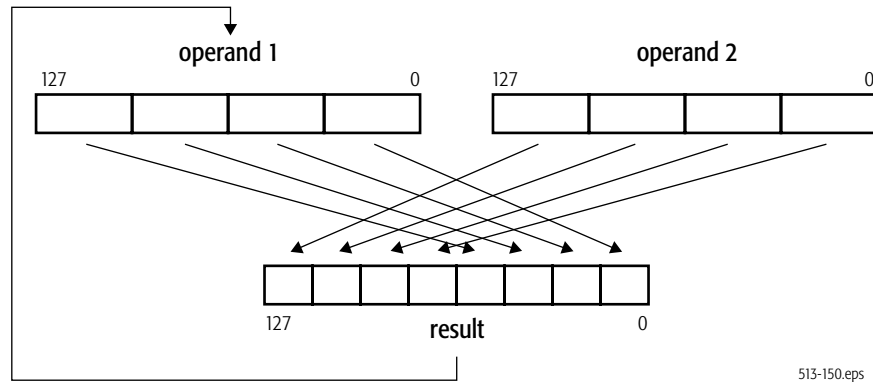

Figure 4-4. Pack Operation

Figure 4-5 shows one of many types of shuffle operation (PSHUFD). Here, the second operand is a vector containing doubleword elements, and an immediate byte provides shuffle control for up to 256 permutations of the elements. Shuffles are useful, for example, in color imaging when computing alpha saturation of RGB values. In this case, a shuffle instruction can replicate an alpha value in a register so that parallel comparisons with three RGB values can be performed.

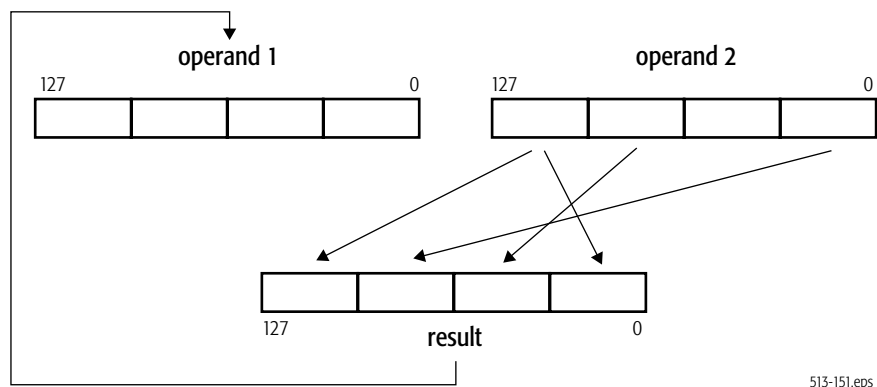

Figure 4-5. Shuffle Operation

There is an instruction that inserts a single word from a general-purpose register or memory into an XMM register, at a specified

location, leaving the other words in the XMM register unmodified.

4.2.5 **Block Operations**

Move instructions—along with unpack instructions—are among the most frequently used instructions in 128-bit media procedures. Figure 4-6 on page 138 shows the combined set of move operations supported by the integer and floating-point move instructions. These instructions provide a fast way to copy large amounts of data between registers or between registers and memory. They support block copies and sequential processing of contiguous data.

When moving between XMM registers, or between an XMM register and memory, each integer move instruction can copy up to 16 bytes of data. When moving between an XMM register and an MMX or GPR register, an integer move instruction can move 8 bytes of data. The floating-point move instructions can copy vectors of four single-precision or two double-precision floating-point operands in parallel.

Streaming-store versions of the move instructions permit bypassing the cache when storing data that is accessed only once. This maximizes memory-bus utilization and minimizes cache pollution. There is also a streaming-store integer move-mask instruction that stores bytes from one vector, as selected by mask values in a second vector. Figure 4-7 on page 139 shows the MASKMOVDQU operation. It can be used, for example, to handle end cases in block copies and block fills based on streaming stores.

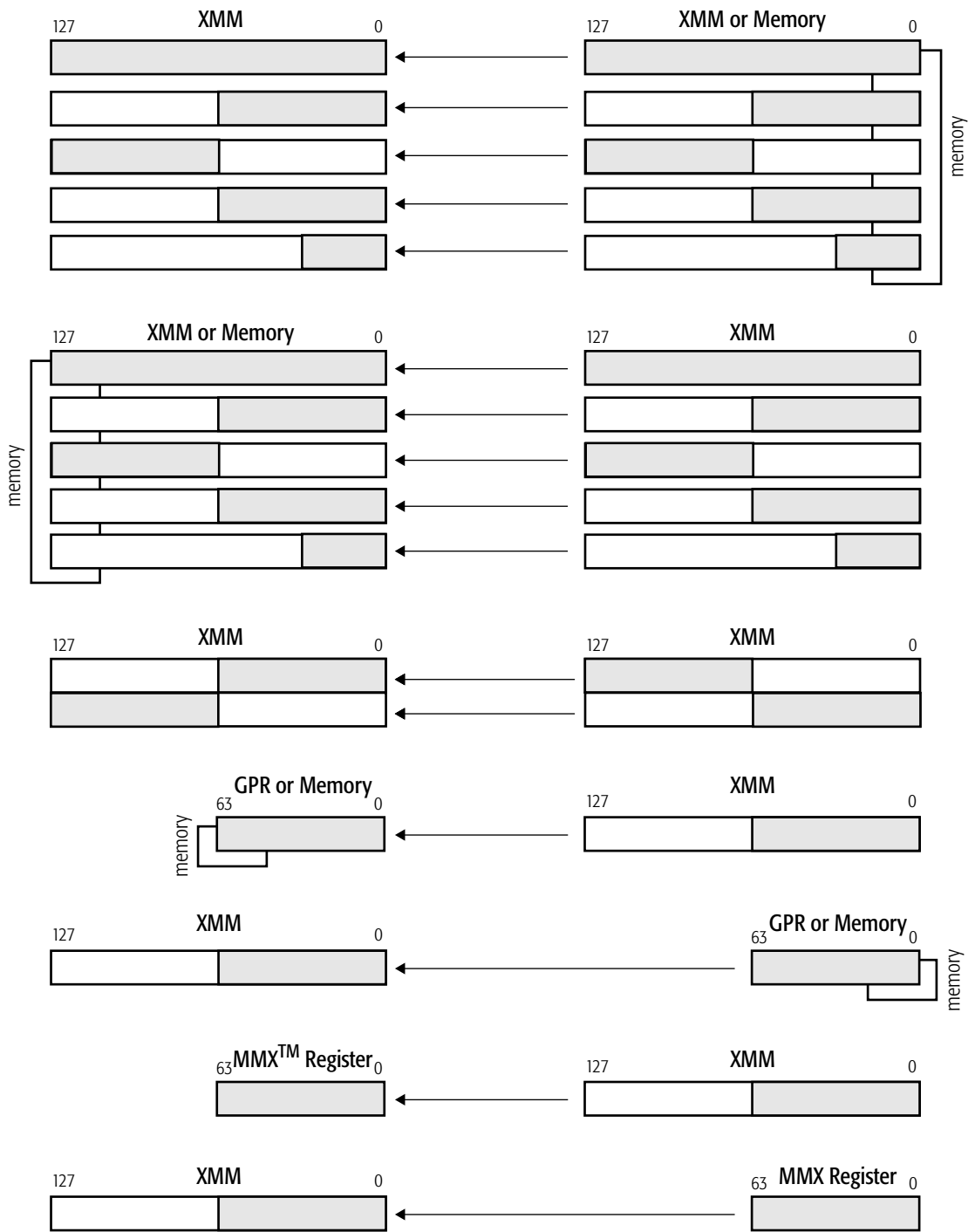

513-171.eps

Figure 4-6. Move Operations

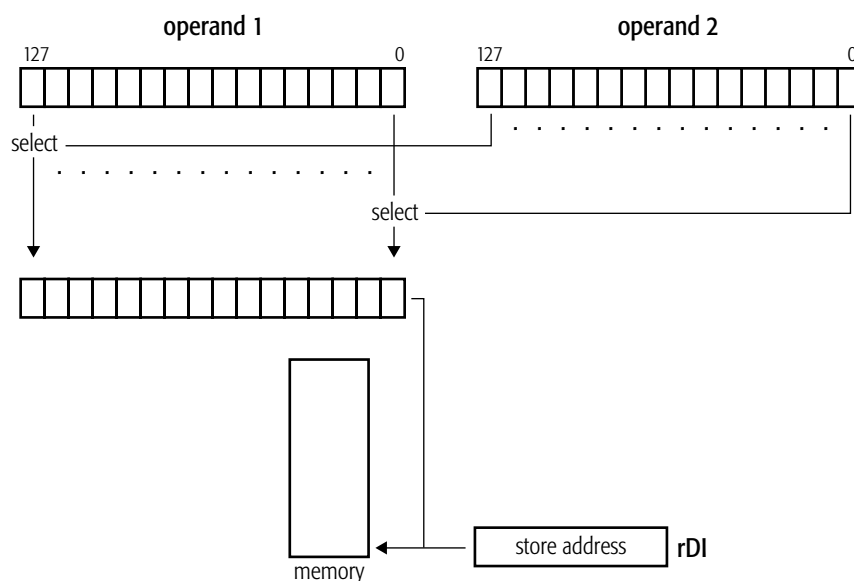

513-148.eps

Figure 4-7. Move Mask Operation

4.2.6 Matrix and Special Arithmetic Operations

The instruction set provides a broad assortment of vector add, subtract, multiply, divide, and square-root operations for use on matrices and other data structures common to media and scientific applications. It also provides special arithmetic operations including multiply-add, average, sum-of-absolute differences, reciprocal square-root, and reciprocal estimation.

Media applications often multiply and accumulate vector and matrix data. In 3D-graphics geometry, for example, objects are typically represented by triangles, each of whose vertices are located in 3D space by a matrix of coordinate values, and matrix transforms are performed to simulate object movement.

128-bit media integer and floating-point instructions can perform several types of matrix-vector or matrix-matrix operations, such as addition, subtraction, multiplication, and accumulation, to effect 3D transforms of vertices. Efficient matrix multiplication is further supported with instructions that can first transpose the elements of matrix rows and columns. These transpositions can make subsequent accesses to memory or cache more efficient when performing arithmetic matrix operations.

Figure 4-8 shows a vector multiply-add instruction (PMADDWD) that multiplies vectors of 16-bit integer elements to yield intermediate results of 32-bit elements, which are then summed pair-wise to yield four 32-bit elements. This operation can be used with one source operand (for example, a coefficient) taken from memory and the other source operand (for example, the data to be multiplied by that coefficient) taken from an XMM register. It can also be used together with a vector-add operation to accumulate *dot product* results (also called *inner* or *scalar products*), which are used in many media algorithms such as those required for finite impulse response (FIR) filters, one of the commonly used DSP algorithms.

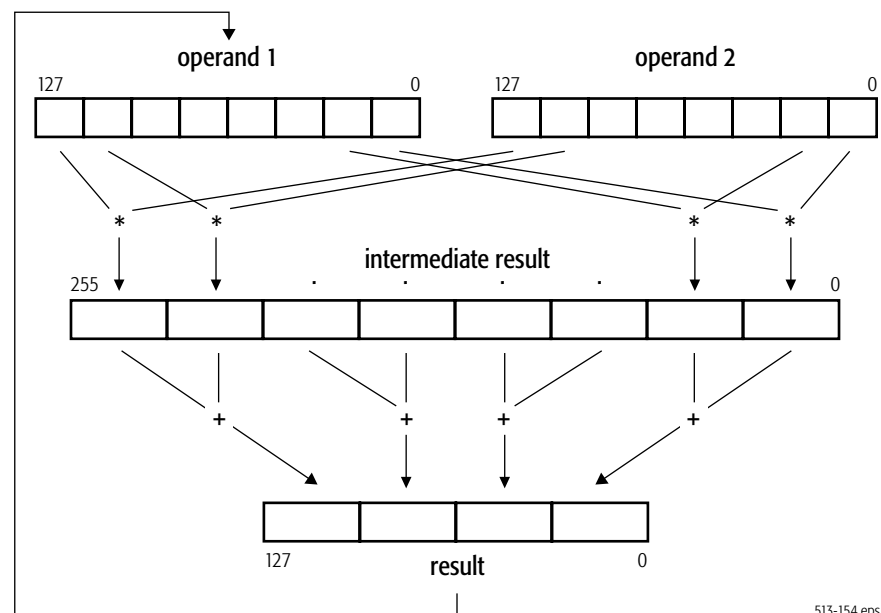
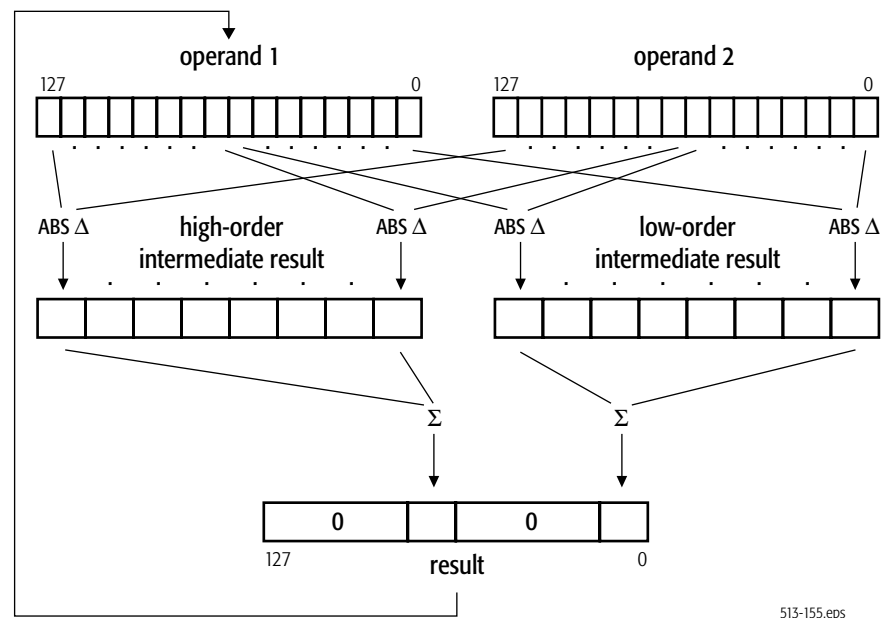

Figure 4-8. Multiply-Add Operation

There is also a sum-of-absolute-differences instruction (PSADBW), shown in Figure 4-9 on page 141. This is useful, for example, in computing motion-estimation algorithms for video compression.



513-155.eps

Figure 4-9. Sum-of-Absolute-Differences Operation

There is an instruction for computing the average of unsigned bytes or words. The instruction is useful for MPEG decoding, in which motion compensation involves many byte-averaging operations between and within macroblocks. In addition to speeding up these operations, the instruction also frees up registers and make it possible to unroll the averaging loops.

Some of the arithmetic and pack instructions produce vector results in which each element *saturates* independently of the other elements in the result vector. Such results are clamped (limited) to the maximum or minimum value representable by the destination data type when the true result exceeds that maximum or minimum representable value. Saturating data is useful for representing physical-world data, such as sound and color. It is used, for example, when combining values for pixel coloring.

4.2.7 Branch Removal

Branching is a time-consuming operation that, unlike most 128-bit media vector operations, does not exhibit parallel behavior (there is only one branch target, not multiple targets, per branch instruction). In many media applications, a branch involves selecting between only a few (often only two) cases. Such branches can be replaced with 128-bit media vector

compare and vector logical instructions that simulate predicated execution or conditional moves.

Figure 4-10 shows an example of a non-branching sequence that implements a two-way multiplexer—one that is equivalent to the ternary operator “?:” in C and C++. The comparable code sequence is explained in “Compare and Write Mask” on page 188.

The sequence in Figure 4-10 begins with a vector compare instruction that compares the elements of two source operands in parallel and produces a mask vector containing elements of all 1s or 0s. This mask vector is ANDed with one source operand and ANDed-Not with the other source operand to isolate the desired elements of both operands. These results are then ORed to select the relevant elements from each operand. A similar branch-removal operation can be done using floating-point source operands.

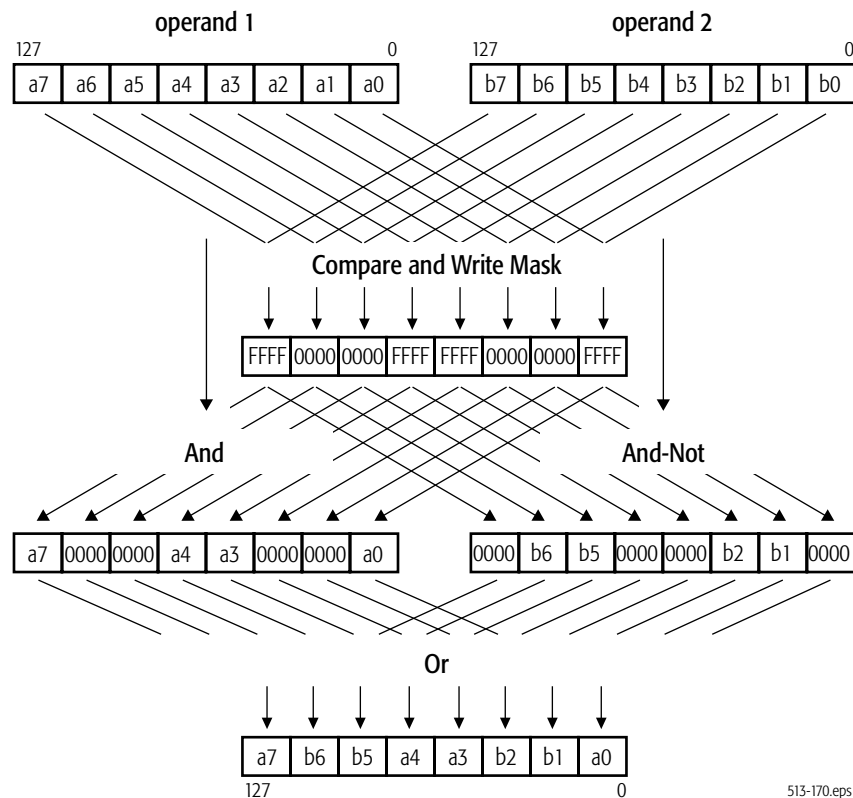

513-170.eps

Figure 4-10. Branch-Removal Sequence

The min/max compare instructions, for example, are useful for clamping, such as color clamping in 3D graphics, without the need for branching. Figure 4-11 illustrates a move-mask instruction (PMOVMASKB) that copies sign bits to a general-purpose register (GPR). The instruction can extract bits from mask patterns, or zero values from quantized data, or sign bits—resulting in a byte that can be used for data-dependent branching.

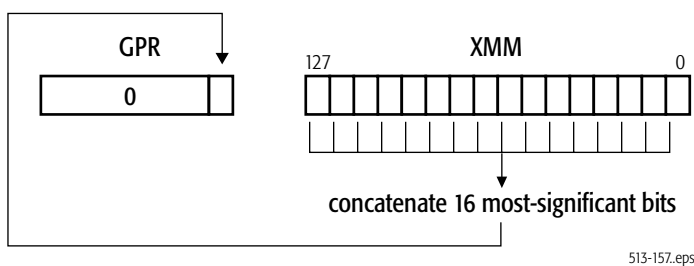

513-157.eps

Figure 4-11. Move Mask Operation

4.3 Registers

Operands for most 128-bit media instructions are located in XMM registers or memory. Operation of the 128-bit media instructions is supported by the MXCSR control and status register. A few 128-bit media instructions—those that perform data conversion or move operations—can have operands located in MMX™ registers or general-purpose registers (GPRs).

4.3.1 XMM Registers

Sixteen 128-bit XMM data registers, *xmm0*–*xmm15*, support the 128-bit media instructions. Figure 4-12 on page 144 shows these registers. They can hold operands for both vector and scalar operations with integer and floating-point data types. The high eight XMM registers, *xmm8*–*xmm15*, are available to software running in 64-bit mode for instructions that use a REX prefix (see “REX Prefixes” on page 91).

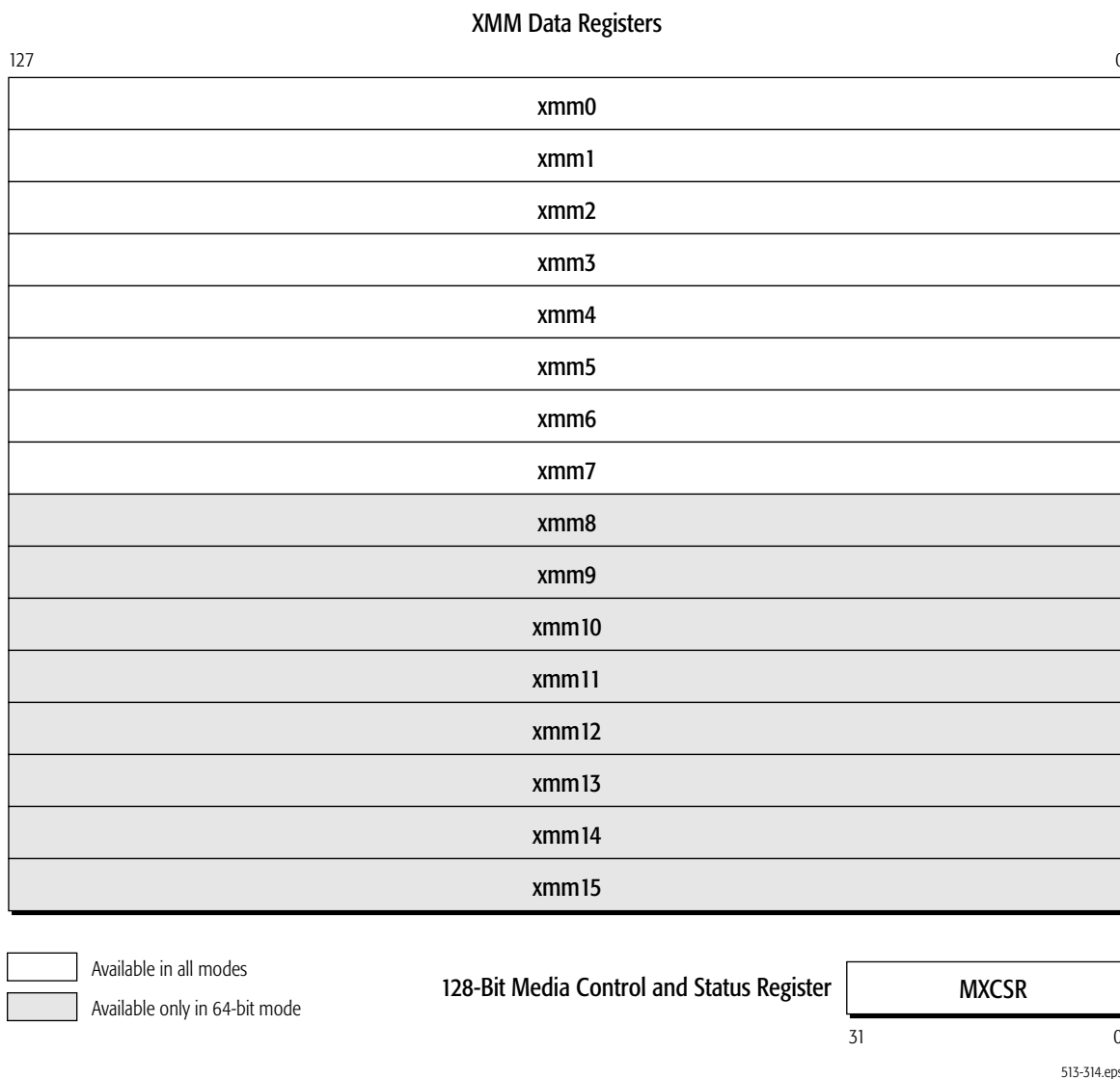

Figure 4-12. 128-bit Media Registers

Upon power-on reset, all 16 XMM registers are cleared to +0.0. However, initialization by means of the #INIT external input signal does not change the state of the XMM registers.

4.3.2 MXCSR Register

Figure 4-13 on page 145 shows a detailed view of the 128-bit media-instruction control and status register (MXCSR). All bits in this register are read/write. The fields within the MXCSR apply only to operations performed by 128-bit media

instructions. Software can load the register from memory using the FXRSTOR or LDMXCSR instructions, and it can store the register to memory using the FXSAVE or STMXCSR instructions.

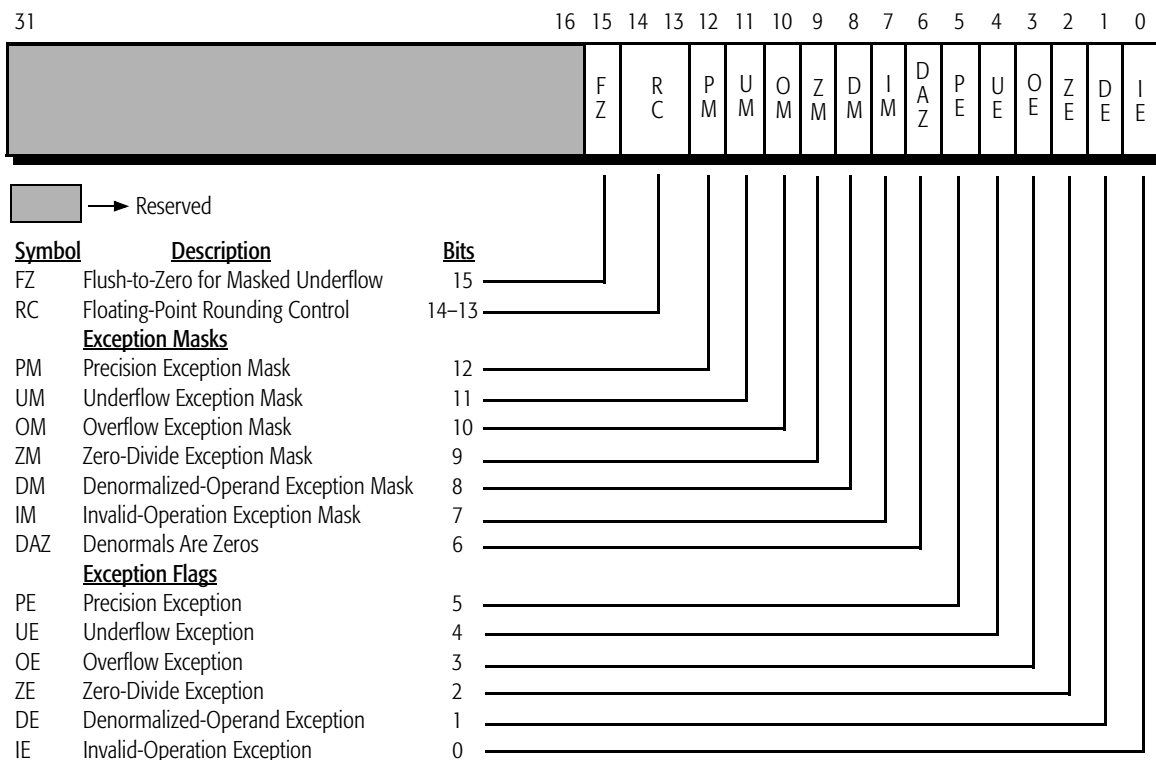

Figure 4-13. 128-Bit Media Control and Status Register (MXCSR)

Upon power-on reset, the low 16 bits of the MXCSR are initialized with the value 1F80h, the bit values of which are shown in Table 4-1 on page 146. However, initialization by means of the #INIT external input signal does not change the state of the XMM registers.

Table 4-1. MXCSR Register Reset Values

Field	Bit	Description	Reset Bit-Value
IE	0	Invalid-Operation Exception	0
DE	1	Denormalized-Operand Exception	0
ZE	2	Zero-Divide Exception	0
OE	3	Overflow Exception	0
UE	4	Underflow Exception	0
PE	5	Precision Exception	0
DAZ	6	Denormals are Zeros	0
IM	7	Invalid-Operation Exception Mask	1
DM	8	Denormalized-Operand Exception Mask	1
ZM	9	Zero-Divide Exception Mask	1
OM	10	Overflow Exception Mask	1
UM	11	Underflow Exception Mask	1
PM	12	Precision Exception Mask	1
RC	14–13	Floating-Point Rounding Control	00
FZ	15	Flush-to-Zero for Masked Underflow	0

The bits in the MXCSR register are defined immediately below, starting with bit 0. The six exception flags (IE, DE, ZE, OE, UE, PE) are sticky bits. Once set by the processor, such a bit remains set until software clears it. For details about the causes of SIMD floating-point exceptions indicated by bits 5–0, see “SIMD Floating-Point Exception Causes” on page 219. For details about the masking of these exceptions, see “SIMD Floating-Point Exception Masking” on page 226.

Invalid-Operation Exception (IE). Bit 0. The processor sets this bit to 1 when an invalid-operation exception occurs. These exceptions are caused by many types of errors, such as an invalid operand.

Denormalized-Operand Exception (DE). Bit 1. The processor sets this bit to 1 when one of the source operands of an instruction is in denormalized form, except that if software has set the

denormals are zeros (DAZ) bit, the processor does not set the DE bit. (See “Denormalized (Tiny) Numbers” on page 158.)

Zero-Divide Exception (ZE). Bit 2. The processor sets this bit to 1 when a non-zero number is divided by zero.

Overflow Exception (OE). Bit 3. The processor sets this bit to 1 when the absolute value of a rounded result is larger than the largest representable normalized floating-point number for the destination format. (See “Normalized Numbers” on page 157.)

Underflow Exception (UE). Bit 4. The processor sets this bit to 1 when the absolute value of a rounded non-zero result is too small to be represented as a normalized floating-point number for the destination format. (See “Normalized Numbers” on page 157.)

When masked by the UM bit (bit 11), the processor only reports a UE exception if the UE occurs *together with* a precision exception (PE). Also, see bit 15, the flush-to-zero (FZ) bit.

Precision Exception (PE). Bit 5. The processor sets this bit to 1 when a floating-point result, after rounding, differs from the infinitely precise result and thus cannot be represented exactly in the specified destination format. The PE exception is also called the *inexact-result* exception.

Denormals Are Zeros (DAZ). Bit 6. Software can set this bit to 1 to enable the DAZ mode, if the hardware implementation supports this mode. In the DAZ mode, when the processor encounters source operands in the denormalized format it converts them to signed zero values, with the sign of the denormalized source operand, before operating on them, and the processor does not set the denormalized-operand exception (DE) bit, regardless of whether such exceptions are masked or unmasked.

Support for the DAZ bit is indicated by the MXCSR Mask field in the FXSAVE memory image, as described in “Saving Media and x87 Processor State” in Volume 2. The DAZ mode does not comply with the *IEEE Standard for Binary Floating-Point Arithmetic* (ANSI/IEEE Std 754).

Exception Masks (PM, UM, OM, ZM, DM, IM). Bits 12–7. Software can set these bits to mask, or clear this bits to unmask, the corresponding six types of SIMD floating-point exceptions (PE,

UE, OE, ZE, DE, IE). A bit masks its exception type when set to 1, and unmask it when cleared to 0.

In general, masking a type of exception causes the processor to handle all subsequent instances of the exception type in a default way (the UE exception has an unusual behavior). Unmasking the exception type causes the processor to branch to the SIMD floating-point exception service routine when an exception occurs. For details about the processor's responses to masked and unmasked exceptions, see "SIMD Floating-Point Exception Masking" on page 226.

Floating-Point Rounding Control (RC). Bit 14–13. Software uses these bits to specify the rounding method for 128-bit media floating-point operations. The choices are:

- 00 = round to nearest (default)
- 01 = round down
- 10 = round up
- 11 = round toward zero

For details, see "Floating-Point Rounding" on page 162.

Flush-to-Zero(FZ). Bit 15. If the rounded result is tiny and the underflow mask is set, the FTZ bit causes the result to be flushed to zero. This naturally causes the result to be inexact, which causes both PE and UE to be set. The sign returned with the zero is the sign of the true result. The FTZ bit does not have any effect if the underflow mask is 0.

This response does not comply with the IEEE 754 standard, but it may offer higher performance than can be achieved by responding to an underflow in this circumstance. The FZ bit is only effective if the UM bit is set to 1. If the UM bit is cleared to 0, the FZ bit is ignored. For details, see Table 4-15 on page 227.

4.3.3 Other Data Registers

Some 128-bit media instructions that perform data transfer, data conversion or data reordering operations ("Data Transfer" on page 166, "Data Conversion" on page 171, and "Data Reordering" on page 173) can access operands in the MMX or general-purpose registers (GPRs). When addressing GPRs registers in 64-bit mode, the REX instruction prefix can be used to access the extended GPRs, as described in "REX Prefixes" on page 91.

For a description of the GPR registers, see “Registers” on page 27. For a description of the MMX registers, see “MMX™ Registers” on page 245.

4.3.4 **rFLAGS Registers**

The COMISS, COMISD, UCOMISS, and UCOMISD instructions, described in “Compare” on page 210, write flag bits in the rFLAGS register. For a description of the rFLAGS register, see “Flags Register” on page 38.

4.4 Operands

Operands for a 128-bit media instruction are either referenced by the instruction's opcode or included as an immediate value in the instruction encoding. Depending on the instruction, referenced operands can be located in registers or memory. The data types of these operands include vector and scalar floating-point, and vector and scalar integer.

4.4.1 **Data Types**

Figure 4-14 on page 150 shows the register images of the 128-bit media data types. These data types can be interpreted by instruction syntax and/or the software context as one of the following types of values:

- Vector (packed) single-precision (32-bit) floating-point numbers.
- Vector (packed) double-precision (64-bit) floating-point numbers.
- Vector (packed) signed (two's-complement) integers.
- Vector (packed) unsigned integers.
- Scalar signed (two's-complement) integers.
- Scalar unsigned integers.

Hardware does not check or enforce the data types for instructions. Software is responsible for ensuring that each operand for an instruction is of the correct data type. If data produced by a previous instruction is of a type different from that used by the current instruction, and the current instruction sources such data, the current instruction may incur a latency penalty, depending on the hardware implementation.

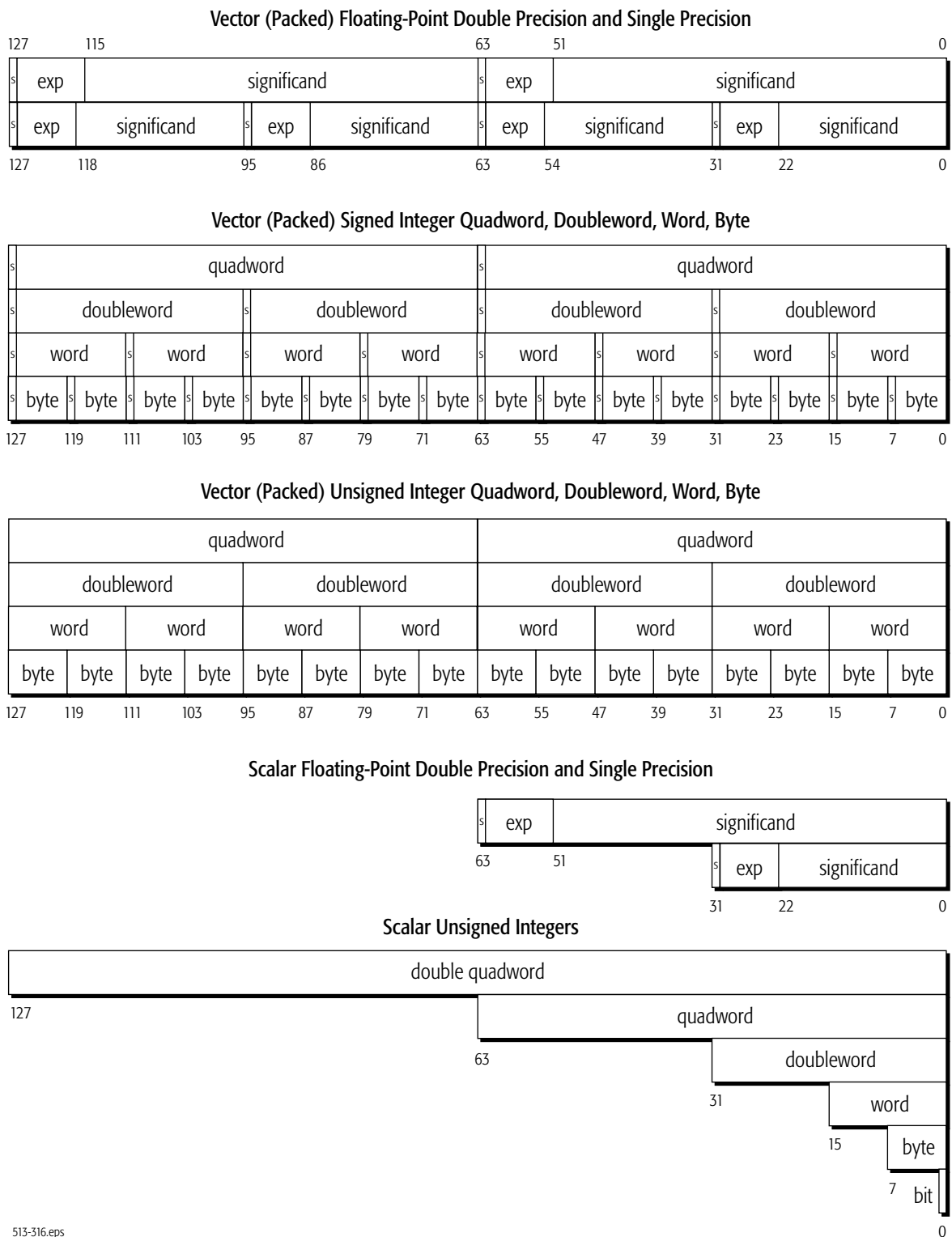

Figure 4-14. 128-Bit Media Data Types

Software can interpret the data types in ways other than those shown in Figure 4-14—such as bit fields or fractional numbers—but the 128-bit media instructions do not directly support such interpretations and software must handle them entirely on its own.

4.4.2 Operand Sizes and Overrides

Operand sizes for 128-bit media instructions are determined by instruction opcodes. Some of these opcodes include an operand-size override prefix, but this prefix acts in a special way to modify the opcode and is considered an integral part of the opcode. The general use of the 66h operand-size override prefix described in “Instruction Prefixes” on page 87 does not apply to 128-bit media instructions.

For details on the use of operand-size override prefixes in 128-bit media instructions, see the opcodes in “128-Bit Media Instruction Reference” in Volume 4.

4.4.3 Operand Addressing

Depending on the 128-bit media instruction, referenced operands may be in registers or memory.

Register Operands. Most 128-bit media instructions can access source and destination operands in XMM registers. A few of these instructions access the MMX registers, GPR registers, rFLAGS register, or MXCSR register. The type of register addressed is specified in the instruction syntax. When addressing GPR or XMM registers, the REX instruction prefix can be used to access the extended GPR or XMM registers, as described in “Instruction Prefixes” on page 216.

Memory Operands. Most 128-bit media instructions can read memory for source operands, and some of the instructions can write results to memory. “Memory Addressing” on page 16, describes the general methods for addressing memory operands.

Immediate Operands. Immediate operands are used in certain data-conversion, vector-shift, and vector-compare instructions. Such instructions take 8-bit immediates, which provide control for the operation.

I/O Ports. I/O ports in the I/O address space cannot be directly addressed by 128-bit media instructions, and although memory-mapped I/O ports can be addressed by such instructions, doing

so may produce unpredictable results, depending on the hardware implementation of the architecture.

4.4.4 Data Alignment

128-bit media instructions that access a 128-bit operand in memory incur a general-protection exception (#GP) if the operand is not aligned to a 16-byte boundary, except for the following instructions:

- MASKMOVDQU—Masked Move Double Quadword Unaligned.
- MOVDQU—Move Unaligned Double Quadword.
- MOVUPD—Move Unaligned Packed Double-Precision Floating-Point.
- MOVUPS—Move Unaligned Packed Single-Precision Floating-Point.
- LDDQU—Load Unaligned Double Quadword

For other 128-bit media instructions, the architecture does not impose data-alignment requirements. However, the consequence of storing operands at unaligned locations is that accesses to those operands may require more processor and bus cycles than for aligned accesses. See “Data Alignment” on page 48 for details.

4.4.5 Integer Data Types

The 128-bit media instructions that support operations on integer data types are summarized in “Instruction Summary—Integer Instructions” on page 164. The characteristics of these data types are described below.

Sign. Many of the 128-bit media instructions have variants for operating on signed or unsigned integers. For signed integers, the sign bit is the most-significant bit—bit 7 for a byte, bit 15 for a word, bit 31 for a doubleword, bit 63 for a quadword, or bit 127 for a double quadword. Arithmetic instructions that are not specifically named as unsigned perform signed two’s-complement arithmetic.

Range of Representable Values. Table 4-2 on page 153 shows the range of representable values for the integer data types.

Table 4-2. Range of Values in 128-Bit Media Integer Data Types

Data-Type Interpretation		Byte	Word	Doubleword	Quadword	Double Quadword
Unsigned integers	Base-2 (exact)	0 to $+2^8-1$	0 to $+2^{16}-1$	0 to $+2^{32}-1$	0 to $+2^{64}-1$	0 to $+2^{128}-1$
	Base-10 (approx.)	0 to 255	0 to 65,535	0 to $4.29 * 10^9$	0 to $1.84 * 10^{19}$	0 to $3.40 * 10^{38}$
Signed integers ¹	Base-2 (exact)	-2^7 to $+(2^7-1)$	-2^{15} to $+(2^{15}-1)$	-2^{31} to $+(2^{31}-1)$	-2^{63} to $+(2^{63}-1)$	-2^{127} to $+(2^{127}-1)$
	Base-10 (approx.)	-128 to +127	-32,768 to +32,767	$-2.14 * 10^9$ to $+2.14 * 10^9$	$-9.22 * 10^{18}$ to $+9.22 * 10^{18}$	$-1.70 * 10^{38}$ to $+1.70 * 10^{38}$
Note:						
1. The sign bit is the most-significant bit (bit 7 for a byte, bit 15 for a word, bit 31 for doubleword, bit 63 for quadword, bit 127 for double quadword).						

Saturation. Saturating (also called limiting or clamping) instructions limit the value of a result to the maximum or minimum value representable by the applicable data type. Saturating versions of integer vector-arithmetic instructions operate on byte-sized and word-sized elements. These instructions—for example, `PACKx`, `PADDsx`, `PADDUSx`, `PSUBsx`, and `PSUBUSx`—saturate signed or unsigned data at the vector-element level when the element reaches its maximum or minimum representable value. Saturation avoids overflow or underflow errors.

The examples in Table 4-3 on page 154 illustrate saturating and non-saturating results with word operands. Saturation for other data-type sizes follows similar rules. Once saturated, the saturated value is treated like any other value of its type. For example, if `0001h` is subtracted from the saturated value, `7FFFh`, the result is `7FFEh`.

Table 4-3. Saturation Examples

Operation	Non-Saturated Infinitely Precise Result	Saturated Signed Result	Saturated Unsigned Result
7000h + 2000h	9000h	7FFFh	9000h
7000h + 7000h	E000h	7FFFh	E000h
F000h + F000h	1E000h	E000h	FFFFh
9000h + 9000h	12000h	8000h	FFFFh
7FFFh + 0100h	80FFh	7FFFh	80FFh
7FFFh + FF00h	17EFFh	7EFFh	FFFFh

Arithmetic instructions not specifically designated as saturating perform non-saturating, twos-complement arithmetic.

Other Fixed-Point Operands. The architecture provides specific support only for integer fixed-point operands—those in which an implied binary point is always located to the right of bit 0. Nevertheless, software may use fixed-point operands in which the implied binary point is located in any position. In such cases, software is responsible for managing the interpretation of such implied binary points, as well as any redundant sign bits that may occur during multiplication.

4.4.6 Floating-Point Data Types

The 128-bit media floating-point instructions take vector or scalar operands, depending on the instruction. The vector instructions operate in parallel on up to four, or four pairs, of single-precision floating-point values or up to two, or two pairs, of double-precision floating-point values. The scalar instructions operate on only one, or one pair, of single-precision or double-precision operands.

Floating-Point Data Types. The floating-point data types, shown in Figure 4-15 on page 155, include 32-bit single precision and 64-bit double precision. Both formats are fully compatible with the *IEEE Standard for Binary Floating-Point Arithmetic* (ANSI/IEEE Std 754). The 128-bit media instructions operate internally on floating-point data types in the precision specified by each instruction.

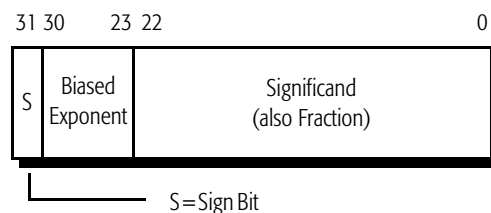
Single Precision**Double Precision****Figure 4-15. 128-Bit Media Floating-Point Data Types**

Both of the floating-point data types consist of a sign (0 = positive, 1 = negative), a biased exponent (base-2), and a significand, which represents the integer and fractional parts of the number. The integer bit (also called the *J bit*) is implied (called a *hidden integer bit*). The value of an implied integer bit can be inferred from number encodings, as described in “Floating-Point Number Encodings” on page 160. The bias of the exponent is a constant which makes the exponent always positive and allows reciprocation, without overflow, of the smallest normalized number representable by that data type.

Specifically, the data types are formatted as follows:

- *Single-Precision Format*—This format includes a 1-bit sign, an 8-bit biased exponent whose value is 127, and a 23-bit significand. The integer bit is implied, making a total of 24 bits in the significand.
- *Double-Precision Format*—This format includes a 1-bit sign, an 11-bit biased exponent whose value is 1023, and a 52-bit significand. The integer bit is implied, making a total of 53 bits in the significand.

Table 4-4 on page 156 shows the range of finite values representable by the two floating-point data types.

Table 4-4. Range of Values in Normalized Floating-Point Data Types

Data Type	Range of Normalized ¹ Values	
	Base 2 (exact)	Base 10 (approximate)
Single Precision	2^{-126} to $2^{127} * (2 - 2^{-23})$	$1.17 * 10^{-38}$ to $+3.40 * 10^{38}$
Double Precision	2^{-1022} to $2^{1023} * (2 - 2^{-52})$	$2.23 * 10^{-308}$ to $+1.79 * 10^{308}$

Note:
1. See “Floating-Point Number Representation” on page 157 for a definition of “normalized”.

For example, in the single-precision format, the largest normal number representable has an exponent of FEh and a significand of 7FFFFFFh, with a numerical value of $2^{127} * (2 - 2^{-23})$. Results that overflow above the maximum representable value return either the maximum representable normalized number (see “Normalized Numbers” on page 157) or infinity, with the sign of the true result, depending on the rounding mode specified in the rounding control (RC) field of the MXCSR register. Results that underflow below the minimum representable value return either the minimum representable normalized number or a denormalized number (see “Denormalized (Tiny) Numbers” on page 158), with the sign of the true result, or a result determined by the SIMD floating-point exception handler, depending on the rounding mode and the underflow-exception mask (UM) in the MXCSR register (see “Unmasked Responses” on page 229).

Compatibility with x87 Floating-Point Data Types. The results produced by 128-bit media floating-point instructions comply fully with the *IEEE Standard for Binary Floating-Point Arithmetic* (ANSI/IEEE Std 754), because these instructions represent data in the single-precision or double-precision data types throughout their operations. The x87 floating-point instructions, however, by default perform operations in the double-extended-precision format. Because of this, x87 instructions operating on the same source operands as 128-bit media floating-point instructions may return results that are slightly different in their least-significant bits.

4.4.7 Floating-Point Number Representation

A 128-bit media floating-point value can be one of five types, as follows:

- Normal
- Denormal (Tiny)
- Zero
- Infinity
- Not a Number (NaN)

In common engineering and scientific usage, floating-point numbers—also called *real numbers*—are represented in base (radix) 10. A non-zero number consists of a *sign*, a normalized *significand*, and a signed *exponent*, as in:

+2.71828 e0

Both large and small numbers are representable in this notation, subject to the limits of data-type precision. For example, a million in base-10 notation appears as +1.00000 e6 and -0.0000383 is represented as -3.83000 e-5. A non-zero number can always be written in *normalized form*—that is, with a leading non-zero digit immediately before the decimal point. Thus, a normalized significand in base-10 notation is a number in the range [1,10). The signed exponent specifies the number of positions that the decimal point is shifted.

Unlike the common engineering and scientific usage described above, 128-bit media floating-point numbers are represented in base (radix) 2. Like its base-10 counterpart, a normalized base-2 significand is written with its leading non-zero digit immediately to the left of the radix point. In base-2 arithmetic, a non-zero digit is always a one, so the range of a binary significand is [1,2):

+1.fraction ±exponent

The leading non-zero digit is called the *integer bit*. As shown in Figure 4-15, the integer bit is omitted (and called the *hidden integer bit*) in the single-precision and the double-precision floating-point formats, because its implied value is always 1 in a normalized significand (0 in a denormalized significand), and the omission allows an extra bit of precision.

The following sections describe the number representations.

Normalized Numbers. Normalized floating-point numbers are the most frequent operands for 128-bit media instructions. These

are finite, non-zero, positive or negative numbers in which the integer bit is 1, the biased exponent is non-zero and non-maximum, and the fraction is any representable value. Thus, the significand is within the range of [1, 2). Whenever possible, the processor represents a floating-point result as a normalized number.

Denormalized (Tiny) Numbers. Denormalized numbers (also called *tiny* numbers) are smaller than the smallest representable normalized numbers. They arise through an underflow condition, when the exponent of a result lies below the representable minimum exponent. These are finite, non-zero, positive or negative numbers in which the integer bit is 0, the biased exponent is 0, and the fraction is non-zero.

The processor generates a denormalized-operand exception (DE) when an instruction uses a denormalized *source operand*. The processor may generate an underflow exception (UE) when an instruction produces a rounded, non-zero *result* that is too small to be represented as a normalized floating-point number in the destination format, and thus is represented as a denormalized number. If a result, after rounding, is too small to be represented as the minimum denormalized number, it is represented as zero. (See “Exceptions” on page 217 for specific details.)

Denormalization may correct the exponent by placing leading zeros in the significand. This may cause a loss of precision, because the number of significant bits in the fraction is reduced by the leading zeros. In the single-precision floating-point format, for example, normalized numbers have biased exponents ranging from 1 to 254 (the unbiased exponent range is from –126 to +127). A true result with an exponent of, say, –130, undergoes denormalization by right-shifting the significand by the difference between the normalized exponent and the minimum exponent, as shown in Table 4-5.

Table 4-5. Example of Denormalization

Significand (base 2)	Exponent	Result Type
1.0011010000000000	–130	True result
0.0001001101000000	–126	Denormalized result

Zero. The floating-point zero is a finite, positive or negative number in which the integer bit is 0, the biased exponent is 0, and the fraction is 0. The sign of a zero result depends on the operation being performed and the selected rounding mode. It may indicate the direction from which an underflow occurred, or it may reflect the result of a division by $+\infty$ or $-\infty$.

Infinity. Infinity is a positive or negative number, $+\infty$ and $-\infty$, in which the integer bit is 1, the biased exponent is maximum, and the fraction is 0. The infinities are the maximum numbers that can be represented in floating-point format. Negative infinity is less than any finite number and positive infinity is greater than any finite number (i.e., the affine sense).

An infinite result is produced when a non-zero, non-infinite number is divided by 0 or multiplied by infinity, or when infinity is added to infinity or to 0. Arithmetic on infinities is exact. For example, adding any floating-point number to $+\infty$ gives a result of $+\infty$. Arithmetic comparisons work correctly on infinities. Exceptions occur only when the use of an infinity as a source operand constitutes an invalid operation.

Not a Number (NaN). NaNs are non-numbers, lying outside the range of representable floating-point values. The integer bit is 1, the biased exponent is maximum, and the fraction is non-zero. NaNs are of two types:

- *Signaling NaN (SNaN)*
- *Quiet NaN (QNaN)*

A QNaN is a NaN with the most-significant fraction bit set to 1, and an SNaN is a NaN with the most-significant fraction bit cleared to 0. When the processor encounters an SNaN as a source operand for an instruction, an invalid-operation exception (IE) occurs and a QNaN is produced as the result, if the exception is masked. In general, when the processor encounters a QNaN as a source operand for an instruction, the processor does not generate an exception but generates a QNaN as the result.

The processor never generates an SNaN as a result of a floating-point operation. When an invalid-operation exception (IE) occurs due to an SNaN operand, the invalid-operation exception mask (IM) bit determines the processor's response, as described in "SIMD Floating-Point Exception Masking" on page 226.

When a floating-point operation or exception produces a QNaN result, its value is determined by the rules in Table 4-6 on page 160.

Table 4-6. NaN Results

Source Operands (in either order)		NaN Result ¹
QNaN	Any non-NaN floating-point value, or single-operand instructions	Value of QNaN
SNaN	Any non-NaN floating-point value or, single-operand instructions	Value of SNaN converted to a QNaN ²
QNaN	QNaN	Value of operand 1
QNaN	SNaN	
SNaN	QNaN	Value of operand 1 converted to a QNaN ²
SNaN	SNaN	
Invalid-Operation Exception (IE) occurs without QNaN or SNaN source operands		Floating-point indefinite value ³ (a special form of QNaN)
Notes: <ol style="list-style-type: none"> 1. The NaN result is produced when the floating-point invalid-operation exception is masked. 2. The conversion is done by changing the most-significant fraction bit to 1. 3. See "Indefinite Values" on page 161. 		

4.4.8 Floating-Point Number Encodings

Supported Encodings. Table 4-7 on page 161 shows the floating-point encodings of supported numbers and non-numbers. The number categories are ordered from large to small. In this affine ordering, positive infinity is larger than any positive normalized number, which in turn is larger than any positive denormalized number, which is larger than positive zero, and so forth. Thus, the ordinary rules of comparison apply between categories as well as within categories, so that comparison of any two numbers is well-defined.

The actual exponent field length is 8 or 11 bits, and the fraction field length is 23 or 52 bits, depending on operand precision. The single-precision and double-precision formats do not include the integer bit in the significand (the value of the integer bit can be inferred from number encodings). Exponents

of both types are encoded in biased format, with respective biasing constants of 127 and 1023.

Table 4-7. Supported Floating-Point Encodings

Classification		Sign	Biased Exponent ¹	Significand ²
Positive Non-Numbers	SNaN	0	111 ... 111	1.011 ... 111 to 1.000 ... 001
	QNaN	0	111 ... 111	1.111 ... 111 to 1.100 ... 000
Positive Floating-Point Numbers	Positive Infinity ($+\infty$)	0	111 ... 111	1.000 ... 000
	Positive Normal	0	111 ... 110 to 000 ... 001	1.111 ... 111 to 1.000 ... 000
	Positive Denormal	0	000 ... 000	0.111 ... 111 to 0.000 ... 001
	Positive Zero	0	000 ... 000	0.000 ... 000
Negative Floating-Point Numbers	Negative Zero	1	000 ... 000	0.000 ... 000
	Negative Denormal	1	000 ... 000	0.000 ... 001 to 0.111 ... 111
	Negative Normal	1	000 ... 001 to 111 ... 110	1.000 ... 000 to 1.111 ... 111
	Negative Infinity ($-\infty$)	1	111 ... 111	1.000 ... 000
Negative Non-Numbers	SNaN	1	111 ... 111	1.000 ... 001 to 1.011 ... 111
	QNaN ³	1	111 ... 111	1.100 ... 000 to 1.111 ... 111

Notes:

1. The actual exponent field length is 8 or 11 bits, depending on operand precision.
2. The "1." and "0." prefixes represent the implicit integer bit. The actual fraction field length is 23 or 52 bits, depending on operand precision.
3. The floating-point indefinite value is a QNaN with a negative sign and a significand whose value is 1.100 ... 000.

Indefinite Values. Floating-point and integer data type each have a unique encoding that represents an *indefinite value*. The

processor returns an indefinite value when a masked invalid-operation exception (IE) occurs.

For example, if a floating-point division operation is attempted using source operands which are both zero, and IE exceptions are masked, the floating-point indefinite value is returned as the result. Or, if a floating-point-to-integer data conversion overflows its destination integer data type, and IE exceptions are masked, the integer indefinite value is returned as the result.

Table 4-8 shows the encodings of the indefinite values for each data type. For floating-point numbers, the indefinite value is a special form of QNaN. For integers, the indefinite value is the largest representable negative twos-complement number, 80...00h. (This value is interpreted as the largest representable negative number, except when a masked IE exception occurs, in which case it is interpreted as an indefinite value.)

Table 4-8. Indefinite-Value Encodings

Data Type	Indefinite Encoding
Floating-Point	<ul style="list-style-type: none"> • sign bit = 1 • biased exponent = 111 ... 111 • significand integer bit = 1 • significand fraction = 100 ... 000
Integer	<ul style="list-style-type: none"> • sign bit = 1 • integer = 000 ... 000

4.4.9 Floating-Point Rounding

Bits 14–13 of the MXCSR control and status register (“MXCSR Register” on page 144) comprise the floating-point rounding control (RC) field, which specifies how the results of floating-point computations are rounded. Rounding modes apply to most arithmetic operations. When rounding occurs, the processor generates a precision exception (PE). Rounding is not applied to operations that produce NaN results.

The IEEE 754 standard defines the four rounding modes as shown in Table 4-9 on page 163.

Table 4-9. Types of Rounding

RC Value	Mode	Type of Rounding
00 (default)	Round to nearest	The rounded result is the representable value closest to the infinitely precise result. If equally close, the even value (with least-significant bit 0) is taken.
01	Round down	The rounded result is closest to, but no greater than, the infinitely precise result.
10	Round up	The rounded result is closest to, but no less than, the infinitely precise result.
11	Round toward zero	The rounded result is closest to, but no greater in absolute value than, the infinitely precise result.

Round to nearest is the default rounding mode. It provides a statistically unbiased estimate of the true result, and is suitable for most applications. The other rounding modes are directed roundings: round up (toward $+\infty$), round down (toward $-\infty$), and round toward zero. Round up and round down are used in interval arithmetic, in which upper and lower bounds bracket the true result of a computation. Round toward zero takes the smaller in magnitude, that is, always truncates.

The processor produces a floating-point result defined by the IEEE standard to be infinitely precise. This result may not be representable exactly in the destination format, because only a subset of the continuum of real numbers finds exact representation in any particular floating-point format. Rounding modifies such a result to conform to the destination format, thereby making the result inexact and also generating a precision exception (PE), as described in “SIMD Floating-Point Exception Causes” on page 219.

Suppose, for example, the following 24-bit result is to be represented in single-precision format, where “ E_2 1010” represents the biased exponent:

1.0011 0101 0000 0001 0010 0111 E_2 1010

This result has no exact representation, because the least-significant 1 does not fit into the single-precision format, which allows for only 23 bits of fraction. The rounding control field determines the direction of rounding. Rounding introduces an error in a result that is less than one *unit in the last place* (*ulp*),

that is, the least-significant bit position of the floating-point representation.

4.5 Instruction Summary—Integer Instructions

This section summarizes functions of the integer instructions in the 128-bit media instruction subset. These include integer instructions that use an XMM register for source or destination and data-conversion instructions that convert from integers to floating-point formats. For a summary of the floating-point instructions in the 128-bit media instruction subset, including data-conversion instructions that convert from floating-point to integer formats, see “Instruction Summary—Floating-Point Instructions” on page 192.

The instructions are organized here by functional group—such as data-transfer, vector arithmetic, and so on. Software running at any privilege level can use any of these instructions, if the CPUID instruction reports support for the instructions (see “Feature Detection” on page 217). More detail on individual instructions is given in the alphabetically organized “128-Bit Media Instruction Reference” in Volume 4.

4.5.1 Syntax

Each instruction has a *mnemonic syntax* used by assemblers to specify the operation and the operands to be used for source and destination (result) data. The majority of 128-bit media integer instructions have the following syntax:

```
MNEMONIC xmm1, xmm2/mem128
```

Figure 4-16 shows an example of the mnemonic syntax for a packed add bytes (PADDB) instruction.

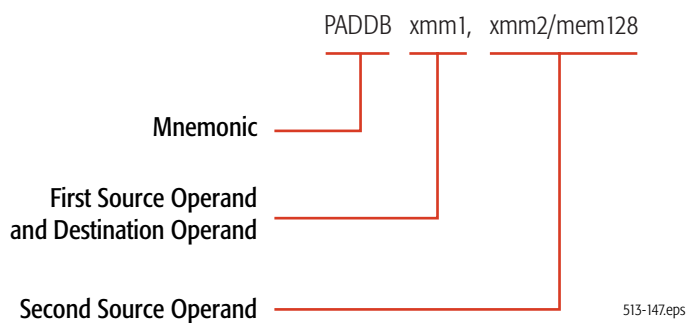

Figure 4-16. Mnemonic Syntax for Typical Instruction

This example shows the PADDB mnemonic followed by two operands, a 128-bit XMM register operand and another 128-bit XMM register or 128-bit memory operand. In most instructions that take two operands, the first (left-most) operand is both a source operand and the destination operand. The second (right-most) operand serves only as a source. Some instructions can have one or more prefixes that modify default properties, as described in “Instruction Prefixes” on page 216.

Mnemonics. The following characters are used as prefixes in the mnemonics of integer instructions:

- **CVT**—Convert
- **CVTT**—Convert with truncation
- **P**—Packed (vector)
- **PACK**—Pack elements of 2x data size to 1x data size
- **PUNPCK**—Unpack and interleave elements
- **UNPCK**—Unpack and interleave elements

In addition to the above prefix characters, the following characters are used elsewhere in the mnemonics of integer instructions:

- **B**—Byte
- **D**—Doubleword
- **DQ**—Double quadword
- **H**—High
- **L**—Low, or Left
- **PD**—Packed double-precision floating-point
- **PI**—Packed integer
- **PS**—Packed single-precision floating-point
- **Q**—Quadword
- **R**—Right
- **S**—Signed, or Saturation, or Shift
- **SD**—Scalar double-precision floating-point
- **SI**—Signed integer
- **SS**—Scalar single-precision floating-point, or Signed saturation
- **U**—Unsigned, or Unordered, or Unaligned
- **US**—Unsigned saturation

- **W**—Word
- **x**—One or more variable characters in the mnemonic

For example, the mnemonic for the instruction that packs four words into eight unsigned bytes is **PACKUSWB**. In this mnemonic, the **US** designates an unsigned result with saturation, and the **WB** designates the source as words and the result as bytes.

4.5.2 Data Transfer

The data-transfer instructions copy operands between a memory location, an **XMM** register, an **MMX** register, or a **GPR**. The **MOV** mnemonic, which stands for *move*, is a misnomer. A copy function is actually performed instead of a move. A new copy of the source value is created at the destination address, and the original copy remains unchanged at its source location.

Move.

- **MOVD**—Move Doubleword or Quadword
- **MOVQ**—Move Quadword
- **MOVDQA**—Move Aligned Double Quadword
- **MOVDQU**—Move Unaligned Double Quadword
- **MOVDQ2Q**—Move Quadword to Quadword
- **MOVQ2DQ**—Move Quadword to Quadword
- **LDDQU**—Load Double Quadword Unaligned

The **MOVD** instruction copies a 32-bit or 64-bit value from a **GPR** register or memory location to the low-order 32 or 64 bits of an **XMM** register, or from the low-order 32 or 64 bits of an **XMM** register to a 32-bit or 64-bit **GPR** or memory location. If the source operand is a **GPR** or memory location, the source is zero-extended to 128 bits in the **XMM** register. If the source is an **XMM** register, only the low-order 32 or 64 bits of the source are copied to the destination.

The **MOVQ** instruction copies a 64-bit value from memory to the low quadword of an **XMM** register, or from the low quadword of an **XMM** register to memory, or between the low quadwords of two **XMM** registers. If the source is in memory and the destination is an **XMM** register, the source is zero-extended to 128 bits in the **XMM** register.

The **MOVDQA** instruction copies a 128-bit value from memory to an **XMM** register, or from an **XMM** register to memory, or

between two XMM registers. If either the source or destination is a memory location, the memory address must be aligned. The MOVDQU instruction does the same, except for unaligned operands. The LDDQU instruction is virtually identical in operation to the MOVDQU instruction. The LDDQU instruction moves a double quadword of data from a 128-bit memory operand into a destination XMM register.

The MOVDQ2Q instruction copies the low-order 64-bit value in an XMM register to an MMX register. The MOVQ2DQ instruction copies a 64-bit value from an MMX register to the low-order 64 bits of an XMM register, with zero-extension to 128 bits.

Figure 4-17 on page 169 shows the capabilities of the various integer move instructions. These instructions move large amounts of data. When copying between XMM registers, or between an XMM register and memory, a move instruction can copy up to 16 bytes of data. When copying between an XMM register and an MMX or GPR register, a move instruction can copy up to 8 bytes of data. The MOV x instructions—along with the PUNPCK x instructions—are often among the most frequently used instructions in 128-bit media integer and floating-point procedures.

The move instructions are in many respects similar to the assignment operator in high-level languages. The simplest example of their use is for initializing variables. To initialize a register to 0, however, rather than using a MOV x instruction it may be more efficient to use the PXOR instruction with identical destination and source operands.

Move Non-Temporal. The move non-temporal instructions are *streaming-store* instructions. They minimize pollution of the cache.

- MOVNTDQ—Move Non-Temporal Double Quadword
- MASKMOVDQU—Masked Move Double Quadword Unaligned

The MOVNTDQ instruction stores its second operand (a 128-bit XMM register value) into its first operand (a 128-bit memory location). MOVNTDQ indicates to the processor that its data is *non-temporal*, which assumes that the referenced data will be used only once and is therefore not subject to cache-related overhead (as opposed to *temporal* data, which assumes that the

data will be accessed again soon and should be cached). The non-temporal instructions use weakly-ordered, write-combining buffering of write data, and they minimize cache pollution. The exact method by which cache pollution is minimized depends on the hardware implementation of the instruction. For further information, see “Memory Optimization” on page 115.

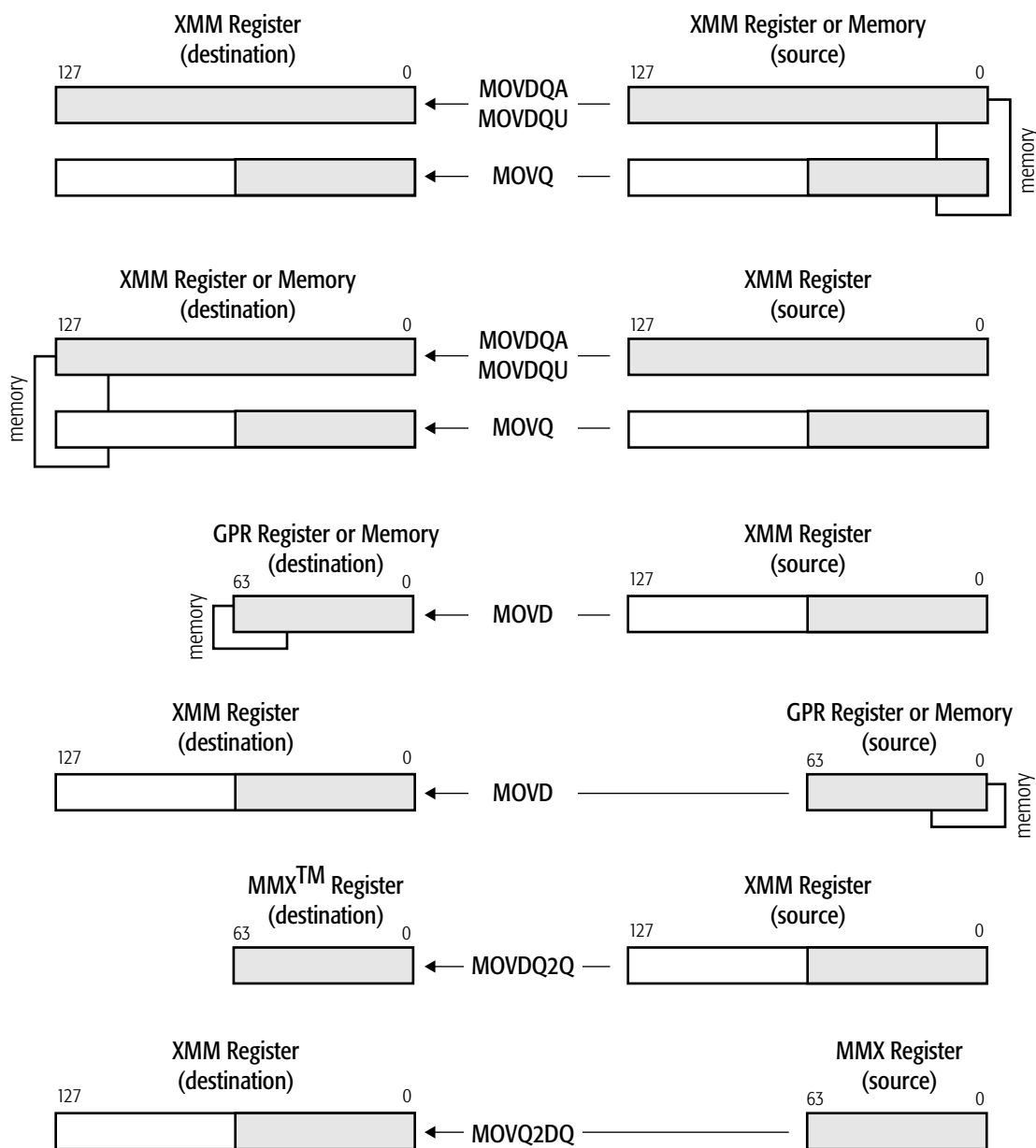

513-173.eps

Figure 4-17. Integer Move Operations

MASKMOVDQU is also a non-temporal instruction. It stores bytes from the first operand, as selected by the mask value in the second operand (0 = no write and 1 = write), to a memory location specified in the rDI and DS registers. The first and

second operands are both XMM registers. The address may be unaligned. Figure 4-18 shows the MASKMOVDQU operation. It is useful for the handling of end cases in block copies and block fills based on streaming stores.

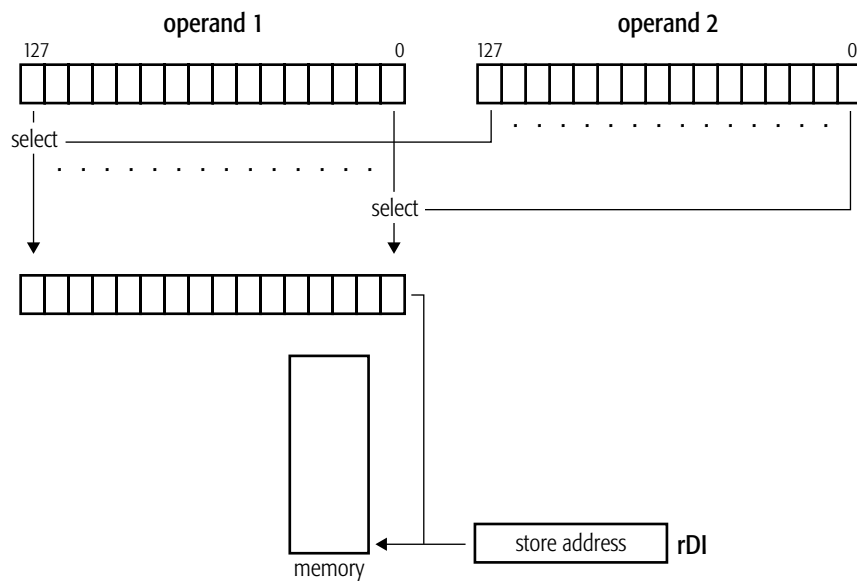

513-148.eps

Figure 4-18. MASKMOVDQU Move Mask Operation

Move Mask.

- PMOVMSKB—Packed Move Mask Byte

The PMOVMSKB instruction moves the most-significant bit of each byte in an XMM register to the low-order word of a 32-bit or 64-bit general-purpose register, with zero-extension. The instruction is useful for extracting bits from mask patterns, or zero values from quantized data, or sign bits—resulting in a byte that can be used for data-dependent branching. Figure 4-19 on page 171 shows the PMOVMSKB operation.

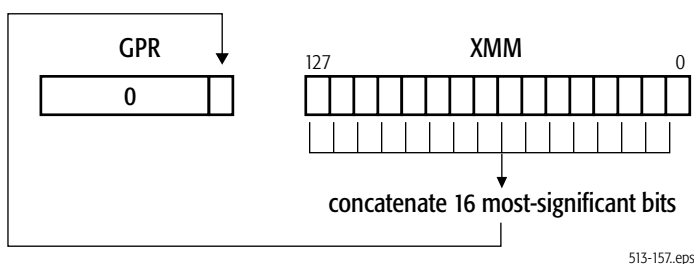

Figure 4-19. PMOVMSKB Move Mask Operation

4.5.3 Data Conversion

The integer data-conversion instructions convert integer operands to floating-point operands. These instructions take 128-bit integer source operands. For data-conversion instructions that take 128-bit floating-point source operands, see “Data Conversion” on page 197. For data-conversion instructions that take 64-bit source operands, see “Data Conversion” on page 258 and “Data Conversion” on page 274.

Convert Integer to Floating-Point. These instructions convert integer data types in XMM registers or memory into floating-point data types in XMM registers.

- CVTDQ2PS—Convert Packed Doubleword Integers to Packed Single-Precision Floating-Point
- CVTDQ2PD—Convert Packed Doubleword Integers to Packed Double-Precision Floating-Point

The CVTDQ2PS instruction converts four 32-bit signed integer values in the second operand to four single-precision floating-point values and writes the converted values in another XMM register. If the result of the conversion is an inexact value, the value is rounded. The CVTDQ2PD instruction is analogous to CVTDQ2PS except that it converts two 64-bit signed integer values to two double-precision floating-point values.

Convert MMX Integer to Floating-Point. These instructions convert integer data types in MMX registers or memory into floating-point data types in XMM registers.

- CVTPI2PS—Convert Packed Doubleword Integers to Packed Single-Precision Floating-Point

- **CVTPI2PD—Convert Packed Doubleword Integers to Packed Double-Precision Floating-Point**

The CVTPI2PS instruction converts two 32-bit signed integer values in an MMX register or a 64-bit memory location to two single-precision floating-point values and writes the converted values in the low-order 64 bits of an XMM register. The high-order 64 bits of the XMM register are not modified.

The CVTPI2PD instruction is analogous to CVTPI2PS except that it converts two 32-bit signed integer values to two double-precision floating-point values and writes the converted values in the full 128 bits of an XMM register.

Before executing a CVTPI2 x instruction, software should ensure that the MMX registers are properly initialized so as to prevent conflict with their aliased use by x87 floating-point instructions. This may require clearing the MMX state, as described in “Accessing Operands in MMX™ Registers” on page 231.

For a description of 128-bit media instructions that convert in the opposite direction—floating-point to integer in MMX registers—see “Convert Floating-Point to MMX™ Integer” on page 199. For a summary of instructions that operate on MMX registers, see Chapter 5, “64-Bit Media Programming.”

Convert GPR Integer to Floating-Point. These instructions convert integer data types in GPR registers or memory into floating-point data types in XMM registers.

- **CVTSI2SS—Convert Signed Doubleword or Quadword Integer to Scalar Single-Precision Floating-Point**
- **CVTSI2SD—Convert Signed Doubleword or Quadword Integer to Scalar Double-Precision Floating-Point**

The CVTSI2SS instruction converts a 32-bit or 64-bit signed integer value in a general-purpose register or memory location to a single-precision floating-point value and writes the converted value in the low-order 32 bits of an XMM register. The three high-order doublewords in the destination XMM register are not modified.

The CVTSI2SD instruction converts a 32-bit or 64-bit signed integer value in a general-purpose register or memory location to a double-precision floating-point value and writes the converted value in the low-order 64 bits of an XMM register.

The high-order 64 bits in the destination XMM register are not modified.

4.5.4 Data Reordering

The integer data-reordering instructions pack, unpack, interleave, extract, insert, and shuffle the elements of vector operands.

Pack with Saturation. These instructions pack larger data types into smaller data types, thus halving the precision of each element in a vector operand.

- **PACKSSDW**—Pack with Saturation Signed Doubleword to Word
- **PACKSSWB**—Pack with Saturation Signed Word to Byte
- **PACKUSWB**—Pack with Saturation Signed Word to Unsigned Byte

The **PACKSSDW** instruction converts each of the four signed doubleword integers in its two source operands (an XMM register, and another XMM register or 128-bit memory location) into signed word integers and packs the converted values into the destination operand (an XMM register). The **PACKSSWB** instruction does the analogous conversion between word elements in the source vectors and byte elements in the destination vector. The **PACKUSWB** instruction does the same as **PACKSSWB** except that it converts signed word integers into unsigned (rather than signed) bytes.

Figure 4-20 on page 174 shows an example of a **PACKSSDW** instruction. The operation merges vector elements of 2x size into vector elements of 1x size, thus reducing the precision of the vector-element data types. Any results that would otherwise overflow or underflow are saturated (clamped) at the maximum or minimum representable value, respectively, as described in “Saturation” on page 153.

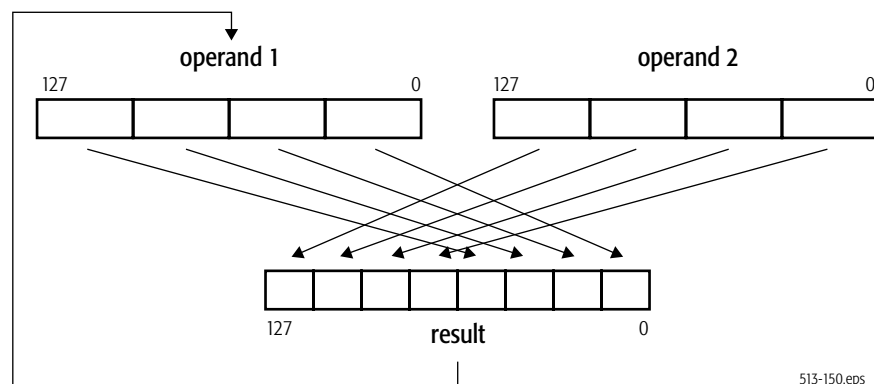

Figure 4-20. PACKSSDW Pack Operation

Conversion from higher-to-lower precision is often needed, for example, by multiplication operations in which the higher-precision format is used for source operands in order to prevent possible overflow, and the lower-precision format is the desired format for the next operation.

Unpack and Interleave. These instructions interleave vector elements from the high or low halves of two integer source operands. They can be used to double the precision of operands.

- PUNPCKHBW—Unpack and Interleave High Bytes
- PUNPCKHWD—Unpack and Interleave High Words
- PUNPCKHDQ—Unpack and Interleave High Doublewords
- PUNPCKHQDQ—Unpack and Interleave High Quadwords
- PUNPCKLBW—Unpack and Interleave Low Bytes
- PUNPCKLWD—Unpack and Interleave Low Words
- PUNPCKLDQ—Unpack and Interleave Low Doublewords
- PUNPCKLQDQ—Unpack and Interleave Low Quadwords

The PUNPCKHBW instruction copies the eight high-order bytes from its two source operands (an XMM register, and another XMM register or 128-bit memory location) and interleaves them into the 128-bit destination operand (an XMM register). The bytes in the low-order half of the source operands are ignored. The PUNPCKHWD, PUNPCKHDQ, and PUNPCKHQDQ instructions perform analogous operations for

words, doublewords, and quadwords in the source operands, packing them into interleaved words, interleaved doublewords, and interleaved quadwords in the destination operand.

The PUNPCKLBW, PUNPCKLWD, PUNPCKLDQ, and PUNPCKLQDQ instructions are analogous to their high-element counterparts except that they take elements from the low quadword of each source vector and ignore elements in the high quadword. Depending on the hardware implementation, if the source operand for PUNPCKLx and PUNPCKHx instructions is in memory, only the low 64 bits of the operand may be loaded.

Figure 4-21 shows an example of the PUNPCKLWD instruction. The elements are taken from the low half of the source operands. In this register image, elements from *operand2* are placed to the left of elements from *operand1*.

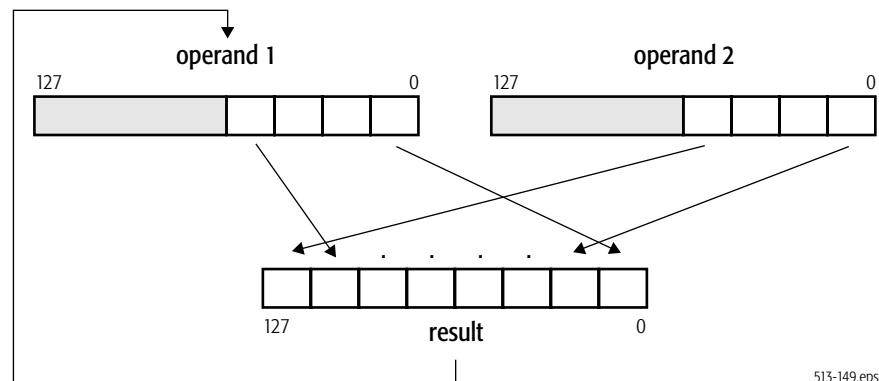

Figure 4-21. PUNPCKLWD Unpack and Interleave Operation

If operand 2 is a vector consisting of all zero-valued elements, the unpack instructions perform the function of expanding vector elements of 1x size into vector elements of 2x size. Conversion from lower-to-higher precision is often needed, for example, prior to multiplication operations in which the higher-precision format is used for source operands in order to prevent possible overflow during multiplication.

If both source operands are of identical value, the unpack instructions can perform the function of duplicating adjacent elements in a vector.

The PUNPCK x instructions can be used in a repeating sequence to transpose rows and columns of an array. For example, such a sequence could begin with PUNPCK x WD and be followed by PUNPCK x QD. These instructions can also be used to convert pixel representation from RGB format to color-plane format, or to interleave interpolation elements into a vector.

As noted above, and depending on the hardware implementation, the width of the memory access performed by the memory-operand forms of PUNPCKLBW, PUNPCKLWD, PUNPCKLDQ, and PUNPCKLQDQ may be 64 bits, but the width of the memory access of the memory-operand forms of PUNPCKHBW, PUNPCKHWD, PUNPCKHDQ, and PUNPCKHQDQ may be 128 bits. Thus, the alignment constraints for PUNPCKL x instructions may be less restrictive than the alignment constraints for PUNPCKH x instructions. For details, see the documentation for particular hardware implementations of the architecture.

Another advantage of using PUNPCKL x rather than PUNPCKH x —also depending on the hardware implementation—is that it may help avoid potential size mismatches if a particular hardware implementation uses load-to-store forwarding. In such cases, store data from either a quadword store or the lower quadword of a double-quadword store could be forwarded to PUNPCKL x instructions, but only store data from a double-quadword store could be forwarded to PUNPCKH x instructions.

The PUNPCK x instructions—along with the MOV x instructions—are often among the most frequently used instructions in 128-bit media integer and floating-point procedures.

Extract and Insert. These instructions copy a word element from a vector, in a manner specified by an immediate operand.

- PEXTRW—Packed Extract Word
- PINSRW—Packed Insert Word

The PEXTRW instruction extracts a 16-bit value from an XMM register, as selected by the immediate-byte operand, and writes it to the low-order word of a 32-bit or 64-bit general-purpose register, with zero-extension to 32 or 64 bits. PEXTRW is useful for loading computed values, such as table-lookup indices, into

general-purpose registers where the values can be used for addressing tables in memory.

The PINSRW instruction inserts a 16-bit value from the low-order word of a general-purpose register or from a 16-bit memory location into an XMM register. The location in the destination register is selected by the immediate-byte operand. The other words in the destination register operand are not modified. Figure 4-22 shows the operation.

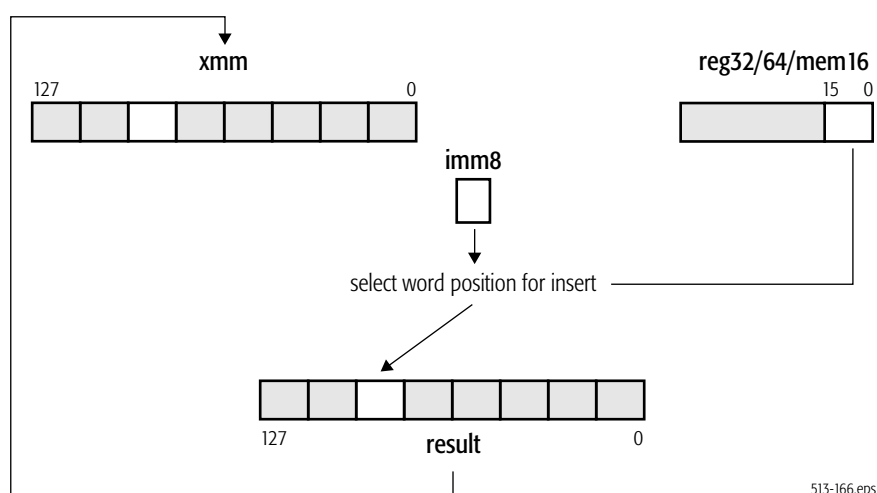

513-166.eps

Figure 4-22. PINSRW Operation

Shuffle. These instructions reorder the elements of a vector.

- PSHUFD—Packed Shuffle Doublewords
- PSHUFHW—Packed Shuffle High Words
- PSHUFLW—Packed Shuffle Low Words

The PSHUFD instruction fills each doubleword of the first operand (an XMM register) by copying any one of the doublewords in the second operand (an XMM register or 128-bit memory location). The ordering of the shuffle can occur in one of 256 possible ways, as specified by the third operand, an immediate byte. Figure 4-23 on page 178 shows one of the 256 possible shuffle operations.

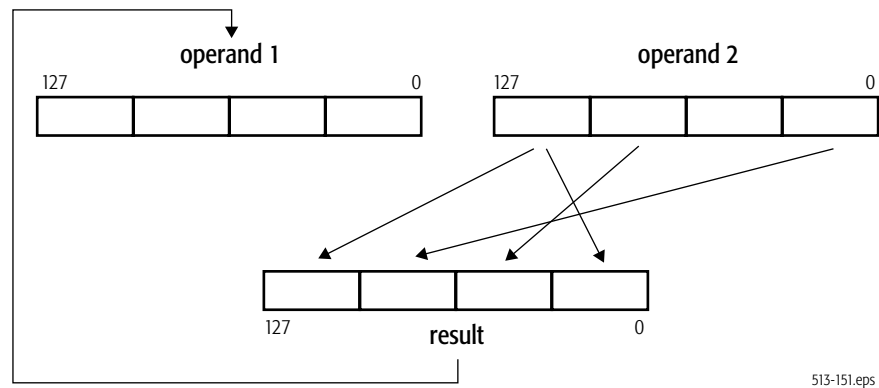

Figure 4-23. PSHUFD Shuffle Operation

The PSHUFHW and PSHUFLW instructions are analogous to PSHUFD, except that they fill each word of the high or low quadword, respectively, of the first operand by copying any one of the four words in the high or low quadword of the second operand. Figure 4-24 shows the PSHUFHW operation. PSHUFHW and PSHUFLW are useful, for example, in color imaging when computing alpha saturation of RGB values. In this case, PSHUFxW can replicate an alpha value in a register so that parallel comparisons with three RGB values can be performed.

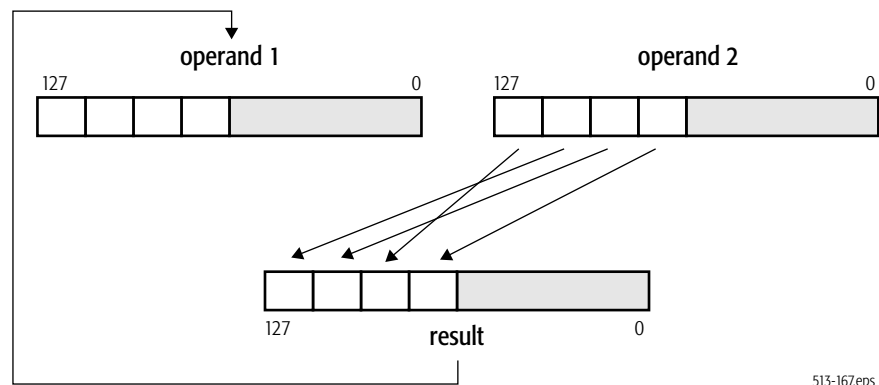
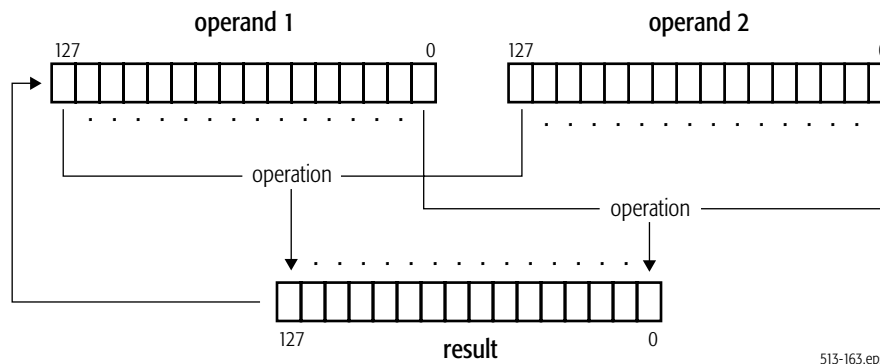

Figure 4-24. PSHUFHW Shuffle Operation

4.5.5 Arithmetic

The integer vector-arithmetic instructions perform an arithmetic operation on the elements of two source vectors. Figure 4-25 shows a typical arithmetic operation on vectors of bytes. Such instructions performs 16 arithmetic operations in parallel.



513-163.eps

Figure 4-25. Arithmetic Operation on Vectors of Bytes

Addition.

- PADDDB—Packed Add Bytes
- PADDW—Packed Add Words
- PADDD—Packed Add Doublewords
- PADDQ—Packed Add Quadwords
- PADDSB—Packed Add with Saturation Bytes
- PADDSW—Packed Add with Saturation Words
- PADDUSB—Packed Add Unsigned with Saturation Bytes
- PADDUSW—Packed Add Unsigned with Saturation Words

The PADDDB, PADDW, PADDD, and PADDQ instructions add each packed 8-bit (PADDDB), 16-bit (PADDW), 32-bit (PADDD), or 64-bit (PADDQ) integer element in the second operand to the corresponding, same-sized integer element in the first operand and write the integer result to the corresponding, same-sized element of the destination. Figure 4-25 shows a PADDDB operation. These instructions operate on both signed and unsigned integers. However, if the result overflows, the carry is ignored and only the low-order byte, word, doubleword, or quadword of each result is written to the destination. The

PADD instruction can be used together with PMADDWD (page 183) to implement dot products.

The PADD SB and PADD SW instructions add each 8-bit (PADD SB) or 16-bit (PADD SW) signed integer element in the second operand to the corresponding, same-sized signed integer element in the first operand and write the signed integer result to the corresponding, same-sized element of the destination. For each result in the destination, if the result is larger than the largest, or smaller than the smallest, representable 8-bit (PADD SB) or 16-bit (PADD SW) signed integer, the result is saturated to the largest or smallest representable value, respectively.

The PADD USB and PADD USW instructions perform saturating-add operations analogous to the PADD SB and PADD SW instructions, except on unsigned integer elements.

Subtraction.

- PSUBB—Packed Subtract Bytes
- PSUBW—Packed Subtract Words
- PSUBD—Packed Subtract Doublewords
- PSUBQ—Packed Subtract Quadword
- PSUB SB—Packed Subtract with Saturation Bytes
- PSUB SW—Packed Subtract with Saturation Words
- PSUB USB—Packed Subtract Unsigned and Saturate Bytes
- PSUB USW—Packed Subtract Unsigned and Saturate Words

The subtraction instructions perform operations analogous to the addition instructions.

The PSUBB, PSUBW, PSUBD, and PSUBQ instructions subtract each 8-bit (PSUBB), 16-bit (PSUBW), 32-bit (PSUBD), or 64-bit (PSUBQ) integer element in the second operand from the corresponding, same-sized integer element in the first operand and write the integer result to the corresponding, same-sized element of the destination. For vectors of n number of elements, the operation is:

$$\text{operand1}[i] = \text{operand1}[i] - \text{operand2}[i]$$

where: $i = 0$ to $n - 1$

These instructions operate on both signed and unsigned integers. However, if the result underflows, the borrow is

ignored and only the low-order byte, word, doubleword, or quadword of each result is written to the destination.

The PSUBSB and PSUBSW instructions subtract each 8-bit (PSUBSB) or 16-bit (PSUBSW) signed integer element in the second operand from the corresponding, same-sized signed integer element in the first operand and write the signed integer result to the corresponding, same-sized element of the destination. For each result in the destination, if the result is larger than the largest, or smaller than the smallest, representable 8-bit (PSUBSB) or 16-bit (PSUBSW) signed integer, the result is saturated to the largest or smallest representable value, respectively.

The PSUBUSB and PSUBUSW instructions perform saturating-add operations analogous to the PSUBSB and PSUBSW instructions, except on unsigned integer elements.

Multiplication.

- PMULHW—Packed Multiply High Signed Word
- PMULLW—Packed Multiply Low Signed Word
- PMULHUW—Packed Multiply High Unsigned Word
- PMULUDQ—Packed Multiply Unsigned Doubleword and Store Quadword

The PMULHW instruction multiplies each 16-bit signed integer value in the first operand by the corresponding 16-bit integer in the second operand, producing a 32-bit intermediate result. The instruction then writes the high-order 16 bits of the 32-bit intermediate result of each multiplication to the corresponding word of the destination. The PMULLW instruction performs the same multiplication as PMULHW but writes the low-order 16 bits of the 32-bit intermediate result to the corresponding word of the destination.

Figure 4-26 on page 182 shows the PMULHW and PMULLW operations. The difference between the two is whether the high or low half of each intermediate-element result is copied to the destination result.

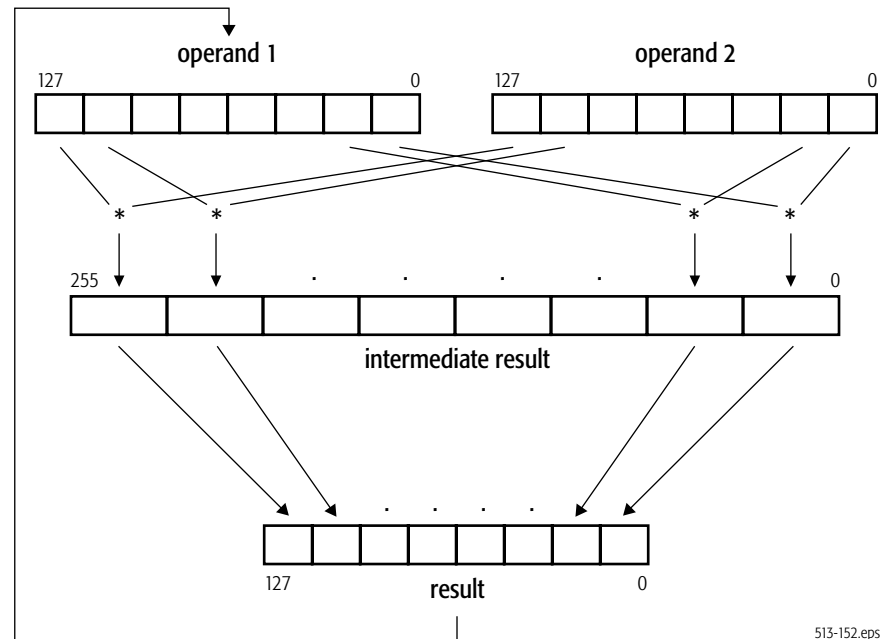

513-152.eps

Figure 4-26. PMULxW Multiply Operation

The PMULHUW instruction performs the same multiplication as PMULHW but on unsigned operands. Without this instruction, it is difficult to perform unsigned integer multiplies using 128-bit media instructions. The instruction is useful in 3D rasterization, which operates on unsigned pixel values.

The PMULUDQ instruction, unlike the other PMULx instructions, preserves the full precision of results by multiplying only half of the source-vector elements. It multiplies the 32-bit unsigned integer values in the first (low-order) and third doublewords of the source operands, writes the full 64-bit result of the low-order multiply to the low-order doubleword of the destination, and writes a corresponding result of the high-order multiply to the high-order doubleword of the destination. Figure 4-27 on page 183 shows a PMULUDQ operation.

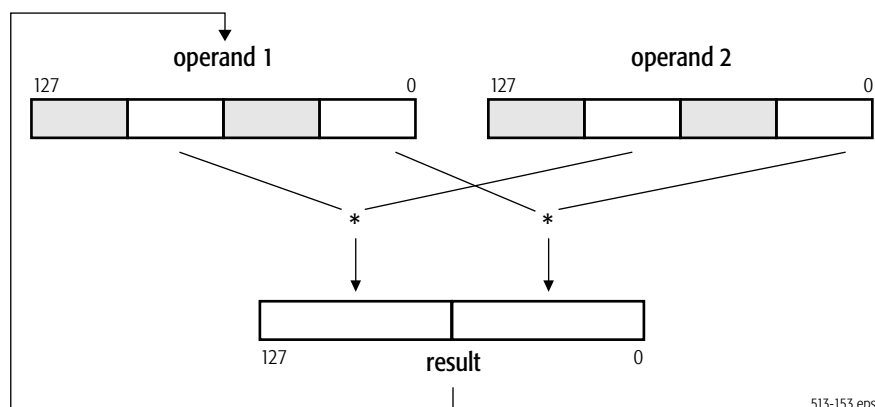

513-153.eps

Figure 4-27. PMULUDQ Multiply Operation

See “Shift” on page 186 for shift instructions that can be used to perform multiplication and division by powers of 2.

Multiply-Add. This instruction multiplies the elements of two source vectors and add their intermediate results in a single operation.

- **PMADDWD—Packed Multiply Words and Add Doublewords**

The PMADDWD instruction multiplies each 16-bit signed value in the first operand by the corresponding 16-bit signed value in the second operand. The instruction then adds the adjacent 32-bit intermediate results of each multiplication, and writes the 32-bit result of each addition into the corresponding doubleword of the destination. For vectors of n number of source elements (src), m number of destination elements (dst), and $n = 2m$, the operation is:

$$\text{dst}[j] = ((\text{src1}[i] * \text{src2}[i]) + (\text{src1}[i+1] * \text{src2}[i+1]))$$

where: $i = 0$ to $n - 1$

$$i = 2j$$

PMADDWD thus performs four signed multiply-adds in parallel. Figure 4-28 on page 184 shows the operation.

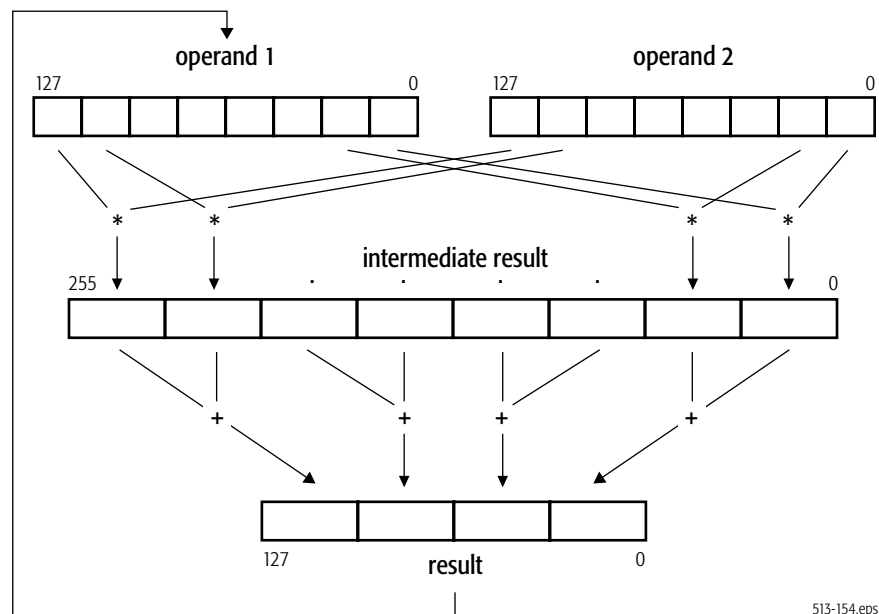

513-154.eps

Figure 4-28. PMADDWD Multiply-Add Operation

PMADDWD can be used with one source operand (for example, a coefficient) taken from memory and the other source operand (for example, the data to be multiplied by that coefficient) taken from an XMM register. The instruction can also be used together with the PADD instruction (page 179) to compute dot products. Scaling can be done, before or after the multiply, using a vector-shift instruction (page 186).

If all four of the 16-bit source operands used to produce a 32-bit multiply-add result have the value 8000h, the result is represented as 8000_0000h, because the maximum negative 16-bit value of 8000h multiplied by itself equals 4000_0000h, and 4000_0000h added to 4000_0000h equals 8000_0000h. The result of multiplying two negative numbers should be a positive number, but 8000_0000h is the maximum possible 32-bit negative number rather than a positive number.

Average.

- PAVGB—Packed Average Unsigned Bytes
- PAVGW—Packed Average Unsigned Words

The PAVGx instructions compute the rounded average of each unsigned 8-bit (PAVGB) or 16-bit (PAVGW) integer value in the first operand and the corresponding, same-sized unsigned integer in the second operand and write the result in the corresponding, same-sized element of the destination. The rounded average is computed by adding each pair of operands, adding 1 to the temporary sum, and then right-shifting the temporary sum by one bit-position. For vectors of n number of elements, the operation is:

$$\text{operand1}[i] = ((\text{operand1}[i] + \text{operand2}[i]) + 1) \div 2$$

where: $i = 0$ to $n - 1$

The PAVGB instruction is useful for MPEG decoding, in which motion compensation performs many byte-averaging operations between and within macroblocks. In addition to speeding up these operations, PAVGB can free up registers and make it possible to unroll the averaging loops.

Sum of Absolute Differences.

- PSADBW—Packed Sum of Absolute Differences of Bytes into a Word

The PSADBW instruction computes the absolute values of the differences of corresponding 8-bit signed integer values in the two quadword halves of both source operands, sums the differences for each quadword half, and writes the two unsigned 16-bit integer results in the destination. The sum for the high-order half is written in the least-significant word of the destination's high-order quadword, with the remaining bytes cleared to all 0s. The sum for the low-order half is written in the least-significant word of the destination's low-order quadword, with the remaining bytes cleared to all 0s.

Figure 4-29 on page 186 shows the PSADBW operation. Sums of absolute differences are useful, for example, in computing the L1 norm in motion-estimation algorithms for video compression.

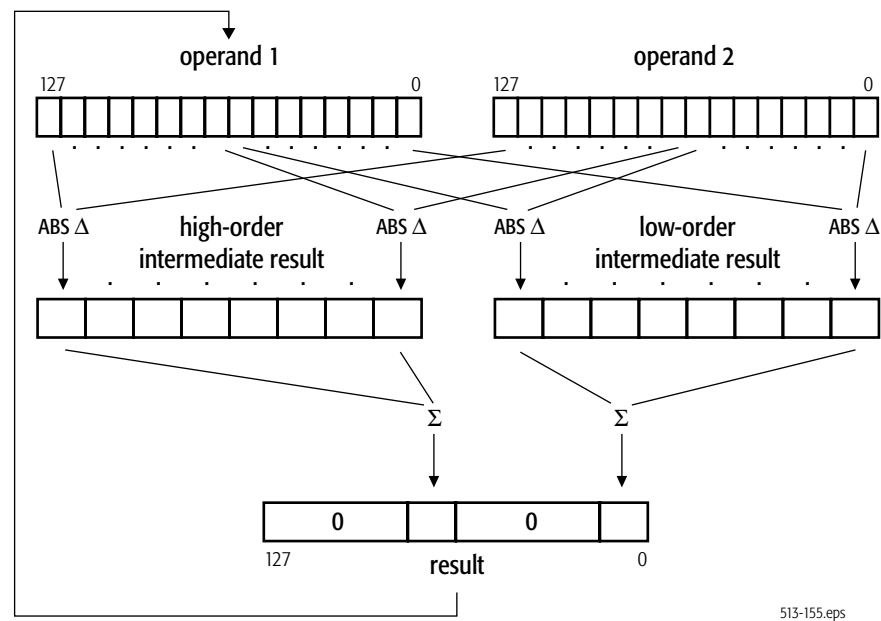

513-155.eps

Figure 4-29. PSADBW Sum-of-Absolute-Differences Operation

4.5.6 Shift

The vector-shift instructions are useful for scaling vector elements to higher or lower precision, packing and unpacking vector elements, and multiplying and dividing vector elements by powers of 2.

Left Logical Shift.

- PSSLW—Packed Shift Left Logical Words
- PSLLD—Packed Shift Left Logical Doublewords
- PSLLQ—Packed Shift Left Logical Quadwords
- PSLLDQ—Packed Shift Left Logical Double Quadword

The PSSLW, PSLLD, and PSLLQ instructions left-shift each of the 16-bit, 32-bit, or 64-bit values, respectively, in the first operand by the number of bits specified in the second operand. The instructions then write each shifted value into the corresponding, same-sized element of the destination. The low-order bits that are emptied by the shift operation are cleared to 0. The first operand is an XMM register. The second operand can be an XMM register, 128-bit memory location, or immediate byte.

In integer arithmetic, left logical shifts effectively multiply unsigned operands by positive powers of 2. Thus, For vectors of n number of elements, the operation is:

$$\text{operand1}[i] = \text{operand1}[i] * 2^{\text{operand2}}$$

where: $i = 0$ to $n - 1$

The PSLLDQ instruction differs from the other three left-shift instructions because it operates on bytes rather than bits. It left-shifts the 128-bit (double quadword) value in an XMM register by the number of bytes specified in an immediate byte value.

Right Logical Shift.

- PSRLW—Packed Shift Right Logical Words
- PSRLD—Packed Shift Right Logical Doublewords
- PSRLQ—Packed Shift Right Logical Quadwords
- PSRLDQ—Packed Shift Right Logical Double Quadword

The PSRLW, PSRLD, and PSRLQ instructions right-shift each of the 16-bit, 32-bit, or 64-bit values, respectively, in the first operand by the number of bits specified in the second operand. The instructions then write each shifted value into the corresponding, same-sized element of the destination. The high-order bits that are emptied by the shift operation are cleared to 0. The first operand is an XMM register. The second operand can be an XMM register, 128-bit memory location, or immediate byte.

In integer arithmetic, right logical bit-shifts effectively divide unsigned operands by positive powers of 2, or they divide positive signed operands by positive powers of 2. Thus, For vectors of n number of elements, the operation is:

$$\text{operand1}[i] = \text{operand1}[i] \div 2^{\text{operand2}}$$

where: $i = 0$ to $n - 1$

The PSRLDQ instruction differs from the other three right-shift instructions because it operates on bytes rather than bits. It right-shifts the 128-bit (double quadword) value in an XMM register by the number of bytes specified in an immediate byte value. PSRLDQ can be used, for example, to move the high 8 bytes of an XMM register to the low 8 bytes of the register. In

some implementations, however, PUNPCKHQDQ may be a better choice for this operation.

Right Arithmetic Shift.

- PSRAW—Packed Shift Right Arithmetic Words
- PSRAD—Packed Shift Right Arithmetic Doublewords

The PSRAx instructions right-shift each of the 16-bit (PSRAW) or 32-bit (PSRAD) values in the first operand by the number of bits specified in the second operand. The instructions then write each shifted value into the corresponding, same-sized element of the destination. The high-order bits that are emptied by the shift operation are filled with the sign bit of the initial value.

In integer arithmetic, right arithmetic shifts effectively divide signed operands by positive powers of 2. Thus, For vectors of n number of elements, the operation is:

$$\text{operand1}[i] = \text{operand1}[i] \div 2^{\text{operand2}}$$

where: $i = 0$ to $n - 1$

4.5.7 Compare

The integer vector-compare instructions compare two operands, and they either write a mask or they write the maximum or minimum value.

Compare and Write Mask.

- PCMPEQB—Packed Compare Equal Bytes
- PCMPEQW—Packed Compare Equal Words
- PCMPEQD—Packed Compare Equal Doublewords
- PCMPGTB—Packed Compare Greater Than Signed Bytes
- PCMPGTW—Packed Compare Greater Than Signed Words
- PCMPGTD—Packed Compare Greater Than Signed Doublewords

The PCMPEQx and PCMPGTx instructions compare corresponding bytes, words, or doublewords in the two source operands. The instructions then write a mask of all 1s or 0s for each compare into the corresponding, same-sized element of the destination. Figure 4-30 on page 189 shows a PCMPEQB compare operation. It performs 16 compares in parallel.

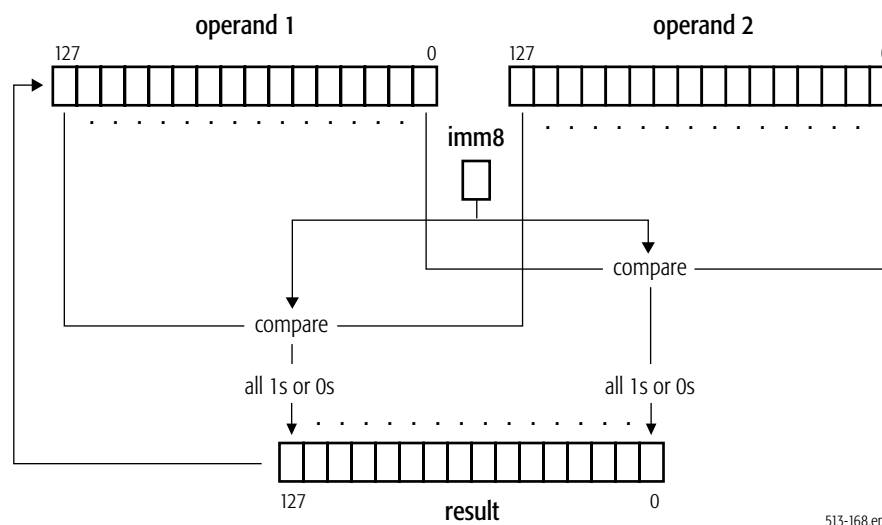

513-168.eps

Figure 4-30. PCMPEQB Compare Operation

For the PCMPEQx instructions, if the compared values are equal, the result mask is all 1s. If the values are not equal, the result mask is all 0s. For the PCMPGTx instructions, if the signed value in the first operand is greater than the signed value in the second operand, the result mask is all 1s. If the value in the first operand is less than or equal to the value in the second operand, the result mask is all 0s.

By specifying the same register for both operands, PCMPEQx can be used to set the bits in an XMM register to all 1s.

Figure 4-10 on page 142 shows an example of a non-branching sequence that implements a two-way multiplexer—one that is equivalent to the following sequence of ternary operators in C or C++:

```

r0 = a0 > b0 ? a0 : b0
r1 = a1 > b1 ? a1 : b1
r2 = a2 > b2 ? a2 : b2
r3 = a3 > b3 ? a3 : b3
r4 = a4 > b4 ? a4 : b4
r5 = a5 > b5 ? a5 : b5
r6 = a6 > b6 ? a6 : b6
r7 = a7 > b7 ? a7 : b7

```

Assuming `xmm0` contains the vector `a`, and `xmm1` contains the vector `b`, the above C sequence can be implemented with the following assembler sequence:

```
MOVQ    xmm3, xmm0
PCMPGTW xmm3, xmm2 ; a > b ? 0xffff : 0
PAND    xmm0, xmm3 ; a > b ? a : 0
PANDN   xmm3, xmm1 ; a > b > 0 : b
POR     xmm0, xmm3 ; r = a > b ? a : b
```

In the above sequence, `PCMPGTW`, `PAND`, `PANDN`, and `POR` operate, in parallel, on all four elements of the vectors.

Compare and Write Minimum or Maximum.

- `PMAXUB`—Packed Maximum Unsigned Bytes
- `PMINUB`—Packed Minimum Unsigned Bytes
- `PMAXSW`—Packed Maximum Signed Words
- `PMINSW`—Packed Minimum Signed Words

The `PMAXUB` and `PMINUB` instructions compare each of the 8-bit unsigned integer values in the first operand with the corresponding 8-bit unsigned integer values in the second operand. The instructions then write the maximum (`PMAXUB`) or minimum (`PMINUB`) of the two values for each comparison into the corresponding byte of the destination.

The `PMAXSW` and `PMINSW` instructions perform operations analogous to the `PMAXUB` and `PMINUB` instructions, except on 16-bit signed integer values.

4.5.8 Logical

The vector-logic instructions perform Boolean logic operations, including `AND`, `OR`, and exclusive `OR`.

And.

- `PAND`—Packed Logical Bitwise AND
- `PANDN`—Packed Logical Bitwise AND NOT

The `PAND` instruction performs a logical bitwise AND of the values in the first and second operands and writes the result to the destination.

The `PANDN` instruction inverts the first operand (creating a ones-complement of the operand), ANDs it with the second operand, and writes the result to the destination. Table 4-10 on page 191 shows an example.

Table 4-10. Example PANDN Bit Values

Operand1 Bit	Operand1 Bit (Inverted)	Operand2 Bit	PANDN Result Bit
1	0	1	0
1	0	0	0
0	1	1	1
0	1	0	0

Or.

- **POR**—Packed Logical Bitwise OR

The POR instruction performs a logical bitwise OR of the values in the first and second operands and writes the result to the destination.

Exclusive Or.

- **PXOR**—Packed Logical Bitwise Exclusive OR

The PXOR instruction performs a logical bitwise exclusive OR of the values in the first and second operands and writes the result to the destination. PXOR can be used to clear all bits in an XMM register by specifying the same register for both operands.

4.5.9 **Save and Restore State**

These instructions save and restore the entire processor state for 128-bit media instructions.

Save and Restore 128-Bit, 64-Bit, and x87 State.

- **FXSAVE**—Save XMM, MMX, and x87 State.
- **FXRSTOR**—Restore XMM, MMX, and x87 State.

The FXSAVE and FXRSTOR instructions save and restore the entire 512-byte processor state for 128-bit media instructions, 64-bit media instructions, and x87 floating-point instructions. The architecture supports two memory formats for FXSAVE and FXRSTOR, a 512-byte 32-bit legacy format and a 512-byte 64-bit format. Selection of the 32-bit or 64-bit format is determined by the effective operand size for the FXSAVE and FXRSTOR instructions. For details, see “Saving Media and x87 Processor State” in Volume 2.

Save and Restore Control and Status.

- STMXCSR—Store MXCSR Control/Status Register
- LDMXCSR—Load MXCSR Control/Status Register

The STMXCSR and LDMXCSR instructions save and restore the 32-bit contents of the MXCSR register. For further information, see “MXCSR Register” on page 144.

4.6 Instruction Summary—Floating-Point Instructions

This section summarizes the functions of the floating-point instructions in the 128-bit media instruction subset. These include floating-point instructions that use an XMM register for source or destination and data-conversion instructions that convert from floating-point to integers formats. For a summary of the integer instructions in the 128-bit media instruction subset, including data-conversion instructions that convert from integer to floating-point formats, see “Instruction Summary—Integer Instructions” on page 164.

For a summary of the 64-bit media floating-point instructions, see “Instruction Summary—Floating-Point Instructions” on page 273. For a summary of the x87 floating-point instructions, see “Instruction Summary” on page 323.

The instructions are organized here by functional group—such as data-transfer, vector arithmetic, and so on. Software running at any privilege level can use any of these instructions, if the CPUID instruction reports support for the instructions (see “Feature Detection” on page 217). More detail on individual instructions is given in the alphabetically organized “128-Bit Media Instruction Reference” on page 1.

4.6.1 Syntax

The 128-bit media floating-point instructions have the same syntax rules as those for the 128-bit media integer instructions, described in “Syntax” on page 164. For an illustration of typical syntax, see Figure 4-16 on page 164.

4.6.2 Data Transfer

The data-transfer instructions copy operands between 32-bit, 64-bit, or 128-bit memory locations and XMM registers. The MOV mnemonic, which stands for *move*, is a misnomer. A copy function is actually performed instead of a move. A new copy of the source value is created at the destination address, and the original copy remains unchanged at its source location.

Move.

- MOVAPS—Move Aligned Packed Single-Precision Floating-Point
- MOVAPD—Move Aligned Packed Double-Precision Floating-Point
- MOVUPS—Move Unaligned Packed Single-Precision Floating-Point
- MOVUPD—Move Unaligned Packed Double-Precision Floating-Point
- MOVHPS—Move High Packed Single-Precision Floating-Point
- MOVHPD—Move High Packed Double-Precision Floating-Point
- MOVLPS—Move Low Packed Single-Precision Floating-Point
- MOVLPD—Move Low Packed Double-Precision Floating-Point
- MOVHLPS—Move Packed Single-Precision Floating-Point High to Low
- MOVLHPS—Move Packed Single-Precision Floating-Point Low to High
- MOVSS—Move Scalar Single-Precision Floating-Point
- MOVSD—Move Scalar Double-Precision Floating-Point
- MOVDDUP—Move Double-Precision and Duplicate
- MOVSLDUP—Move Single-Precision High and Duplicate
- MOVSHDUP—Move Single-Precision Low and Duplicate

Figure 4-31 on page 194 shows the capabilities of the various floating-point move instructions.

The MOVAPx instructions copy a vector of four single-precision floating-point values (MOVAPS) or a vector of two double-precision floating-point values (MOVAPD) from the second operand to the first operand—i.e., from an XMM register or 128-bit memory location or to another XMM register, or vice versa. A general-protection exception occurs if a memory operand is not aligned on a 16-byte boundary.

The MOVUPx instructions perform operations analogous to the MOVAPx instructions, except that unaligned memory operands do not cause a general-protection exception.

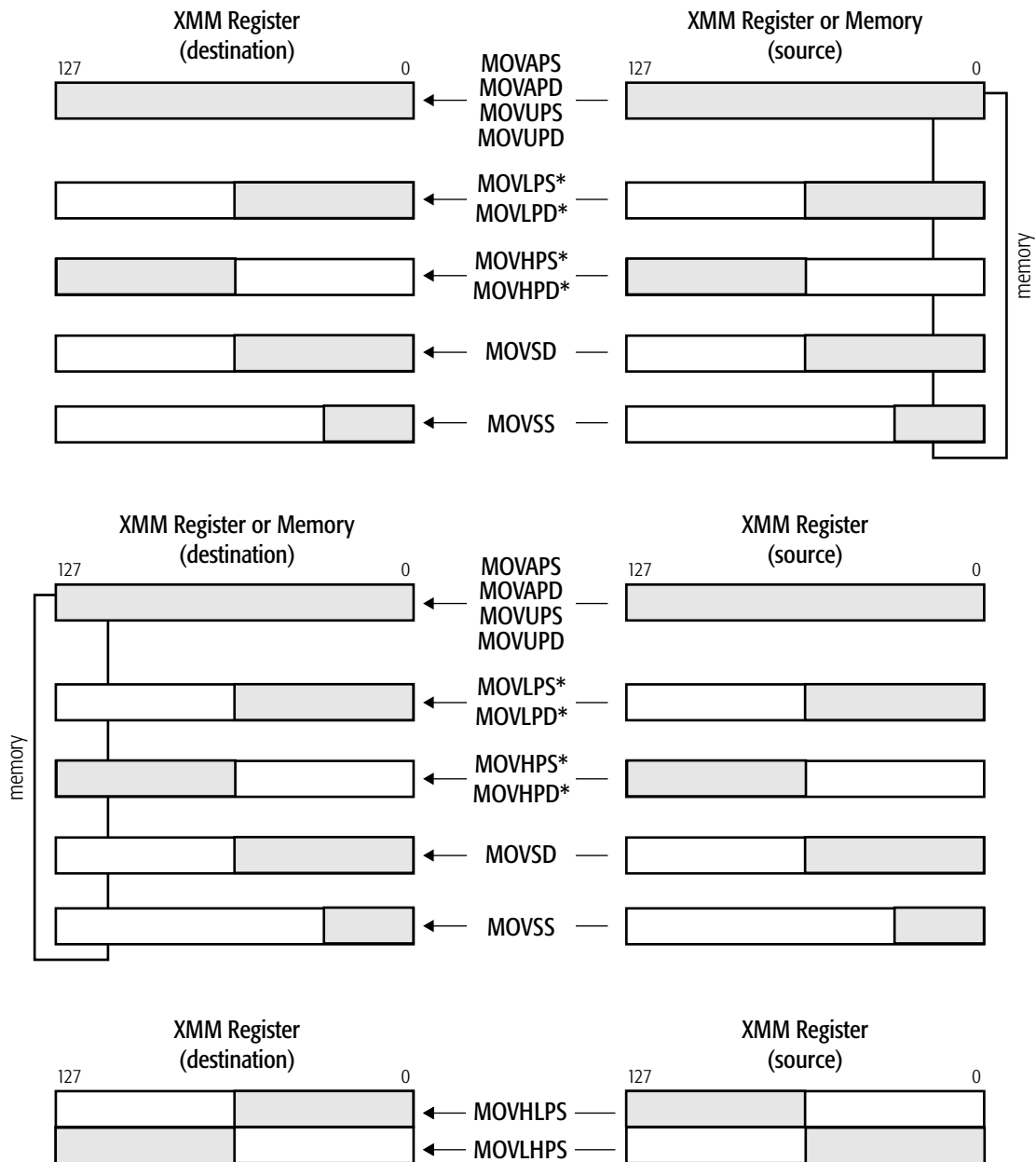

* These instructions copy data only between memory and register or vice versa, not between two registers.

513-169.eps

Figure 4-31. Floating-Point Move Operations

The MOVHPS and MOVHPD instructions copy a vector of two single-precision floating-point values (MOVHPS) or one double-precision floating-point value (MOVHPD) from a 64-bit memory

location to the high-order 64 bits of an XMM register, or from the high-order 64 bits of an XMM register to a 64-bit memory location. In the memory-to-register case, the low-order 64 bits of the destination XMM register are not modified.

The `MOVLPS` and `MOVLPD` instructions copy a vector of two single-precision floating-point values (`MOVLPS`) or one double-precision floating-point value (`MOVLPD`) from a 64-bit memory location to the low-order 64 bits of an XMM register, or from the low-order 64 bits of an XMM register to a 64-bit memory location. In the memory-to-register case, the high-order 64 bits of the destination XMM register are not modified.

The `MOVHLPS` instruction copies a vector of two single-precision floating-point values from the high-order 64 bits of an XMM register to the low-order 64 bits of another XMM register. The high-order 64 bits of the destination XMM register are not modified. The `MOVLHPS` instruction performs an analogous operation except in the opposite direct (low-order to high-order), and the low-order 64 bits of the destination XMM register are not modified.

The `MOVSS` instruction copies a scalar single-precision floating-point value from the low-order 32 bits of an XMM register or a 32-bit memory location to the low-order 32 bits of another XMM register, or vice versa. If the source operand is an XMM register, the high-order 96 bits of the destination XMM register are not modified. If the source operand is a 32-bit memory location, the high-order 96 bits of the destination XMM register are cleared to all 0s.

The `MOVSD` instruction copies a scalar double-precision floating-point value from the low-order 64 bits of an XMM register or a 64-bit memory location to the low-order 64 bits of another XMM register, or vice versa. If the source operand is an XMM register, the high-order 64 bits of the destination XMM register are not modified. If the source operand is a memory location, the high-order 64 bits of the destination XMM register are cleared to all 0s.

The above `MOVSD` instruction should not be confused with the same-mnemonic `MOVSD` (move string doubleword) instruction in the general-purpose instruction set. Assemblers distinguish the two instructions by their operand data types.

Move with Duplication. These instructions move two copies of the affected data segments from the source XMM register or 128-bit memory operand to the target destination register.

The `MOVDDUP` moves one copy of the lower quadword of the the source operand into each quadword half of the destination operand.

The `MOVSLDUP` instruction moves two copies of the first doubleword of the source operand into the first two doubleword segments of the destination operand and moves two copies of the third doubleword of the source operand into the third and fourth doubleword segments of the destination operand.

The `MOVSHDUP` instruction moves two copies of the second doubleword of the source operand into the first two doubleword segments of the destination operand and moves two copies of the fourth doubleword of the source operand into the upper two doubleword segments of the destination operand.

Move Non-Temporal. The move non-temporal instructions are *streaming-store* instructions. They minimize pollution of the cache.

- `MOVNTPS`—Move Non-Temporal Packed Single-Precision Floating-Point
- `MOVNTPD`—Move Non-Temporal Packed Double-Precision Floating-Point

The `MOVNTPx` instructions copy four single-precision floating-point (`MOVNTPS`) or two double-precision floating-point (`MOVNTPD`) values from an XMM register into a 128-bit memory location.

These instructions indicate to the processor that their data is *non-temporal*, which assumes that the data they reference will be used only once and is therefore not subject to cache-related overhead (as opposed to *temporal* data, which assumes that the data will be accessed again soon and should be cached). The non-temporal instructions use weakly-ordered, write-combining buffering of write data, and they minimizes cache pollution. The exact method by which cache pollution is minimized depends on the hardware implementation of the instruction. For further information, see “Memory Optimization” on page 115.

Move Mask.

- MOVMSKPS—Extract Packed Single-Precision Floating-Point Sign Mask
- MOVMSKPD—Extract Packed Double-Precision Floating-Point Sign Mask

The MOVMSKPS instruction copies the sign bits of four single-precision floating-point values in an XMM register to the four low-order bits of a 32-bit or 64-bit general-purpose register, with zero-extension. The MOVMSKPD instruction copies the sign bits of two double-precision floating-point values in an XMM register to the two low-order bits of a general-purpose register, with zero-extension. The result of either instruction is a sign-bit mask that can be used for data-dependent branching. Figure 4-32 on page 197 shows the MOVMSKPS operation.

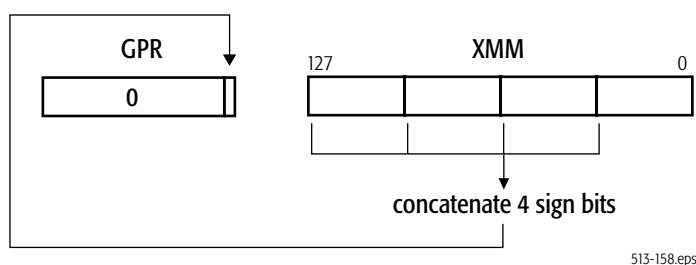

Figure 4-32. MOVMSKPS Move Mask Operation

4.6.3 Data Conversion

The floating-point data-conversion instructions convert floating-point operands to integer operands.

These data-conversion instructions take 128-bit floating-point source operands. For data-conversion instructions that take 128-bit integer source operands, see “Data Conversion” on page 171. For data-conversion instructions that take 64-bit source operands, see “Data Conversion” on page 258 and “Data Conversion” on page 274.

Convert Floating-Point to Floating-Point. These instructions convert floating-point data types in XMM registers or memory into different floating-point data types in XMM registers.

- CVTSS2PD—Convert Packed Single-Precision Floating-Point to Packed Double-Precision Floating-Point

- CVTPD2PS—Convert Packed Double-Precision Floating-Point to Packed Single-Precision Floating-Point
- CVTSS2SD—Convert Scalar Single-Precision Floating-Point to Scalar Double-Precision Floating-Point
- CVTSD2SS—Convert Scalar Double-Precision Floating-Point to Scalar Single-Precision Floating-Point

The CVTPS2PD instruction converts two single-precision floating-point values in the low-order 64 bits of the second operand (an XMM register or a 64-bit memory location) to two double-precision floating-point values in the destination operand (an XMM register).

The CVTPD2PS instruction converts two double-precision floating-point values in the second operand to two single-precision floating-point values in the low-order 64 bits of the destination. The high-order 64 bits in the destination XMM register are cleared to all 0s. If the result of the conversion is an inexact value, the value is rounded.

The CVTSS2SD instruction converts a single-precision floating-point value in the low-order 32 bits of the second operand to a double-precision floating-point value in the low-order 64 bits of the destination. The high-order 64 bits in the destination XMM register are not modified.

The CVTSD2SS instruction converts a double-precision floating-point value in the low-order 64 bits of the second operand to a single-precision floating-point value in the low-order 64 bits of the destination. The three high-order doublewords in the destination XMM register are not modified. If the result of the conversion is an inexact value, the value is rounded.

Convert Floating-Point to XMM Integer. These instructions convert floating-point data types in XMM registers or memory into integer data types in XMM registers.

- CVTPS2DQ—Convert Packed Single-Precision Floating-Point to Packed Doubleword Integers
- CVTPD2DQ—Convert Packed Double-Precision Floating-Point to Packed Doubleword Integers
- CVTTPS2DQ—Convert Packed Single-Precision Floating-Point to Packed Doubleword Integers, Truncated

- CVTTPD2DQ—Convert Packed Double-Precision Floating-Point to Packed Doubleword Integers, Truncated

The CVTTPS2DQ and CVTTPS2DQ instructions convert four single-precision floating-point values in the second operand to four 32-bit signed integer values in the destination. For the CVTTPS2DQ instruction, if the result of the conversion is an inexact value, the value is rounded, but for the CVTTPS2DQ instruction such a result is truncated (rounded toward zero).

The CVTPD2DQ and CVTTPD2DQ instructions convert two double-precision floating-point values in the second operand to two 32-bit signed integer values in the destination. The high-order 64 bits in the destination XMM register are cleared to all 0s. For the CVTPD2DQ instruction, if the result of the conversion is an inexact value, the value is rounded, but for the CVTTPD2DQ instruction such a result is truncated (rounded toward zero).

For a description of 128-bit media instructions that convert in the opposite direction—integer to floating-point—see “Convert Integer to Floating-Point” on page 171.

Convert Floating-Point to MMX™ Integer. These instructions convert floating-point data types in XMM registers or memory into integer data types in MMX registers.

- CVTTPS2PI—Convert Packed Single-Precision Floating-Point to Packed Doubleword Integers
- CVTPD2PI—Convert Packed Double-Precision Floating-Point to Packed Doubleword Integers
- CVTTPS2PI—Convert Packed Single-Precision Floating-Point to Packed Doubleword Integers, Truncated
- CVTTPD2PI—Convert Packed Double-Precision Floating-Point to Packed Doubleword Integers, Truncated

The CVTTPS2PI and CVTTPS2PI instructions convert two single-precision floating-point values in the low-order 64 bits of an XMM register or a 64-bit memory location to two 32-bit signed integer values in an MMX register. For the CVTTPS2PI instruction, if the result of the conversion is an inexact value, the value is rounded, but for the CVTTPS2PI instruction such a result is truncated (rounded toward zero).

The CVTPD2PI and CVTTPD2PI instructions convert two double-precision floating-point values in an XMM register or a

128-bit memory location to two 32-bit signed integer values in an MMX register. For the CVTPD2PI instruction, if the result of the conversion is an inexact value, the value is rounded, but for the CVTTPD2PI instruction such a result is truncated (rounded toward zero).

Before executing a CVTxPS2PI or CVTxPD2PI instruction, software should ensure that the MMX registers are properly initialized so as to prevent conflict with their aliased use by x87 floating-point instructions. This may require clearing the MMX state, as described in “Accessing Operands in MMX™ Registers” on page 231.

For a description of 128-bit media instructions that convert in the opposite direction—integer in MMX registers to floating-point in XMM registers—see “Convert MMX Integer to Floating-Point” on page 171. For a summary of instructions that operate on MMX registers, see Chapter 5, “64-Bit Media Programming.”

Convert Floating-Point to GPR Integer. These instructions convert floating-point data types in XMM registers or memory into integer data types in GPR registers.

- CVTSS2SI—Convert Scalar Single-Precision Floating-Point to Signed Doubleword or Quadword Integer
- CVTSD2SI—Convert Scalar Double-Precision Floating-Point to Signed Doubleword or Quadword Integer
- CVTTSS2SI—Convert Scalar Single-Precision Floating-Point to Signed Doubleword or Quadword Integer, Truncated
- CVTTSD2SI—Convert Scalar Double-Precision Floating-Point to Signed Doubleword or Quadword Integer, Truncated

The CVTSS2SI and CVTTSS2SI instructions convert a single-precision floating-point value in the low-order 32 bits of an XMM register or a 32-bit memory location to a 32-bit or 64-bit signed integer value in a general-purpose register. For the CVTSS2SI instruction, if the result of the conversion is an inexact value, the value is rounded, but for the CVTTSS2SI instruction such a result is truncated (rounded toward zero).

The CVTSD2SI and CVTTSD2SI instructions convert a double-precision floating-point value in the low-order 64 bits of an XMM register or a 64-bit memory location to a 32-bit or 64-bit signed integer value in a general-purpose register. For the

CVTSD2SI instruction, if the result of the conversion is an inexact value, the value is rounded, but for the CVTTSD2SI instruction such a result is truncated (rounded toward zero).

For a description of 128-bit media instructions that convert in the opposite direction—integer in GPR registers to floating-point in XMM registers—see “Convert GPR Integer to Floating-Point” on page 172. For a summary of instructions that operate on GPR registers, see Chapter 3, “General-Purpose Programming.”

4.6.4 Data Reordering

The floating-point data-reordering instructions unpack and interleave, or shuffle the elements of vector operands.

Unpack and Interleave. These instructions interleave vector elements from the high or low halves of two floating-point source operands.

- UNPCKHPS—Unpack High Single-Precision Floating-Point
- UNPCKHPD—Unpack High Double-Precision Floating-Point
- UNPCKLPS—Unpack Low Single-Precision Floating-Point
- UNPCKLPD—Unpack Low Double-Precision Floating-Point

The UNPCKHPx instructions copy the high-order two single-precision floating-point values (UNPCKHPS) or one double-precision floating-point value (UNPCKHPD) in the first and second operands and interleave them into the 128-bit destination. The low-order 64 bits of the source operands are ignored.

The UNPCKLPx instructions are analogous to their high-element counterparts except that they take elements from the low quadword of each source vector and ignore elements in the high quadword.

Depending on the hardware implementation, if the source operand for UNPCKHPx or UNPCKLPx is in memory, only the low 64 bits of the operand may be loaded.

Figure 4-33 shows the UNPCKLPS instruction. The elements are taken from the low half of the source operands. In this register image, elements from *operand2* are placed to the left of elements from *operand1*.

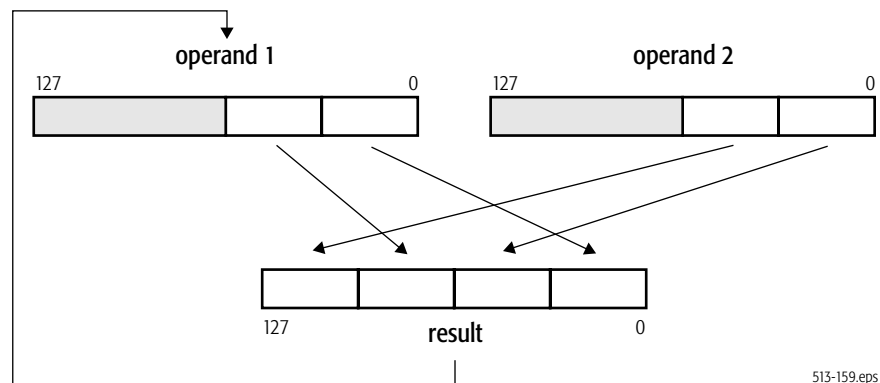

Figure 4-33. UNPCKLPS Unpack and Interleave Operation

Shuffle. These instructions reorder the elements of a vector.

- SHUFPS—Shuffle Packed Single-Precision Floating-Point
- SHUFPD—Shuffle Packed Double-Precision Floating-Point

The SHUFPS instruction moves any two of the four single-precision floating-point values in the first operand to the low-order quadword of the destination and moves any two of the four single-precision floating-point values in the second operand to the high-order quadword of the destination. In each case, the value of the destination is determined by a field in the immediate-byte operand.

Figure 4-34 shows the SHUFPS shuffle operation. SHUFPS is useful, for example, in color imaging when computing alpha saturation of RGB values. In this case, SHUFPS can replicate an alpha value in a register so that parallel comparisons with three RGB values can be performed.

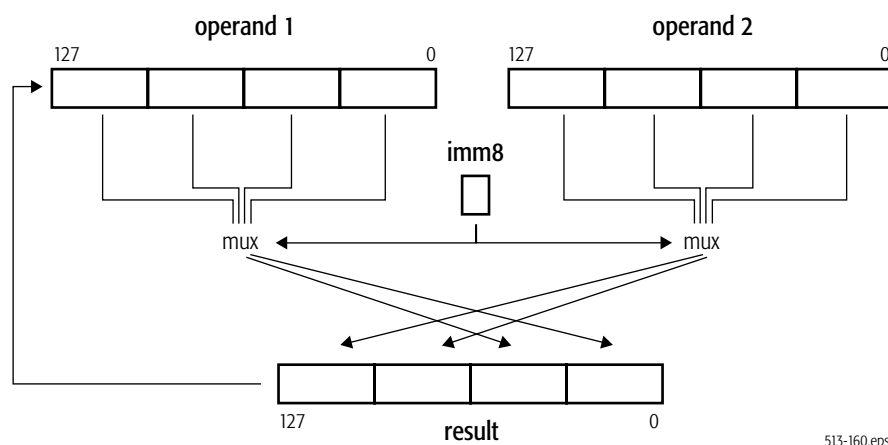

513-160.eps

Figure 4-34. SHUFPS Shuffle Operation

The SHUFPS instruction moves either of the two double-precision floating-point values in the first operand to the low-order quadword of the destination and moves either of the two double-precision floating-point values in the second operand to the high-order quadword of the destination.

4.6.5 Arithmetic

The floating-point vector-arithmetic instructions perform an arithmetic operation on two floating-point operands.

Addition.

- ADDPS—Add Packed Single-Precision Floating-Point
- ADDPD—Add Packed Double-Precision Floating-Point
- ADDSS—Add Scalar Single-Precision Floating-Point
- ADDSD—Add Scalar Double-Precision Floating-Point

The ADDPS instruction adds each of four single-precision floating-point values in the first operand to the corresponding single-precision floating-point values in the second operand and writes the result in the corresponding quadword of the destination. The ADDPD instruction performs an analogous operation for two double-precision floating-point values.

Figure 4-35 shows a typical arithmetic operation on vectors of floating-point single-precision elements—in this case an ADDPS instruction. The instruction performs four arithmetic operations in parallel.

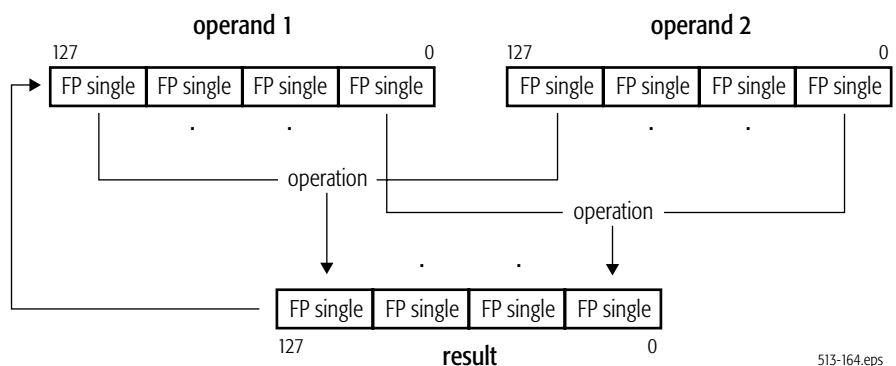

Figure 4-35. ADDPS Arithmetic Operation

The ADDSS instruction adds the single-precision floating-point value in the low-order doubleword of the first operand to the single-precision floating-point value in the low-order doubleword of the second operand and writes the result in the low-order doubleword of the destination. The three high-order doublewords of the destination are not modified.

The ADDSD instruction adds the double-precision floating-point value in the low-order quadword of the first operand to the double-precision floating-point value in the low-order quadword of the second operand and writes the result in the low-order quadword of the destination. The high-order quadword of the destination is not modified.

Horizontal Addition.

- HADDPS—Horizontal Add Packed Single-Precision Floating-Point
- HADDPD—Horizontal Subtract Packed Double-Precision Floating-Point

The HADDPS instruction adds the single-precision floating point values in the first and second doublewords of the destination operand and stores the sum in the first doubleword of the destination operand. It adds the single-precision floating point values in the third and fourth doublewords of the destination operand and stores the sum in the second doubleword of the destination operand. It adds the single-precision floating point values in the first and second

doublewords of the source operand and stores the sum in the third doubleword of the destination operand. It adds single-precision floating point values in the third and fourth doublewords of the source operand and stores the sum in the fourth doubleword of the destination operand.

The HADDPD instruction adds the two double-precision floating point values in the quadword halves of the destination operand and stores the sum in the first quadword of the destination. It adds the values in the two quadword halves of the source register and stores the sum in the second quadword of the destination register.

Subtraction.

- SUBPS—Subtract Packed Single-Precision Floating-Point
- SUBPD—Subtract Packed Double-Precision Floating-Point
- SUBSS—Subtract Scalar Single-Precision Floating-Point
- SUBSD—Subtract Scalar Double-Precision Floating-Point

The SUBPS instruction subtracts each of four single-precision floating-point values in the second operand from the corresponding single-precision floating-point value in the first operand and writes the result in the corresponding quadword of the destination. The SUBPD instruction performs an analogous operation for two double-precision floating-point values.

For vectors of n number of elements, the operations are:

$$\text{operand1}[i] = \text{operand1}[i] - \text{operand2}[i]$$

where: $i = 0$ to $n - 1$

The SUBSS instruction subtracts the single-precision floating-point value in the low-order doubleword of the second operand from the corresponding single-precision floating-point value in the low-order doubleword of the first operand and writes the result in the low-order doubleword of the destination. The three high-order doublewords of the destination are not modified.

The SUBSD instruction subtracts the double-precision floating-point value in the low-order quadword of the second operand from the corresponding double-precision floating-point value in the low-order quadword of the first operand and writes the result in the low-order quadword of the destination. The high-order quadword of the destination is not modified.

Horizontal Subtraction.

- HSUBPS—Horizontal Subtract Packed Single-Precision Floating-Point
- HSUBPD—Horizontal Subtract Packed Double-Precision Floating-Point

The HSUBPS instruction subtracts the packed-singled precision operand in the second doubleword of the destination register from that in the first doubleword of the destination register and stores the result in the first doubleword of the destination register. It subtracts the fourth doubleword of the destination operand from the third doubleword of the destination operand and stores the result in the second doubleword of the destination. It subtracts the packed-singled precision operand in the second doubleword of the source register from that in the first doubleword of the source register and stores the result in the third doubleword of the destination register. It subtracts the fourth doubleword of the source operand from the third doubleword of the source operand and stores the result in the fourth doubleword of the destination.

The HSUBPD instruction subtracts the second quadword of the destination register from the first quadword of the destination operand and stores the difference in the first quadword of the destination register. The difference from the subtraction of the first quadword of the source operand from the second quadword of the source operand is stored in the second quadword of the destination operand.

Simultaneous Addition and Subtraction.

- ADDSUBPS—Add/Subtract Packed Single-Precision Floating-Point
- ADDSUBPD—Add/Subtract Packed Double-Precision Floating-Point

The ADDSUBPS instruction adds the second and fourth doublewords of the source operand to the second and fourth doublewords, respectively, of the destination operand and stores the resulting sums in the second and fourth doublewords of the destination operand; subtracts the first and third doublewords of the first operand from the first and third doublewords of the destination operand and stores the resulting differences in the first and third doublewords of the destination operand.

The ADDSUBPD instruction subtracts the first quadword of the source operand from the first quadword of the destination operand and stores the difference in the first quadword of the destination operand; adds the second quadword of the source operand to the second quadword of the destination operand and stores the sum in the second quadword of the destination operand.

Multiplication.

- MULPS—Multiply Packed Single-Precision Floating-Point
- MULPD—Multiply Packed Double-Precision Floating-Point
- MULSS—Multiply Scalar Single-Precision Floating-Point
- MULSD—Multiply Scalar Double-Precision Floating-Point

The MULPS instruction multiplies each of four single-precision floating-point values in the first operand by the corresponding single-precision floating-point value in the second operand and writes the result in the corresponding doubleword of the destination. The MULPD instruction performs an analogous operation for two double-precision floating-point values.

The MULSS instruction multiplies the single-precision floating-point value in the low-order doubleword of the first operand by the single-precision floating-point value in the low-order doubleword of the second operand and writes the result in the low-order doubleword of the destination. The three high-order doublewords of the destination are not modified.

The MULSD instruction multiplies the double-precision floating-point value in the low-order quadword of the first operand by the double-precision floating-point value in the low-order quadword of the second operand and writes the result in the low-order quadword of the destination. The high-order quadword of the destination is not modified.

Division.

- DIVPS—Divide Packed Single-Precision Floating-Point
- DIVPD—Divide Packed Double-Precision Floating-Point
- DIVSS—Divide Scalar Single-Precision Floating-Point
- DIVSD—Divide Scalar Double-Precision Floating-Point

The DIVPS instruction divides each of the four single-precision floating-point values in the first operand by the corresponding

single-precision floating-point value in the second operand and writes the result in the corresponding quadword of the destination. The DIVPD instruction performs an analogous operation for two double-precision floating-point values. For vectors of n number of elements, the operations are:

$$\text{operand1}[i] = \text{operand1}[i] \div \text{operand2}[i]$$

where: $i = 0$ to $n - 1$

The DIVSS instruction divides the single-precision floating-point value in the low-order doubleword of the first operand by the single-precision floating-point value in the low-order doubleword of the second operand and writes the result in the low-order doubleword of the destination. The three high-order doublewords of the destination are not modified.

The DIVSD instruction divides the double-precision floating-point value in the low-order quadword of the first operand by the double-precision floating-point value in the low-order quadword of the second operand and writes the result in the low-order quadword of the destination. The high-order quadword of the destination is not modified.

If accuracy requirements allow, convert floating-point division by a constant to a multiply by the reciprocal. Divisors that are powers of two and their reciprocals are exactly representable, and therefore do not cause an accuracy issue, except for the rare cases in which the reciprocal overflows or underflows.

Square Root.

- SQRTPS—Square Root Packed Single-Precision Floating-Point
- SQRTPD—Square Root Packed Double-Precision Floating-Point
- SqrtSS—Square Root Scalar Single-Precision Floating-Point
- SQRTSD—Square Root Scalar Double-Precision Floating-Point

The SQRTPS instruction computes the square root of each of four single-precision floating-point values in the second operand (an XMM register or 128-bit memory location) and writes the result in the corresponding doubleword of the

destination. The SQRTPD instruction performs an analogous operation for two double-precision floating-point values.

The SQRSS instruction computes the square root of the low-order single-precision floating-point value in the second operand (an XMM register or 32-bit memory location) and writes the result in the low-order doubleword of the destination. The three high-order doublewords of the destination XMM register are not modified.

The SQRTSD instruction computes the square root of the low-order double-precision floating-point value in the second operand (an XMM register or 64-bit memory location) and writes the result in the low-order quadword of the destination. The high-order quadword of the destination XMM register is not modified.

Reciprocal Square Root.

- RSQRTPS—Reciprocal Square Root Packed Single-Precision Floating-Point
- RSQRTSS—Reciprocal Square Root Scalar Single-Precision Floating-Point

The RSQRTPS instruction computes the approximate reciprocal of the square root of each of four single-precision floating-point values in the second operand (an XMM register or 128-bit memory location) and writes the result in the corresponding doubleword of the destination.

The RSQRTSS instruction computes the approximate reciprocal of the square root of the low-order single-precision floating-point value in the second operand (an XMM register or 32-bit memory location) and writes the result in the low-order doubleword of the destination. The three high-order doublewords in the destination XMM register are not modified.

For both RSQRTPS and RSQRTSS, the maximum relative error is less than or equal to $1.5 * 2^{-12}$.

Reciprocal Estimation.

- RCPPS—Reciprocal Packed Single-Precision Floating-Point
- RCPSS—Reciprocal Scalar Single-Precision Floating-Point

The RCPPS instruction computes the approximate reciprocal of each of the four single-precision floating-point values in the second operand (an XMM register or 128-bit memory location) and writes the result in the corresponding doubleword of the destination.

The RCPSS instruction computes the approximate reciprocal of the low-order single-precision floating-point value in the second operand (an XMM register or 32-bit memory location) and writes the result in the low-order doubleword of the destination. The three high-order doublewords in the destination are not modified.

For both RCPPS and RCPSS, the maximum relative error is less than or equal to $1.5 * 2^{-12}$.

4.6.6 Compare

The floating-point vector-compare instructions compare two operands, and they either write a mask, or they write the maximum or minimum value, or they set flags. Compare

instructions can be used to avoid branches. Figure 4-10 on page 142 shows an example of using compare instructions.

Compare and Write Mask.

- CMPPS—Compare Packed Single-Precision Floating-Point
- CMPPD—Compare Packed Double-Precision Floating-Point
- CMPSS—Compare Scalar Single-Precision Floating-Point
- CMPSD—Compare Scalar Double-Precision Floating-Point

The CMPPS instruction compares each of four single-precision floating-point values in the first operand with the corresponding single-precision floating-point value in the second operand and writes the result in the corresponding 32 bits of the destination. The type of comparison is specified by the three low-order bits of the immediate-byte operand. The result of each compare is a 32-bit value of all 1s (TRUE) or all 0s (FALSE). Some compare operations that are not directly supported by the immediate-byte encodings can be implemented by swapping the contents of the source and destination operands before executing the compare.

The CMPPD instruction performs an analogous operation for two double-precision floating-point values. The CMPSS instruction performs an analogous operation for the single-precision floating-point values in the low-order 32 bits of the source operands. The three high-order doublewords of the destination are not modified. The CMPSD instruction performs an analogous operation for the double-precision floating-point values in the low-order 64 bits of the source operands. The high-order 64 bits of the destination XMM register are not modified.

Figure 4-36 on page 212 shows a CMPPD compare operation.

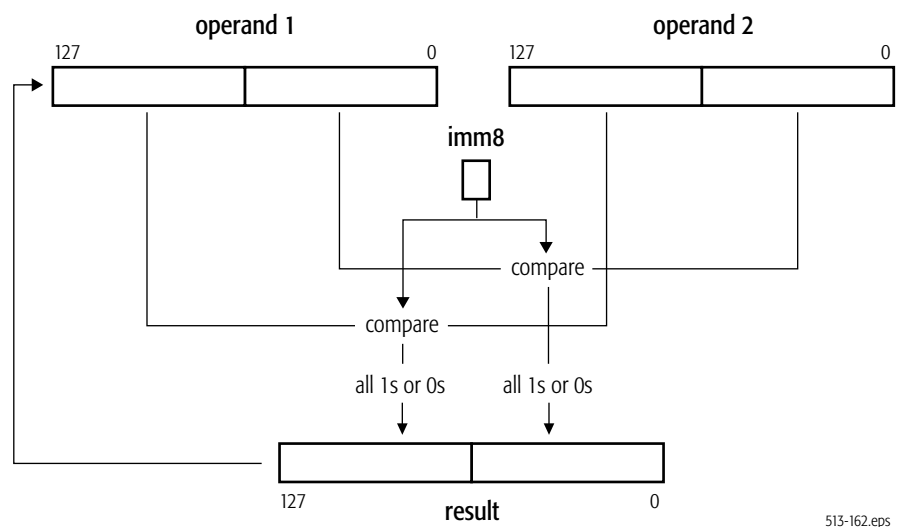

513-162.eps

Figure 4-36. CMPPD Compare Operation

Compare and Write Minimum or Maximum.

- MAXPS—Maximum Packed Single-Precision Floating-Point
- MAXPD—Maximum Packed Double-Precision Floating-Point
- MAXSS—Maximum Scalar Single-Precision Floating-Point
- MAXSD—Maximum Scalar Double-Precision Floating-Point
- MINPS—Minimum Packed Single-Precision Floating-Point
- MINPD—Minimum Packed Double-Precision Floating-Point
- MINSS—Minimum Scalar Single-Precision Floating-Point
- MINS—Minimum Scalar Double-Precision Floating-Point

The MAXPS and MINPS instructions compare each of four single-precision floating-point values in the first operand with the corresponding single-precision floating-point value in the second operand and writes the maximum or minimum, respectively, of the two values in the corresponding doubleword of the destination. The MAXPD and MINPD instructions perform analogous operations on pairs of double-precision floating-point values.

The MAXSS and MINSS instructions compare the single-precision floating-point value in the low-order 32 bits of the

first operand with the single-precision floating-point value in the low-order 32 bits of the second operand and writes the maximum or minimum, respectively, of the two values in the low-order 32 bits of the destination. The three high-order doublewords of the destination XMM register are not modified.

The MAXSD and MINSD instructions compare the double-precision floating-point value in the low-order 64 bits of the first operand with the double-precision floating-point value in the low-order 64 bits of the second operand and writes the maximum or minimum, respectively, of the two values in the low-order quadword of the destination. The high-order quadword of the destination XMM register is not modified.

The MIN x and MAX x instructions are useful for clamping (saturating) values, such as color values in 3D geometry and rasterization.

Compare and Write rFLAGS.

- COMISS—Compare Ordered Scalar Single-Precision Floating-Point
- COMISD—Compare Ordered Scalar Double-Precision Floating-Point
- UCOMISS—Unordered Compare Scalar Single-Precision Floating-Point
- UCOMISD—Unordered Compare Scalar Double-Precision Floating-Point

The COMISS instruction performs an ordered compare of the single-precision floating-point value in the low-order 32 bits of the first operand with the single-precision floating-point value in the low-order 32 bits of the second operand and sets the zero flag (ZF), parity flag (PF), and carry flag (CF) bits in the rFLAGS register to reflect the result of the compare. The OF, AF, and SF bits in rFLAGS are set to zero.

The COMISD instruction performs an analogous operation on the double-precision floating-point values in the low-order 64 bits of the source operands. The UCOMISS and UCOMISD instructions perform an analogous, but unordered, compare operations. Figure 4-37 on page 214 shows a COMISD compare operation.

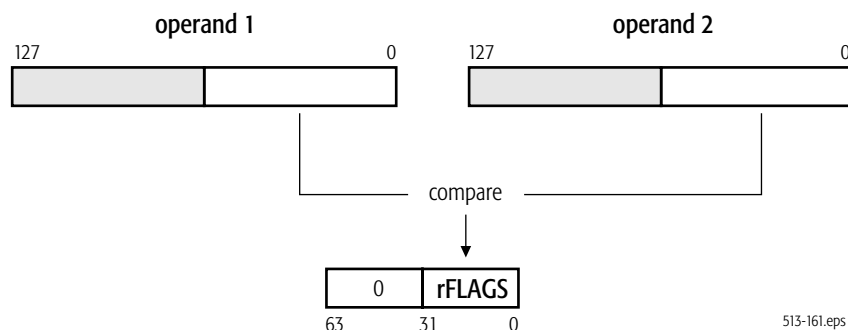

Figure 4-37. COMISD Compare Operation

The difference between an ordered and unordered comparison has to do with the conditions under which a floating-point invalid-operation exception (IE) occurs. In an ordered comparison (COMISS or COMISD), an IE exception occurs if either of the source operands is either type of NaN (QNaN or SNaN). In an unordered comparison, the exception occurs only if a source operand is an SNaN. For a description of NaNs, see “Floating-Point Number Representation” on page 157. For a description of exceptions, see “Exceptions” on page 217.

4.6.7 Logical

The vector-logic instructions perform Boolean logic operations, including AND, OR, and exclusive OR.

And.

- ANDPS—Logical Bitwise AND Packed Single-Precision Floating-Point
- ANDPD—Logical Bitwise AND Packed Double-Precision Floating-Point
- ANDNPS—Logical Bitwise AND NOT Packed Single-Precision Floating-Point
- ANDNPD—Logical Bitwise AND NOT Packed Double-Precision Floating-Point

The ANDPS instruction performs a logical bitwise AND of the four packed single-precision floating-point values in the first operand and the corresponding four single-precision floating-point values in the second operand and writes the result in the destination. The ANDPD instruction performs an analogous

operation on two packed double-precision floating-point values. The ANDNPS and ANDNPD instructions invert the elements of the first source vector (creating a one's complement of each element), AND them with the elements of the second source vector, and write the result to the destination.

Or.

- ORPS—Logical Bitwise OR Packed Single-Precision Floating-Point
- ORPD—Logical Bitwise OR Packed Double-Precision Floating-Point

The ORPS instruction performs a logical bitwise OR of four single-precision floating-point values in the first operand and the corresponding four single-precision floating-point values in the second operand and writes the result in the destination. The ORPD instruction performs an analogous operation on pairs of two double-precision floating-point values.

Exclusive Or.

- XORPS—Logical Bitwise Exclusive OR Packed Single-Precision Floating-Point
- XORPD—Logical Bitwise Exclusive OR Packed Double-Precision Floating-Point

The XORPS instruction performs a logical bitwise exclusive OR of four single-precision floating-point values in the first operand and the corresponding four single-precision floating-point values in the second operand and writes the result in the destination. The XORPD instruction performs an analogous operation on pairs of two double-precision floating-point values.

4.7 Instruction Effects on Flags

The STMXCSR and LDMXCSR instructions, described in “Save and Restore State” on page 191, read and write flags in the MXCSR register. For a description of the MXCSR register, see “MXCSR Register” on page 144.

The COMISS, COMISD, UCOMISS, and UCOMISD instructions, described in “Compare” on page 210, write flag bits in the rFLAGS register. For a description of the rFLAGS register, see “Flags Register” on page 38.

4.8 Instruction Prefixes

Instruction prefixes, in general, are described in “Instruction Prefixes” on page 87. The following restrictions apply to the use of instruction prefixes with 128-bit media instructions.

4.8.1 Supported Prefixes

The following prefixes can be used with 128-bit media instructions:

- *Address-Size Override*—The 67h prefix affects only operands in memory. The prefix is ignored by all other 128-bit media instructions.
- *Operand-Size Override*—The 66h prefix is used to form the opcodes of certain 128-bit media instructions. The prefix is ignored by all other 128-bit media instructions.
- *Segment Overrides*—The 2Eh (CS), 36h (SS), 3Eh (DS), 26h (ES), 64h (FS), and 65h (GS) prefixes affect only operands in memory. In 64-bit mode, the contents of the CS, DS, ES, SS segment registers are ignored.
- *REP*—The F2 and F3h prefixes do not function as repeat prefixes for 128-bit media instructions. Instead, they are used to form the opcodes of certain 128-bit media instructions. The prefixes are ignored by all other 128-bit media instructions.
- *REX*—The REX prefixes affect operands that reference a GPR or XMM register when running in 64-bit mode. It allows access to the full 64-bit width of any of the 16 extended GPRs and to any of the 16 extended XMM registers. The REX prefix also affects the FXSAVE and FXRSTOR instructions, in which it selects between two types of 512-byte memory-image format, as described in “Saving Media and x87 Processor State” in Volume 2. The prefix is ignored by all other 128-bit media instructions.

4.8.2 Special-Use and Reserved Prefixes

The following prefixes are used as opcode bytes in some 128-bit media instructions and are reserved in all other 128-bit media instructions:

- *Operand-Size Override*—The 66h prefix.
- *REP*—The F2 and F3h prefixes.

4.8.3 Prefixes That Cause Exceptions

The following prefixes cause an exception:

- *LOCK*—The F0h prefix causes an invalid-opcode exception when used with 128-bit media instructions.

4.9 Feature Detection

Before executing 128-bit media instructions, software should determine whether the processor supports the technology by executing the CPUID instruction. “Feature Detection” on page 92 describes how software uses the CPUID instruction to detect feature support. For full support of the 128-bit media instructions documented here, the following features require detection:

- SSE, indicated by EDX bit 25 returned by CPUID standard function 1.
- SSE2, indicated by EDX bit 26 returned by CPUID standard function 1.
- SSE3, indicated by ECX bit 0 returned by CPUID standard function 1.
- FXSAVE and FXRSTOR, indicated by EDX bit 24 returned by CPUID standard function 1 and extended function 8000_0001h.

Software that runs in long mode should also check for the following support:

- Long Mode, indicated by bit 29 of CPUID extended function 8000_0001h.

See “Processor Feature Identification” in Volume 2 for a full description of the CPUID instruction and its function codes.

In addition, the operating system must support the FXSAVE and FXRSTOR instructions (by having set CR4.OSFXSR = 1), and it may wish to support SIMD floating-point exceptions (by having set CR4.OSXMMEXCPT = 1). For details, see “System-Control Registers” in Volume 2.

4.10 Exceptions

Types of Exceptions. 128-bit media instructions can generate two types of exceptions:

- *General-Purpose Exceptions*, described below in “General-Purpose Exceptions”
- *SIMD Floating-Point Exception*, described below in “SIMD Floating-Point Exception Causes” on page 219

Relation to x87 Exceptions. Although the 128-bit media instructions and the x87 floating-point instructions each have certain exceptions with the same names, the exception-reporting and exception-handling methods used by the two instruction subsets are distinct and independent of each other. If procedures using both types of instructions are run in the same operating environment, separate services routines should be provided for the exceptions of each type of instruction subset.

4.10.1 General-Purpose Exceptions

The sections below list general-purpose exceptions generated and not generated by 128-bit media instructions. For a summary of the general-purpose exception mechanism, see “Interrupts and Exceptions” on page 106. For details about each exception and its potential causes, see “Exceptions and Interrupts” in Volume 2.

Exceptions Generated. The 128-bit media instructions can generate the following general-purpose exceptions:

- #DB—Debug Exception (Vector 1)
- #UD—Invalid-Opcode Exception (Vector 6)
- #NM—Device-Not-Available Exception (Vector 7)
- #DF—Double-Fault Exception (Vector 8)
- #SS—Stack Exception (Vector 12)
- #GP—General-Protection Exception (Vector 13)
- #PF—Page-Fault Exception (Vector 14)
- #MF—x87 Floating-Point Exception-Pending (Vector 16)
- #AC—Alignment-Check Exception (Vector 17)
- #MC—Machine-Check Exception (Vector 18)
- #XF—SIMD Floating-Point Exception (Vector 19)

A device-not-available exception (#NM) can occur if an attempt is made to execute a 128-bit media instruction when the task switch bit (TS) of the control register (CR0) is set to 1 (CR0.TS = 1).

An invalid-opcode exception (#UD) can occur if:

- a required CPUID feature flag is not set (see “Feature Detection” on page 217), or
- an FXSAVE or FXRSTOR instruction is executed when the floating-point software-emulation (EM) bit in control register 0 is set to 1 (CR0.EM = 1), or when the operating-

system FXSAVE/FXRSTOR support bit (OSFXSR) in control register 4 is cleared to 0 (CR4.OSXSR = 0), or

- a SIMD floating-point exception occurs when the operating-system XMM exception support bit (OSXMMEXCPT) in control register 4 is cleared to 0 (CR4.OSXMMEXCPT = 0).

Only the following 128-bit media instructions, all of which can access an MMX register, can cause an #MF exception:

- Data Conversion: CVTPD2PI, CVTPS2PI, CPTPI2PD, CVTPI2PS, CVTTPD2PI, CVTTPS2PI.
- Data Transfer: MOVDQ2Q, MOVQ2DQ.

For details on the system control-register bits, see “System-Control Registers” in Volume 2. For details on the machine-check mechanism, see “Machine Check Mechanism” in Volume 2.

For details on #XF exceptions, see “SIMD Floating-Point Exception Causes” on page 219.

Exceptions Not Generated. The 128-bit media instructions do not generate the following general-purpose exceptions:

- #DE—Divide-by-zero-error exception (Vector 0)
- Non-Maskable-Interrupt Exception (Vector 2)
- #BP—Breakpoint Exception (Vector 3)
- #OF—Overflow exception (Vector 4)
- #BR—Bound-range exception (Vector 5)
- Coprocessor-segment-overflow exception (Vector 9)
- #TS—Invalid-TSS exception (Vector 10)
- #NP—Segment-not-present exception (Vector 11)
- #MC—Machine-check exception (Vector 18)

For details on all general-purpose exceptions, see “Exceptions and Interrupts” in Volume 2.

4.10.2 SIMD Floating-Point Exception Causes

The SIMD floating-point exception is the logical OR of the six floating-point exceptions (IE, DE, ZE, OE, UE, PE) that are reported (signalled) in the MXCSR register’s exception flags (“MXCSR Register” on page 144). Each of these six exceptions can be either masked or unmasked by software, using the mask bits in the MXCSR register.

Exception Vectors. The SIMD floating-point exception is listed above as #XF (Vector 19) but it actually causes either an #XF exception or a #UD (Vector 6) exception, if an unmasked IE, DE, ZE, OE, UE, or PE exception is reported. The choice of exception vector is determined by the operating-system XMM exception support bit (OSXMMEXCPT) in control register 4 (CR4):

- When CR4.OSXMMEXCPT = 1, a #XF exception occurs.
- When CR4.OSXMMEXCPT = 0, a #UD exception occurs.

SIMD floating-point exceptions are precise. If an exception occurs when it is masked, the processor responds in a default way that does not invoke the SIMD floating-point exception service routine. If an exception occurs when it is unmasked, the processor suspends processing of the faulting instruction precisely and invokes the exception service routine.

Exception Types and Flags. SIMD floating-point exceptions are differentiated into six types, five of which are mandated by the IEEE 754 standard. These six types and their bit-flags in the MXCSR register are shown in Table 4-11. The causes and handling of such exceptions are described below.

Table 4-11. SIMD Floating-Point Exception Flags

Exception and Mnemonic	MXCSR Bit ¹	Comparable IEEE 754 Exception
Invalid-operation exception (IE)	0	Invalid Operation
Denormalized operation exception (DE)	1	<i>none</i>
Zero-divide exception (ZE)	2	Division by Zero
Overflow exception (OE)	3	Overflow
Underflow exception (UE)	4	Underflow
Precision exception (PE)	5	Inexact

Note:

1. See "MXCSR Register" on page 144 for a summary of each exception.

The sections below describe the causes for the SIMD floating-point exceptions. The pseudocode equations in these descriptions assume logical TRUE = 1 and the following definitions:

Max_{normal}

The largest normalized number that can be represented in the destination format. This is equal to the format's largest representable finite, positive or negative value. (Normal numbers are described in “Normalized Numbers” on page 157.)

Min_{normal}

The smallest normalized number that can be represented in the destination format. This is equal to the format's smallest precisely representable positive or negative value with an unbiased exponent of 1.

Result_{infinite}

A result of infinite precision, which is representable when the width of the exponent and the width of the significand are both infinite.

Result_{round}

A result, after rounding, whose unbiased exponent is infinitely wide and whose significand is the width specified for the destination format. (Rounding is described in “Floating-Point Rounding” on page 162.)

Result_{round, denormal}

A result, after rounding and denormalization. (Denormalization is described in “Denormalized (Tiny) Numbers” on page 158.)

Masked and unmasked responses to the exceptions are described in “SIMD Floating-Point Exception Masking” on page 226. The priority of the exceptions is described in “SIMD Floating-Point Exception Priority” on page 224.

Invalid-Operation Exception (IE). The IE exception occurs due to one of the attempted invalid operations shown in Table 4-12 on page 222.

Table 4-12. Invalid-Operation Exception (IE) Causes

Operation	Condition
Any Arithmetic Operation, and CVTPS2PD, CVTPD2PS, CVTSS2SD, CVTSD2SS	A source operand is an SNaN
MAXPS, MAXPD, MAXSS, MAXSD MINPS, MINPD, MINSS, MINS CMPPS, CMPPD, CMPSS, CMPSD COMISS, COMISD	A source operand is a NaN (QNaN or SNaN)
ADDPS, ADDPD, ADDSS, ADDSD, ADDSUBPS, ADDSUBPD, HADDPS, HADDPD	Source operands are infinities with opposite signs
SUBPS, SUBPD, SUBSS, SUBSD, ADDSUBPS, ADDSUBPD, HSUBPS, HSUBPD	Source operands are infinities with same sign
MULPS, MULPD, MULSS, MULSD	Source operands are zero and infinity
DIVPS, DIVPD, DIVSS, DIVSD	Source operands are both infinity or both zero
SQRTPS, SQRTPD, SQRTSS, SQRTSD	Source operand is less than zero (except ± 0 which returns ± 0)
Data conversion from floating-point to integer (CVTPS2PI, CVTPD2PI, CVTSS2SI, CVTSD2SI, CVTPS2DQ, CVTPD2DQ, CVTTPS2PI, CVTTPD2PI, CVTTPD2DQ, CVTTPS2DQ, CVTSS2SI, CVTSD2SI)	Source operand is a NaN, infinite, or not representable in destination data type

Denormalized-Operand Exception (DE). The DE exception occurs when one of the source operands of an instruction is in denormalized form, as described in “Denormalized (Tiny) Numbers” on page 158.

Zero-Divide Exception (ZE). The ZE exception occurs when and instruction attempts to divide zero into a non-zero finite dividend.

Overflow Exception (OE). The OE exception occurs when the value of a rounded floating-point result is larger than the largest representable normalized positive or negative floating-point number in the destination format. Specifically:

$$OE = \text{Result}_{\text{round}} > \text{Max}_{\text{normal}}$$

An overflow can occur through computation or through conversion of higher-precision numbers to lower-precision numbers.

Underflow Exception (UE). The UE exception occurs when the value of a rounded, non-zero floating-point result is too small to be represented as a normalized positive or negative floating-point number in the destination format. Such a result is called a *tiny* number, associated with the “Precision Exception (PE)” described immediately below.

If UE exceptions are masked by the underflow mask (UM) bit, a UE exception occurs only if the denormalized form of the rounded result is imprecise. Specifically:

$$UE = ((UM=0 \text{ and } (Result_{\text{round}} < Min_{\text{normal}})) \text{ or } ((UM=1 \text{ and } (Result_{\text{round, denormal}}) \neq Result_{\text{infinite}}))$$

Underflows can occur, for example, by taking the reciprocal of the largest representable number, or by converting small numbers in double-precision format to a single-precision format, or simply through repeated division. The flush-to-zero (FZ) bit in the MXCSR offers additional control of underflows that are masked. See “MXCSR Register” on page 144 for details.

Precision Exception (PE). The PE exception, also called the *inexact-result* exception, occurs when a rounded floating-point result differs from the infinitely precise result and thus cannot be represented precisely in the destination format. This exception is caused by—among other things—rounding of underflow or overflow results according to the rounding control (RC) field in the MXCSR, as described in “Floating-Point Rounding” on page 162.

If an overflow or underflow occurs and the OE or UE exceptions are masked by the overflow mask (OM) or underflow mask (UM) bit, a PE exception occurs only if the rounded result (for OE) or the denormalized form of the rounded result (for UE) is imprecise. Specifically:

$$PE = ((Result_{\text{round, denormal}} \text{ or } Result_{\text{round}}) \neq Result_{\text{infinite}}) \text{ or } (OM=1 \text{ and } (Result_{\text{round}} > Max_{\text{normal}})) \text{ or } (UM=1 \text{ and } (Result_{\text{round, denormal}} < Min_{\text{normal}}))$$

Software that does not require exact results normally masks this exception.

4.10.3 SIMD Floating-Point Exception Priority

Table 4-13 shows the priority with which the processor recognizes multiple, simultaneous SIMD floating-point exceptions and operations involving QNaN operands. Each exception type is characterized by its timing, as follows:

- *Pre-Computation*—an exception that is recognized before an instruction begins its operation.
- *Post-Computation*—an exception that is recognized after an instruction completes its operation.

For masked (but not unmasked) post-computation exceptions, a result may be written to the destination, depending on the type of exception. Operations involving QNaNs do not necessarily cause exceptions, but the processor handles them with the priority shown in Table 4-13 relative to the handling of exceptions.

Table 4-13. Priority of SIMD Floating-Point Exceptions

Priority	Exception or Operation	Timing
1	Invalid-operation exception (IE) when accessing SNaN operand	Pre-Computation
2	Operation involving a QNaN operand ¹	–
3	Any other type of invalid-operation exception (IE)	Pre-Computation
	Zero-divide exception (ZE)	Pre-Computation
4	Denormalized operation exception (DE)	Pre-Computation
5	Overflow exception (OE)	Post-Computation
	Underflow exception (UE)	Post-Computation
6	Precision (inexact) exception (PE)	Post-Computation
Note:		
1. Operations involving QNaN operands do not, in themselves, cause exceptions but they are handled with this priority relative to the handling of exceptions.		

Figure 4-38 on page 225 shows the prioritized procedure used by the processor to detect and report SIMD floating-point exceptions. Each of the two types of exceptions—pre-computation and post-computation—is handled independently and completely in the sequence shown. If there are no unmasked exceptions, the processor responds to masked exceptions. Because of this two-step process, up to two

exceptions—one pre-computation, one post-computation—can be caused by a single instruction.

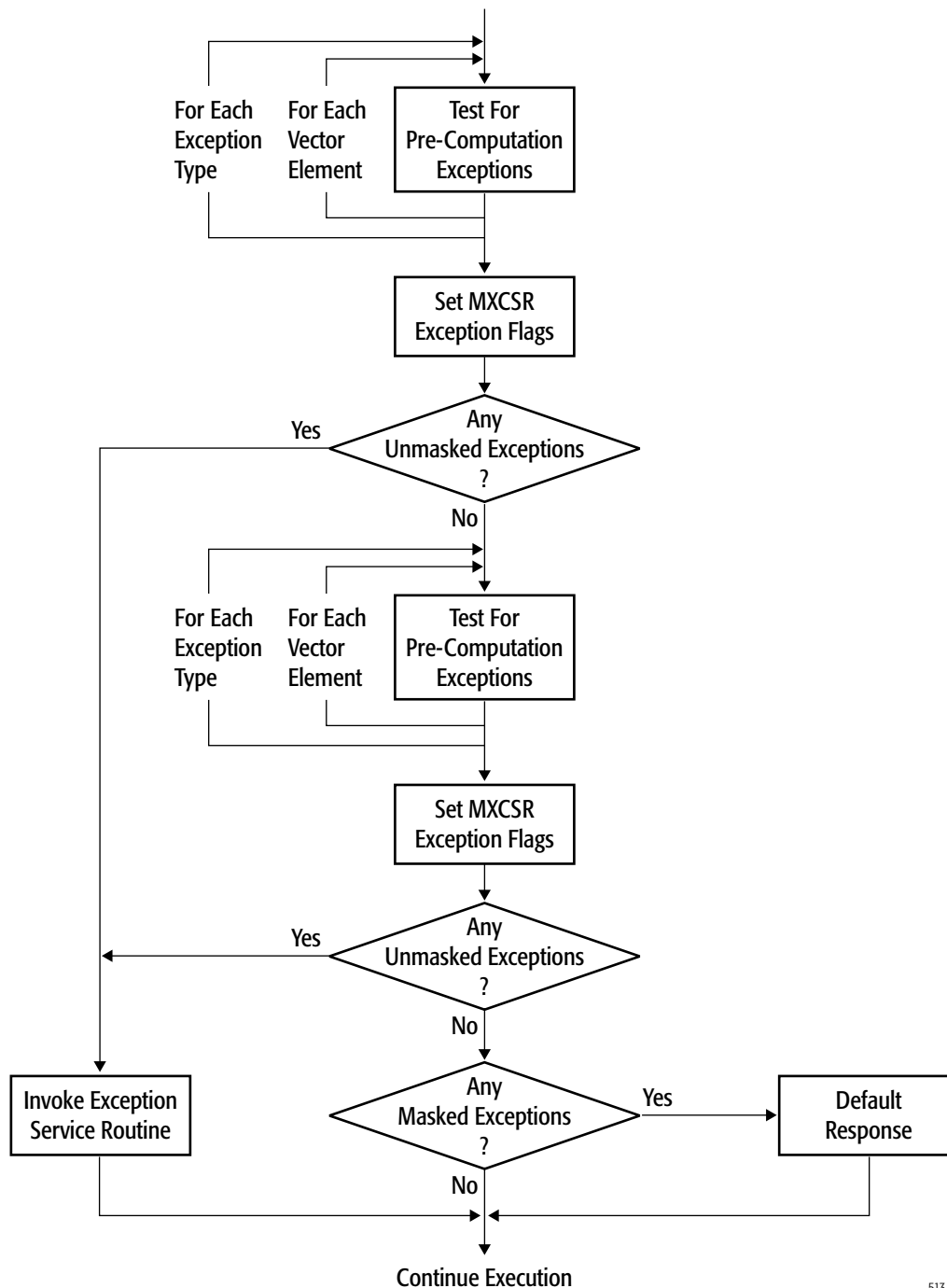

513-188.eps

Figure 4-38. SIMD Floating-Point Detection Process

4.10.4 SIMD Floating-Point Exception Masking

The six floating-point exception flags have corresponding exception-flag masks in the MXCSR register, as shown in Table 4-14.

Table 4-14. SIMD Floating-Point Exception Masks

Exception Mask and Mnemonic	MXCSR Bit	Comparable IEEE 754 Exception
Invalid-operation exception mask (IM)	7	Invalid Operation
Denormalized-operand exception mask (DM)	8	<i>none</i>
Zero-divide exception mask (ZM)	9	Division by Zero
Overflow exception mask (OM)	10	Overflow
Underflow exception mask (UM)	11	Underflow
Precision exception mask (PM)	12	Inexact

Each mask bit, when set to 1, inhibits invocation of the exception handler for that exception and instead causes a default response. Thus, an unmasked exception is one that invokes its exception handler when it occurs, whereas a masked exception continues normal execution using the default response for the exception type. During power-on initialization, all exception-mask bits in the MXCSR register are set to 1 (masked).

Masked Responses. The occurrence of a masked exception does not invoke its exception handler when the exception condition occurs. Instead, the processor handles masked exceptions in a default way, as shown in Table 4-15 on page 227.

Table 4-15. Masked Responses to SIMD Floating-Point Exceptions

Exception	Operation ¹		Processor Response ²
Invalid-operation exception (IE)	Any of the following, in which one or both operands is an SNaN: <ul style="list-style-type: none"> • Addition (ADDPS, ADDPD, ADDSS, ADDSD, ADDSUBPD, ADDSUBPS, HADDPS, HADDPD), or • Subtraction (SUBPS, SUBPD, SUBSS, SUBSD, ADDSUBPD, ADDSUBPS, HSUBPD, HSUBPS), or • Multiplication (MULPS, MULPD, MULSS, MULSD), or • Division (DIVPS, DIVPD, DIVSS, DIVSD), or • Square-root (SQRTPS, SQRTPD, SQRTPS, SQRTSD), or • Data conversion of floating-point to floating-point (CVTTPS2PD, CVTPD2PS, CVTSS2SD, CVTSD2SS). 		Return a QNaN, based on the rules in Table 4-6 on page 160.
	<ul style="list-style-type: none"> • Addition of infinities with opposite sign (ADDPS, ADDPD, ADDSS, ADDSD, ADDSUBPS, ADDSUBPD, HADDPS, HADDPD), or • Subtraction of infinities with same sign (SUBPS, SUBPD, SUBSS, SUBSD, ADDSUBPS, ADDSUBPD, HSUBPS, HSUBPD), or • Multiplication of zero by infinity (MULPS, MULPD, MULSS, MULSD), or • Division of zero by zero or infinity by infinity (DIVPS, DIVPD, DIVSS, DIVSD), or • Square-root in which the operand is non-zero negative (SQRTPS, SQRTPD, SQRTPS, SQRTSD). 		Return the floating-point indefinite value.
	Any of the following, in which one or both operands is a NaN: <ul style="list-style-type: none"> • Maximum or Minimum (MAXPS, MAXPD, MAXSS, MAXSD, MINPS, MINPD, MINSS, MINS), or • Compare (CMPPS, CMPPD, CMPSS, CMPSD, COMISS, COMISD). 		Return second source operand.
	Compare, in which one or both operands is a NaN (CMPPS, CMPPD, CMPSS, CMPSD).	Compare is unordered or not-equal	Return mask of all 1s.
		All other compares	Return mask of all 0s.

Notes:

1. For complete details about operations, see “SIMD Floating-Point Exception Causes” on page 219.
2. In all cases, the processor sets the associated exception flag in MXCSR. For details about number representation, see “Floating-Point Number Representation” on page 157 and “Floating-Point Number Encodings” on page 160.
3. This response does not comply with the IEEE 754 standard, but it offers higher performance.

Table 4-15. Masked Responses to SIMD Floating-Point Exceptions (continued)

Exception	Operation ¹		Processor Response ²
Invalid-operation exception (IE)	Ordered or unordered scalar compare, in which one or both operands is a NaN (COMISS, COMISD, UCOMISS, UCOMISD).		Set the zero (ZF), parity (PF), and carry (CF) flags in rFLAGS. Clear the overflow (OF), sign (SF), and auxiliary carry (AF) flags in rFLAGS.
	Data conversion from floating-point to integer, in which source operand is a NaN, infinity, or is larger than the representable value of the destination (CVTPS2PI, CVTPD2PI, CVTSS2SI, CVTSD2SI, CVTPS2DQ, CVTPD2DQ, CVTTPS2PI, CVTTPD2PI, CVTTPD2DQ, CVTTPS2DQ, CVTTSS2SI, CVTTSD2SI).		Return the integer indefinite value.
Denormalized-operand exception (DE)	One or both operands is denormal		Return the result using the denormal operand(s).
Zero-divide exception (ZE)	Divide (DIVx) zero with non-zero finite dividend		Return signed infinity, with sign bit = XOR of the operand sign bits.
Overflow exception (OE)	Overflow when rounding mode = round to nearest	Sign of result is positive	Return $+\infty$.
		Sign of result is negative	Return $-\infty$.
	Overflow when rounding mode = round toward $+\infty$	Sign of result is positive	Return $+\infty$.
		Sign of result is negative	Return finite negative number with largest magnitude.
	Overflow when rounding mode = round toward $-\infty$	Sign of result is positive	Return finite positive number with largest magnitude.
		Sign of result is negative	Return $-\infty$.
	Overflow when rounding mode = round toward 0	Sign of result is positive	Return finite positive number with largest magnitude.
		Sign of result is negative	Return finite negative number with largest magnitude.
Notes:			
1. For complete details about operations, see “SIMD Floating-Point Exception Causes” on page 219.			
2. In all cases, the processor sets the associated exception flag in MXCSR. For details about number representation, see “Floating-Point Number Representation” on page 157 and “Floating-Point Number Encodings” on page 160.			
3. This response does not comply with the IEEE 754 standard, but it offers higher performance.			

Table 4-15. Masked Responses to SIMD Floating-Point Exceptions (continued)

Exception	Operation ¹		Processor Response ²
Underflow exception (UE)	Inexact denormalized result	MXCSR flush-to-zero (FZ) bit = 0	Set PE flag and return denormalized result.
		MXCSR flush-to-zero (FZ) bit = 1	Set PE flag and return zero, with sign of true result. ³
Precision exception (PE)	Inexact normalized or denormalized result	Without OE or UE exception	Return rounded result.
		With masked OE or UE exception	Respond as for OE or UE exception.
		With unmasked OE or UE exception	Respond as for OE or UE exception, and invoke SIMD exception handler.

Notes:

- For complete details about operations, see “SIMD Floating-Point Exception Causes” on page 219.
- In all cases, the processor sets the associated exception flag in MXCSR. For details about number representation, see “Floating-Point Number Representation” on page 157 and “Floating-Point Number Encodings” on page 160.
- This response does not comply with the IEEE 754 standard, but it offers higher performance.

Unmasked Responses. If the processor detects an unmasked exception, it sets the associated exception flag in the MXCSR register and invokes the SIMD floating-point exception handler. The processor does not write a result or change any of the source operands for any type of unmasked exception. The exception handler must determine which exception occurred (by examining the exception flags in the MXCSR register) and take appropriate action.

In all cases of unmasked exceptions, before calling the exception handler, the processor examines the CR4.OSXMMEXCPT bit to see if it is set to 1. If it is set, the processor calls the #XF exception (vector 19). If it is cleared, the processor calls the #UD exception (vector 6). See “System-Control Registers” in Volume 2 for details.

For details about the operations that can cause unmasked exceptions, see “SIMD Floating-Point Exception Causes” on page 219 and Table 4-15.

Using NaNs in IE Diagnostic Exceptions. Both SNaNs and QNaNs can be encoded with many different values to carry diagnostic information. By means of appropriate masking and unmasking

of the invalid-operation exception (IE), software can use signaling NaNs to invoke an exception handler. Within the constraints imposed by the encoding of SNaNs and QNaNs, software may freely assign the bits in the significand of a NaN. See “Not a Number (NaN)” on page 159 for format details.

For example, software can pre-load each element of an array with a signaling NaN that encodes the array index. When an application accesses an uninitialized array element, the invalid-operation exception is invoked and the service routine can identify that element. A service routine can store debug information in memory as the exceptions occur. The routine can create a QNaN that references its associated debug area in memory. As the program runs, the service routine can create a different QNaN for each error condition, so that a single test-run can identify a collection of errors.

4.11 Saving, Clearing, and Passing State

4.11.1 Saving and Restoring State

In general, system software should save and restore 128-bit media state between task switches or other interventions in the execution of 128-bit media procedures. Virtually all modern operating systems running on x86 processors—like Windows NT®, UNIX, and OS/2—are preemptive multitasking operating systems that handle such saving and restoring of state properly across task switches, independently of hardware task-switch support. However, application procedures are also free to save and restore 128-bit media state at any time they deem useful.

Software running at any privilege level may save and restore 128-bit media state by executing the FXSAVE instruction, which saves not only 128-bit media state but also x87 floating-point state. Alternatively, software may use multiple move instructions for saving only the contents of selected 128-bit media data registers, or the STMXCSR instruction for saving the MXCSR register state. For details, see “Save and Restore State” on page 191.

4.11.2 Parameter Passing

128-bit media procedures can use MOV x instructions to pass data to other such procedures. This can be done directly, via the XMM registers, or indirectly by storing data on the procedure stack. When storing to the stack, software should use the rSP register for the memory address and, after the save, explicitly

decrement rSP by 16 for each 128-bit XMM register parameter stored on the stack. Likewise, to load a 128-bit XMM register from the stack, software should increment rSP by 16 after the load. There is a choice of MOVx instructions designed for aligned and unaligned moves, as described in “Data Transfer” on page 166 and “Data Transfer” on page 192.

The processor does not check the data type of instruction operands prior to executing instructions. It only checks them at the point of execution. For example, if the processor executes an arithmetic instruction that takes double-precision operands but is provided with single-precision operands by MOVx instructions, the processor will first convert the operands from single precision to double precision prior to executing the arithmetic operation, and the result will be correct. However, the required conversion may cause degradation of performance.

Because of this possibility of data-type mismatching between MOVx instructions used to pass parameters and the instructions in the called procedure that subsequently operate on the moved data, the calling procedure should save its own state prior to the call. The called procedure cannot determine the caller’s data types, and thus it cannot optimize its choice of instructions for storing a caller’s state.

For further information, see the software optimization documentation for particular hardware implementations.

4.11.3 Accessing Operands in MMX™ Registers

Software may freely mix 128-bit media instructions (integer or floating-point) with 64-bit media instructions (integer or floating-point) and general-purpose instructions in a single procedure. There are no restrictions on transitioning from 128-bit media procedures to x87 procedures, except when a 128-bit media procedure accesses an MMX register by means of a data-transfer or data-conversion instruction.

In such cases, software should separate such procedures or dynamic link libraries (DLLs) from x87 floating-point procedures or DLLs by clearing the MMX state with the EMMS instruction, as described in “Exit Media State” on page 255. For further details, see “Mixing Media Code with x87 Code” on page 286.

4.12 Performance Considerations

In addition to typical code optimization techniques, such as those affecting loops and the inlining of function calls, the following considerations may help improve the performance of application programs written with 128-bit media instructions.

These are implementation-independent performance considerations. Other considerations depend on the hardware implementation. For information about such implementation-dependent considerations and for more information about application performance in general, see the data sheets and the software-optimization guides relating to particular hardware implementations.

4.12.1 Use Small Operand Sizes

The performance advantages available with 128-bit media operations is to some extent a function of the data sizes operated upon. The smaller the data size, the more data elements that can be packed into single 128-bit vectors. The parallelism of computation increases as the number of elements per vector increases.

4.12.2 Reorganize Data for Parallel Operations

Much of the performance benefit from the 128-bit media instructions comes from the parallelism inherent in vector operations. It can be advantageous to reorganize data before performing arithmetic operations so that its layout after reorganization maximizes the parallelism of the arithmetic operations.

The speed of memory access is particularly important for certain types of computation, such as graphics rendering, that depend on the regularity and locality of data-memory accesses. For example, in matrix operations, performance is high when operating on the rows of the matrix, because row bytes are contiguous in memory, but lower when operating on the columns of the matrix, because column bytes are not contiguous in memory and accessing them can result in cache misses. To improve performance for operations on such columns, the matrix should first be transposed. Such transpositions can, for example, be done using a sequence of unpacking or shuffle instructions.

4.12.3 Remove Branches

Branch can be replaced with 128-bit media instructions that simulate predicated execution or conditional moves, as described in “Branch Removal” on page 141. The branch can be

replaced with 128-bit media instructions that simulate predicated execution or conditional moves. Figure 4-10 on page 142 shows an example of a non-branching sequence that implements a two-way multiplexer.

Where possible, break long dependency chains into several shorter dependency chains which can be executed in parallel. This is especially important for floating-point instructions because of their longer latencies.

4.12.4 **Use Streaming Stores**

The MOVNTDQ and MASKMOVDQU instructions store streaming (non-temporal) data to memory. These instructions indicate to the processor that the data they reference will be used only once and is therefore not subject to cache-related overhead (such as write-allocation). A typical case benefitting from streaming stores occurs when data written by the processor is never read by the processor, such as data written to a graphics frame buffer.

4.12.5 **Align Data**

Data alignment is particularly important for performance when data written by one instruction is read by a subsequent instruction soon after the write, or when accessing streaming (non-temporal) data. These cases may occur frequently in 128-bit media procedures.

Accesses to data stored at unaligned locations may benefit from on-the-fly software alignment or from repetition of data at different alignment boundaries, as required by different loops that process the data.

4.12.6 **Organize Data for Cacheability**

Pack small data structures into cache-line-size blocks. Organize frequently accessed constants and coefficients into cache-line-size blocks and prefetch them. Procedures that access data arranged in memory-bus-sized blocks, or memory-burst-sized blocks, can make optimum use of the available memory bandwidth.

For data that will be used only once in a procedure, consider using non-cacheable memory. Accesses to such memory are not burdened by the overhead of cache protocols.

4.12.7 **Prefetch Data**

Media applications typically operate on large data sets. Because of this, they make intensive use of the memory bus. Memory latency can be substantially reduced—especially for data that will be used only once—by prefetching such data into various levels of the cache hierarchy. Software can use the

PREFETCHx instructions very effectively in such cases, as described in “Cache and Memory Management” on page 80.

Some of the best places to use prefetch instructions are inside loops that process large amounts of data. If the loop goes through less than one cache line of data per iteration, partially unroll the loop. Try to use virtually all of the prefetched data. This usually requires unit-stride memory accesses—those in which all accesses are to contiguous memory locations. Exactly one PREFETCHx instruction per cache line must be used. For further details, see the *Optimization Guide for AMD Athlon™ 64 and AMD Opteron™ Processors*, order# 25112.

4.12.8 Use 128-Bit Media Code for Moving Data

Movements of data between memory, GPR, XMM, and MMX registers can take advantage of the parallel vector operations supported by the 128-bit media MOVx instructions. Figure 4-6 on page 138 illustrates the range of move operations available.

4.12.9 Retain Intermediate Results in XMM Registers

Keep intermediate results in the XMM registers as much as possible, especially if the intermediate results are used shortly after they have been produced. Avoid spilling intermediate results to memory and reusing them shortly thereafter. In 64-bit mode, the architecture’s 16 XMM registers offer twice the number of legacy XMM registers.

4.12.10 Replace GPR Code with 128-bit media Code.

In 64-bit mode, the AMD64 architecture provides twice the number of general-purpose registers (GPRs) as the legacy x86 architecture, thereby reducing potential pressure on GPRs. Nevertheless, general-purpose instructions do not operate in parallel on vectors of elements, as do 128-bit media instructions. Thus, 128-bit media code supports parallel operations and can perform better with algorithms and data that are organized for parallel operations.

4.12.11 Replace x87 Code with 128-Bit Media Code

One of the most useful advantages of 128-bit media instructions is the ability to intermix integer and floating-point instructions in the same procedure, using a register set that is separate from the GPR, MMX, and x87 register sets. Code written with 128-bit media floating-point instructions can operate in parallel on four times as many single-precision floating-point operands as can x87 floating-point code. This achieves potentially four times the computational work of x87 instructions that take single-precision operands. Also, the higher density of 128-bit media floating-point operands may make it possible to remove local temporary variables that would otherwise be needed in x87

floating-point code. 128-bit media code is also easier to write than x87 floating-point code, because the XMM register file is flat, rather than stack-oriented, and in 64-bit mode there are twice the number of XMM registers as x87 registers. Moreover, when integer and floating-point instructions must be used together, 128-bit media floating-point instructions avoid the potential need to save and restore state between integer operations and floating-point procedures.

5 64-Bit Media Programming

This chapter describes the 64-bit media programming model. This model includes all instructions that access the MMX™ registers, including the MMX and 3DNow!™ instructions plus some SSE and SSE2 instructions.

The 64-bit media instructions perform integer and floating-point operations primarily on vector operands (a few of the instructions take scalar operands). The MMX integer operations produce signed, unsigned, and/or saturating results. The 3DNow! floating-point operations take single-precision operands and produce saturating results without generating floating-point exceptions. The instructions that take vector operands can speed up certain types of procedures by significant factors, depending on data-element size and the regularity and locality of data accesses to memory.

The term *64-bit* is used in two different contexts within the AMD64 architecture: the 64-bit media instructions, described in this chapter, and the 64-bit operating mode, described in “64-Bit Mode” on page 8.

5.1 Origins

The 64-bit media instructions were introduced in the following extensions to the legacy x86 architecture:

- *MMX Instructions*—These are primarily integer instructions that use primarily vector operands in 64-bit MMX registers or memory locations.
- *3DNow! Instructions*—These are primarily floating-point instructions that use primarily vector operands in MMX registers or memory locations.
- *SSE, SSE2, and SSE3 Instructions*—These are the streaming SIMD extensions (SSE), SSE2, and SSE3 instructions. Some of them perform conversions between operands in the 64-bit MMX register set and other register sets.

For details on the extension-set origin of each instruction, see “Instruction Subsets and CPUID Feature Sets” in Volume 3.

5.2 Compatibility

64-bit media instructions can be executed in any of the architecture's operating modes. Existing MMX and 3DNow! binary programs run in legacy and compatibility modes without modification. The support provided by the AMD64 architecture for such binaries is identical to that provided by legacy x86 architectures.

To run in 64-bit mode, 64-bit media programs must be recompiled. The recompilation has no side effects on such programs, other than to make available the extended general-purpose registers and 64-bit virtual address space.

The MMX and 3DNow! instructions introduce no additional registers, status bits, or other processor state to the legacy x86 architecture. Instead, they use the x87 floating-point registers that have long been a part of most x86 architectures. Because of this, 64-bit media procedures require no special operating-system support or exception handlers. When state-saves are required between procedures, the same instructions that system software uses to save and restore x87 floating-point state also save and restore the 64-bit media-programming state.

5.3 Capabilities

The 64-bit media instructions are designed to support multimedia and communication applications that operate on vectors of small-sized data elements. For example, 8-bit and 16-bit integer data elements are commonly used for pixel information in graphics applications, and 16-bit integer data elements are used for audio sampling. The 64-bit media instructions allow multiple data elements like these to be packed into single 64-bit vector operands located in an MMX register or in memory. The instructions operate in parallel on each of the elements in these vectors. For example, 8-bit integer data can be packed in vectors of eight elements in a single 64-bit register, so that all eight byte elements are operated on simultaneously by a single instruction.

Typical applications of the 64-bit media integer instructions include music synthesis, speech synthesis, speech recognition, audio and video compression (encoding) and decompression (decoding), 2D and 3D graphics (including 3D texture mapping), and streaming video. Typical applications of the 64-

bit media floating-point instructions include digital signal processing (DSP) kernels and front-end 3D graphics algorithms, such as geometry, clipping, and lighting.

These types of applications are referred to as *media* applications. Such applications commonly use small data elements in repetitive loops, in which the typical operations are inherently parallel. In 256-color video applications, for example, 8-bit operands in 64-bit MMX registers can be used to compute transformations on eight pixels per instruction.

5.3.1 Parallel Operations

Most of the 64-bit media instructions perform parallel operations on vectors of operands. *Vector* operations are also called *packed* or *SIMD* (single-instruction, multiple-data) operations. They take operands consisting of multiple elements and operate on all elements in parallel. Figure 5-1 shows an example of an integer operation on two vectors, each containing 16-bit (word) elements. There are also 64-bit media instructions that operate on vectors of byte or doubleword elements.

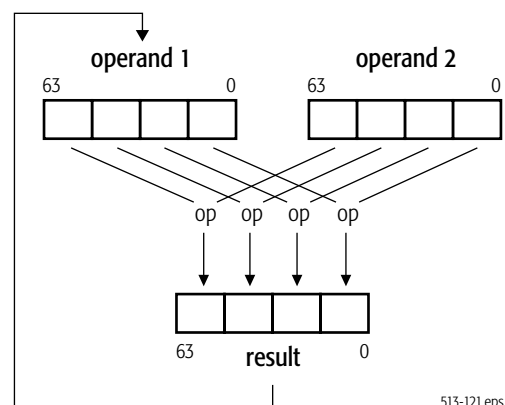

513-121.eps

Figure 5-1. Parallel Integer Operations on Elements of Vectors

5.3.2 Data Conversion and Reordering

The 64-bit media instructions support conversions of various integer data types to floating-point data types, and vice versa.

There are also instructions that reorder vector-element ordering or the bit-width of vector elements. For example, the unpack instructions take two vector operands and interleave their low or high elements. Figure 5-2 on page 240 shows an unpack operation (PUNPCKLWD) that interleaves low-order

elements of each source operand. If each element of operand 2 has the value zero, the operation zero-extends each element of operand 1 to twice its original width. This may be useful, for example, prior to an arithmetic operation in which the data-conversion result must be paired with another source operand containing vector elements that are twice the width of the pre-conversion (half-size) elements. There are also pack instructions that convert each element of 2x size in a pair of vectors to elements of 1x size, with saturation at maximum and minimum values.

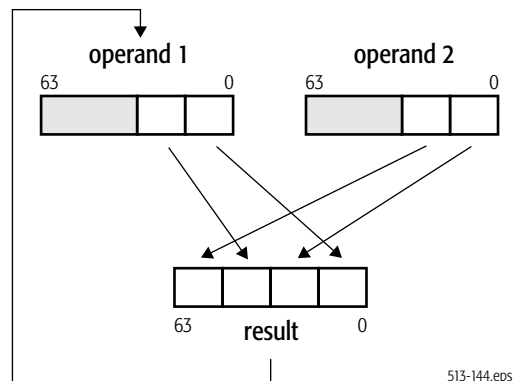

Figure 5-2. Unpack and Interleave Operation

Figure 5-3 on page 241 shows a shuffle operation (PSHUFW), in which one of the operands provides vector data, and an immediate byte provides shuffle control for up to 256 permutations of the data.

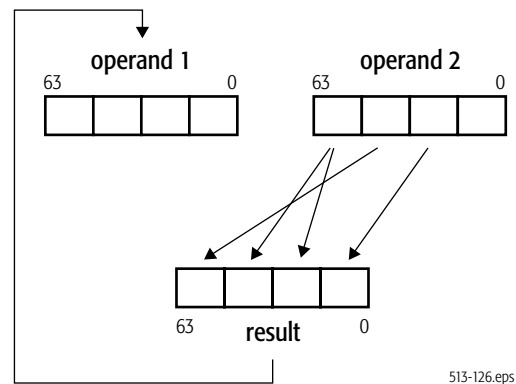

Figure 5-3. Shuffle Operation (1 of 256)

5.3.3 Matrix Operations

Media applications often multiply and accumulate vector and matrix data. In 3D graphics applications, for example, objects are typically represented by triangles, each of whose vertices are located in 3D space by a matrix of coordinate values, and matrix transforms are performed to simulate object movement.

64-bit media integer and floating-point instructions can perform several types of matrix-vector or matrix-matrix operations, such as addition, subtraction, multiplication, and accumulation. The integer instructions can also perform multiply-accumulate operations. Efficient matrix multiplication is further supported with instructions that can first transpose the elements of matrix rows and columns. These transpositions can make subsequent accesses to memory or cache more efficient when performing arithmetic matrix operations.

Figure 5-4 on page 242 shows a vector multiply-add instruction (PMADDWD) that multiplies vectors of 16-bit integer elements to yield intermediate results of 32-bit elements, which are then summed pair-wise to yield two 32-bit elements.

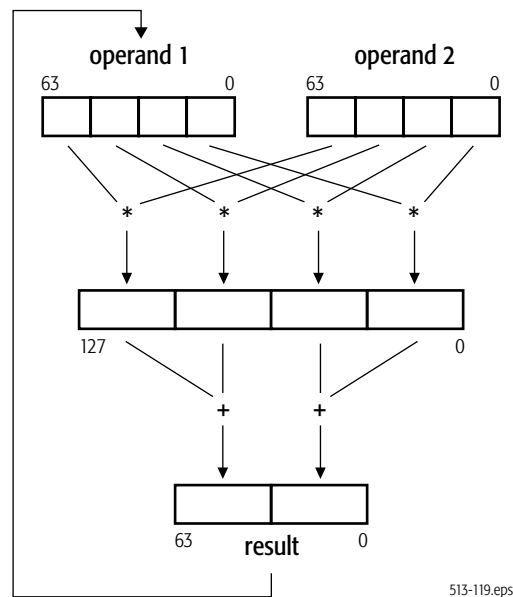

Figure 5-4. Multiply-Add Operation

The operation shown in Figure 5-4 can be used together with transpose and vector-add operations (see “Addition” on page 263) to accumulate *dot product* results (also called *inner* or *scalar products*), which are used in many media algorithms.

5.3.4 Saturation

Several of the 64-bit media integer instructions and most of the 64-bit media floating-point instructions produce vector results in which each element *saturates* independently of the other elements in the result vector. Such results are clamped (limited) to the maximum or minimum value representable by the destination data type when the true result exceeds that maximum or minimum representable value.

Saturation avoids the need for code that tests for potential overflow or underflow. Saturating data is useful for representing physical-world data, such as sound and color. It is used, for example, when combining values for pixel coloring.

5.3.5 Branch Removal

Branching is a time-consuming operation that, unlike most 64-bit media vector operations, does not exhibit parallel behavior (there is only one branch target, not multiple targets, per branch instruction). In many media applications, a branch involves selecting between only a few (often only two) cases.

Such branches can be replaced with 64-bit media vector compare and vector logical instructions that simulate predicated execution or conditional moves.

Figure 5-5 shows an example of a non-branching sequence that implements a two-way multiplexer—one that is equivalent to the ternary operator “?:” in C and C++. The comparable code sequence is explained in “Compare and Write Mask” on page 270.

The sequence in Figure 5-5 begins with a vector compare instruction that compares the elements of two source operands in parallel and produces a mask vector containing elements of all 1s or 0s. This mask vector is ANDed with one source operand and ANDed-Not with the other source operand to isolate the desired elements of both operands. These results are then Ored to select the relevant elements from each operand. A similar branch-removal operation can be done using floating-point source operands.

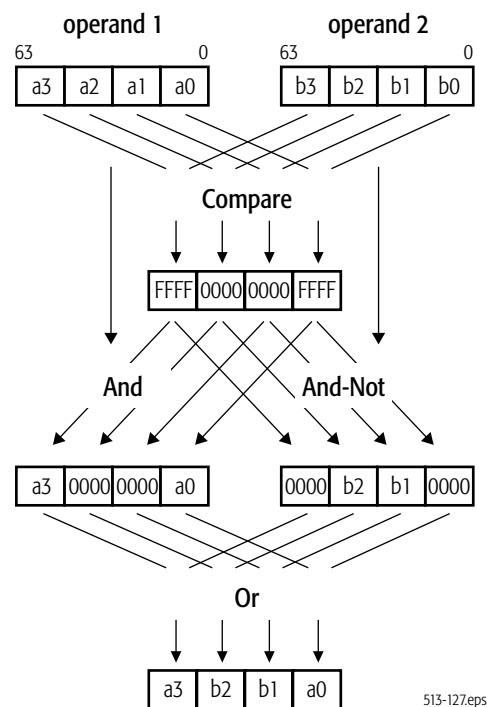

Figure 5-5. Branch-Removal Sequence

5.3.6 Floating-Point (3DNow!™) Vector Operations

Floating-point vector instructions using the MMX registers were introduced by AMD with the 3DNow! technology. These instructions take 64-bit vector operands consisting of two 32-bit single-precision floating-point numbers, shown as *FP single* in Figure 5-6.

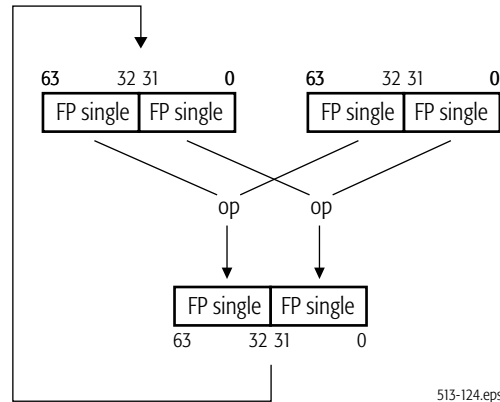

Figure 5-6. Floating-Point (3DNow!™ Instruction) Operations

The AMD64 architecture's 3DNow! floating-point instructions provide a unique advantage over legacy x87 floating-point instructions: They allow integer *and* floating-point instructions to be intermixed in the same procedure, using only the MMX registers. This avoids the need to switch between integer MMX procedures and x87 floating-point procedures—a switch that may involve time-consuming state saves and restores—while at the same time leaving the 128-bit XMM register resources free for other applications.

The 3DNow! instructions allow applications such as 3D graphics to accelerate front-end geometry, clipping, and lighting calculations. Picture and pixel data are typically integer data types, although both integer and floating-point instructions are often required to operate completely on the data. For example, software can change the viewing perspective of a 3D scene through transformation matrices by using floating-point instructions in the same procedure that contains integer operations on other aspects of the graphics data.

3DNow! programs typically perform better than x87 floating-point code, because the MMX register file is flat rather than

stack-oriented and because 3DNow! instructions can operate on twice as many operands as x87 floating-point instructions. This ability to operate in parallel on twice as many floating-point values in the same register space often makes it possible to remove local temporary variables in 3DNow! code that would otherwise be needed in x87 floating-point code.

5.4 Registers

5.4.1 MMX™ Registers Eight 64-bit MMX registers, *mmx0*–*mmx7*, support the 64-bit media instructions. Figure 5-7 shows these registers. They can hold operands for both vector and scalar operations on integer (MMX) and floating-point (3DNow!) data types.

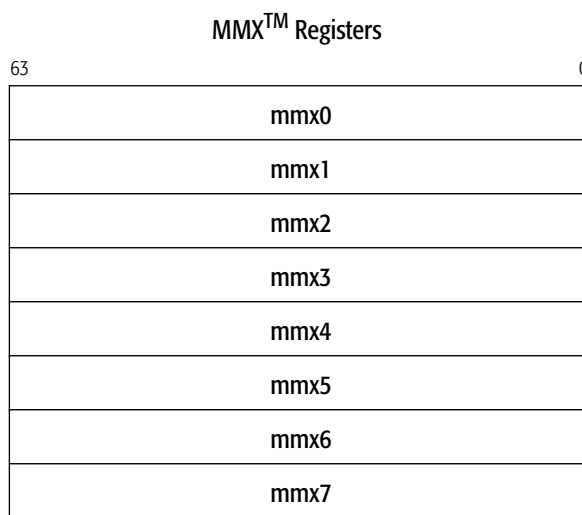

513-145.eps

Figure 5-7. 64-bit Media Registers

The MMX registers are mapped onto the low 64 bits of the 80-bit x87 floating-point physical data registers, FPR0–FPR7, described in “Registers” on page 295. However, the x87 stack register structure, ST(0)–ST(7), is not used by MMX instructions. The x87 tag bits, top-of-stack pointer (TOP), and high bits of the 80-bit FPR registers are changed when 64-bit media instructions are executed. For details about the x87-related actions performed by hardware during execution of 64-

bit media instructions, see “Actions Taken on Executing 64-Bit Media Instructions” on page 284.

5.4.2 Other Registers

Some 64-bit media instructions that perform data transfer, data conversion or data reordering operations (“Data Transfer” on page 256, “Data Conversion” on page 258, and “Data Conversion” on page 274) can access operands in the general-purpose registers (GPRs) or XMM registers. When addressing GPRs or XMM registers in 64-bit mode, the REX instruction prefix can be used to access the extended GPRs or XMM registers, as described in “REX Prefixes” on page 91. For a description of the GPR registers, see “Registers” on page 27. For a description of the XMM registers, see “XMM Registers” on page 143.

5.5 Operands

Operands for a 64-bit media instruction are either referenced by the instruction's opcode or included as an immediate value in the instruction encoding. Depending on the instruction, referenced operands can be located in registers or memory. The data types of these operands include vector and scalar integer, and vector floating-point.

5.5.1 Data Types

Figure 5-8 on page 247 shows the register images of the 64-bit media data types. These data types can be interpreted by instruction syntax and/or the software context as one of the following types of values:

- Vector (packed) single-precision (32-bit) floating-point numbers.
- Vector (packed) signed (two's-complement) integers.
- Vector (packed) unsigned integers.
- Scalar signed (two's-complement) integers.
- Scalar unsigned integers.

Hardware does not check or enforce the data types for instructions. Software is responsible for ensuring that each operand for an instruction is of the correct data type. Software can interpret the data types in ways other than those shown in Figure 5-8 on page 247—such as bit fields or fractional numbers—but the 64-bit media instructions do not directly support such interpretations and software must handle them entirely on its own.

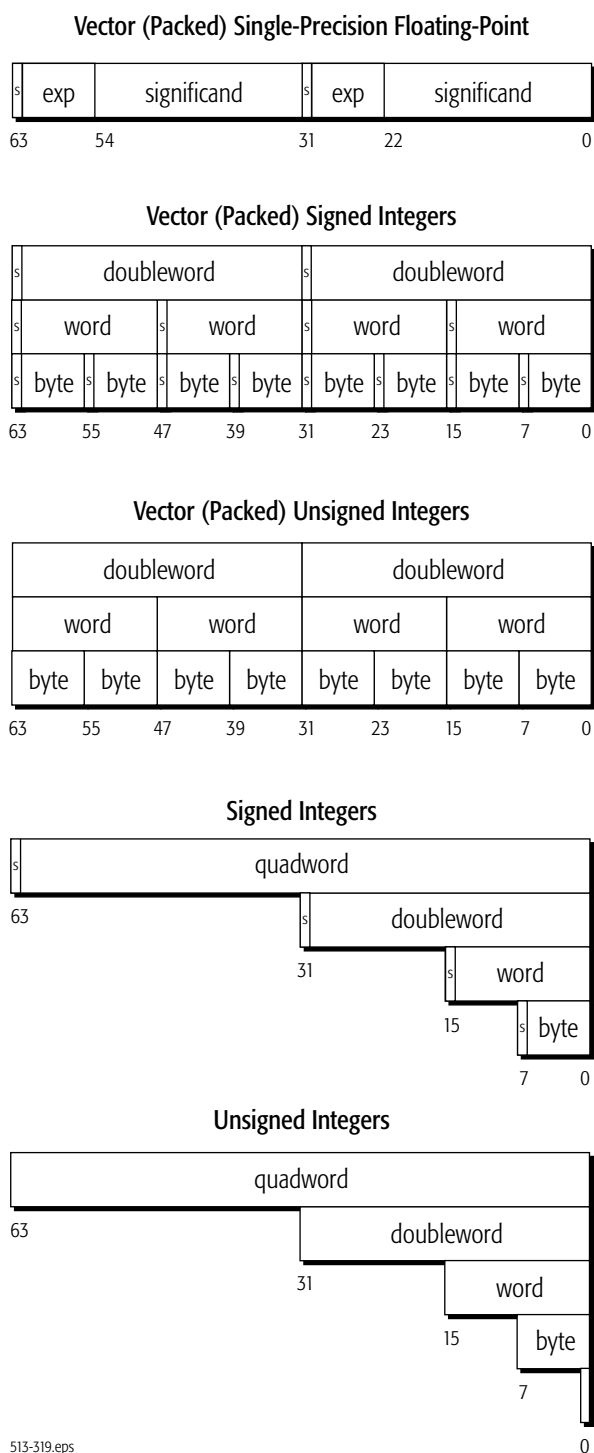

Figure 5-8. 64-Bit Media Data Types

5.5.2 Operand Sizes and Overrides

Operand sizes for 64-bit media instructions are determined by instruction opcodes. Some of these opcodes include an operand-size override prefix, but this prefix acts in a special way to modify the opcode and is considered an integral part of the opcode. The general use of the 66h operand-size override prefix described in “Instruction Prefixes” on page 87 does not apply to 64-bit media instructions.

For details on the use of operand-size override prefixes in 64-bit media instructions, see the opcodes in “64-Bit Media Instruction Reference” in Volume 5.

5.5.3 Operand Addressing

Depending on the 64-bit media instruction, referenced operands may be in registers or memory.

Register Operands. Most 64-bit media instructions can access source and destination operands located in MMX registers. A few of these instructions access the XMM or GPR registers. When addressing GPR or XMM registers in 64-bit mode, the REX instruction prefix can be used to access the extended GPR or XMM registers, as described in “Instruction Prefixes” on page 280.

The 64-bit media instructions do not access the rFLAGS register, and none of the bits in that register are affected by execution of the 64-bit media instructions.

Memory Operands. Most 64-bit media instructions can read memory for source operands, and a few of the instructions can write results to memory. “Memory Addressing” on page 16, describes the general methods and conditions for addressing memory operands.

Immediate Operands. Immediate operands are used in certain data-conversion and vector-shift instructions. Such instructions take 8-bit immediates, which provide control for the operation.

I/O Ports. I/O ports in the I/O address space cannot be directly addressed by 64-bit media instructions, and although memory-mapped I/O ports can be addressed by such instructions, doing so may produce unpredictable results, depending on the hardware implementation of the architecture. See the data sheet or software-optimization documentation for particular hardware implementations.

5.5.4 Data Alignment

Those 64-bit media instructions that access a 128-bit operand in memory incur a general-protection exception (#GP) if the operand is not aligned to a 16-byte boundary. These instructions include:

- CVTPD2PI—Convert Packed Double-Precision Floating-Point to Packed Doubleword Integers.
- CVTTPD2PI—Convert Packed Double-Precision Floating-Point to Packed Doubleword Integers, Truncated.
- FXRSTOR—Restore XMM, MMX, and x87 State.
- FXSAVE—Save XMM, MMX, and x87 State.

For other 64-bit media instructions, the architecture does not impose data-alignment requirements for accessing 64-bit media data in memory. Specifically, operands in physical memory do not need to be stored at addresses which are even multiples of the operand size, in bytes. However, the consequence of storing operands at unaligned locations is that accesses to those operands may require more processor and bus cycles than for aligned accesses. See “Data Alignment” on page 48 for details.

5.5.5 Integer Data Types

Most of the MMX instructions support operations on the integer data types shown in Figure 5-8. These instructions are summarized in “Instruction Summary—Integer Instructions” on page 253. The characteristics of these data types are described below.

Sign. Many of the 64-bit media instructions have variants for operating on signed or unsigned integers. For signed integers, the sign bit is the most-significant bit—bit 7 for a byte, bit 15 for a word, bit 31 for a doubleword, or bit 63 for a quadword. Arithmetic instructions that are not specifically named as unsigned perform signed two’s-complement arithmetic.

Maximum and Minimum Representable Values. Table 5-1 on page 250 shows the range of representable values for the integer data types.

Table 5-1. Range of Values in 64-Bit Media Integer Data Types

Data-Type Interpretation		Byte	Word	Doubleword	Quadword
Unsigned integers	Base-2 (exact)	0 to $+2^8-1$	0 to $+2^{16}-1$	0 to $+2^{32}-1$	0 to $+2^{64}-1$
	Base-10 (approx.)	0 to 255	0 to 65,535	0 to $4.29 * 10^9$	0 to $1.84 * 10^{19}$
Signed integers ¹	Base-2 (exact)	-2^7 to $+(2^7-1)$	-2^{15} to $+(2^{15}-1)$	-2^{31} to $+(2^{31}-1)$	-2^{63} to $+(2^{63}-1)$
	Base-10 (approx.)	-128 to +127	-32,768 to +32,767	$-2.14 * 10^9$ to $+2.14 * 10^9$	$-9.22 * 10^{18}$ to $+9.22 * 10^{18}$

Saturation. Saturating (also called limiting or clamping) instructions limit the value of a result to the maximum or minimum value representable by the destination data type. Saturating versions of integer vector-arithmetic instructions operate on byte-sized and word-sized elements. These instructions—for example, PADDs, PADDUS, PSUBS, and PSUBUS—saturate signed or unsigned data independently for each element in a vector when the element reaches its maximum or minimum representable value. Saturation avoids overflow or underflow errors.

The examples in Table 5-2 illustrate saturating and non-saturating results with word operands. Saturation for other data-type sizes follows similar rules. Once saturated, the saturated value is treated like any other value of its type. For example, if 0001h is subtracted from the saturated value, 7FFFh, the result is 7FFEh.

Table 5-2. Saturation Examples

Operation	Non-Saturated Infinitely Precise Result	Saturated Signed Result	Saturated Unsigned Result
7000h + 2000h	9000h	7FFFh	9000h
7000h + 7000h	E000h	7FFFh	E000h
F000h + F000h	1E000h	E000h	FFFFh
9000h + 9000h	12000h	8000h	FFFFh
7FFFh + 0100h	80FFh	7FFFh	80FFh
7FFFh + FF00h	17EFFh	7EFFh	FFFFh

Arithmetic instructions not specifically designated as saturating perform non-saturating, two's-complement arithmetic.

Rounding. There is a rounding version of the integer vector-multiply instruction, `PMULHRW`, that multiplies pairs of signed-integer word elements and then adds `8000h` to the lower word of the doubleword result, thus rounding the high-order word which is returned as the result.

Other Fixed-Point Operands. The architecture provides specific support only for integer fixed-point operands—those in which an implied binary point is located to the right of bit 0. Nevertheless, software may use fixed-point operands in which the implied binary point is located in any position. In such cases, software is responsible for managing the interpretation of such implied binary points, as well as any redundant sign bits that may occur during multiplication.

5.5.6 Floating-Point Data Types

All 64-bit media 3DNow! instructions, except `PFRCP` and `PFRSQRT`, take 64-bit vector operands. They operate in parallel on two single-precision (32-bit) floating-point values contained in those vectors.

Figure 5-9 shows the format of the vector operands. The characteristics of the single-precision floating-point data types are described below. The 64-bit floating-point media instructions are summarized in “Instruction Summary—Floating-Point Instructions” on page 273.

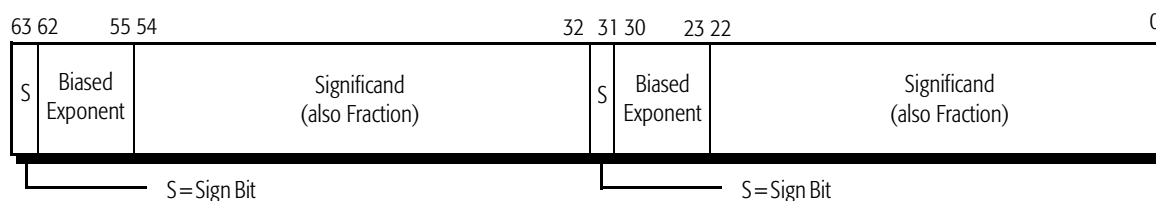

Figure 5-9. 64-Bit Floating-Point (3DNow!) Vector Operand

Single-Precision Format. The single-precision floating-point format supported by 64-bit media instructions is the same format as the normalized IEEE 754 single-precision format. This format includes a sign bit, an 8-bit biased exponent, and a 23-bit

significand with one hidden integer bit for a total of 24 bits in the significand. The hidden integer bit is assumed to have a value of 1, and the significand field is also the fraction. The bias of the exponent is 127. However, the 3DNow! format does not support other aspects of the IEEE 754 standard, such as multiple rounding modes, representation of numbers other than normalized numbers, and floating-point exceptions.

Range of Representable Values and Saturation. Table 5-3 shows the range of representable values for 64-bit media floating-point data. Table 5-4 shows the exponent ranges. The largest representable positive normal number has an exponent of FEh and a significand of 7FFFFFFh, with a numerical value of $2^{127} * (2 - 2^{-23})$. The smallest representable negative normal number has an exponent of 01h and a significand of 000000h, with a numerical value of 2^{-126} .

Table 5-3. Range of Values in 64-Bit Media Floating-Point Data Types

Data-Type Interpretation		Doubleword	Quadword
Floating-point	Base-2 (exact)	2^{-126} to $2^{127} * (2 - 2^{-23})$	Two single-precision floating-point doublewords
	Base-10 (approx.)	$1.17 * 10^{-38}$ to $+3.40 * 10^{38}$	

Table 5-4. 64-Bit Floating-Point Exponent Ranges

Biased Exponent	Description
FFh	Unsupported ¹
00h	Zero
00h<x<FFh	Normal
01h	$2^{(1-127)}$ lowest possible exponent
FEh	$2^{(254-127)}$ largest possible exponent

Note:
1. Unsupported numbers can be used as source operands but produce undefined results.

Results that, after rounding, overflow above the maximum-representable positive or negative number are saturated (limited or clamped) at the maximum positive or negative

number. Results that underflow below the minimum-representable positive or negative number are treated as zero.

Floating-Point Rounding. In contrast to the IEEE standard, which requires four rounding modes, the 64-bit media floating-point instructions support only one rounding mode, depending on the instruction. All such instructions use round-to-nearest, except certain floating-point-to-integer conversion instructions (“Data Conversion” on page 274) which use round-to-zero.

No Support for Infinities, NaNs, and Denormals. 64-bit media floating-point instructions support only normalized numbers. They do not support infinity, NaN, and denormalized number representations. Operations on such numbers produce undefined results, and no exceptions are generated. If all source operands are normalized numbers, these instructions never produce infinities, NaNs, or denormalized numbers as results.

This aspect of 64-bit media floating-point operations does not comply with the IEEE 754 standard. Software must use only normalized operands and ensure that computations remain within valid normalized-number ranges.

No Support for Floating-Point Exceptions. The 64-bit media floating-point instructions do not generate floating-point exceptions. Software must ensure that in-range operands are provided to these instructions.

5.6 Instruction Summary—Integer Instructions

This section summarizes the functions of the integer (MMX and a few SSE and SSE2) instructions in the 64-bit media instruction subset. These include integer instructions that use an MMX register for source or destination and data-conversion instructions that convert from integers to floating-point formats. For a summary of the floating-point instructions in the 64-bit media instruction subset, including data-conversion instructions that convert from floating-point to integer formats, see “Instruction Summary—Floating-Point Instructions” on page 273.

The instructions are organized here by functional group—such as data-transfer, vector arithmetic, and so on. Software running at any privilege level can use any of these instructions, if the

CPUID instruction reports support for the instructions (see “Feature Detection” on page 281). More detail on individual instructions is given in the alphabetically organized “64-Bit Media Instruction Reference” in Volume 5.

5.6.1 Syntax

Each instruction has a *mnemonic syntax* used by assemblers to specify the operation and the operands to be used for source and destination (result) data. The majority of 64-bit media integer instructions have the following syntax:

```
MNEMONIC mmx1, mmx2/mem64
```

Figure 5-10 shows an example of the mnemonic syntax for a packed add bytes (PADDB) instruction.

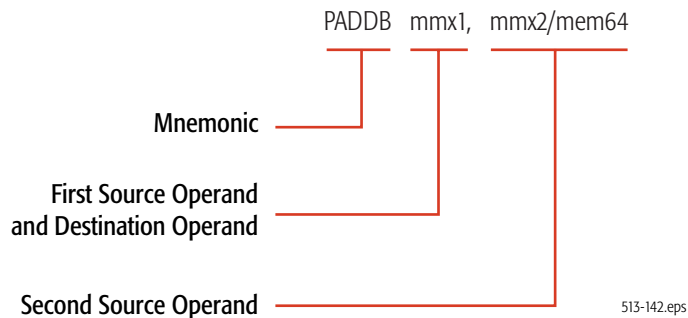

Figure 5-10. Mnemonic Syntax for Typical Instruction

This example shows the PADDB mnemonic followed by two operands, a 64-bit MMX register operand and another 64-bit MMX register or 64-bit memory operand. In most instructions that take two operands, the first (left-most) operand is both a source operand and the destination operand. The second (right-most) operand serves only as a source. Some instructions can have one or more prefixes that modify default properties, as described in “Instruction Prefixes” on page 280.

Mnemonics. The following characters are used as prefixes in the mnemonics of integer instructions:

- **CVT**—Convert
- **CVTT**—Convert with truncation
- **P**—Packed (vector)
- **PACK**—Pack elements of 2x data size to 1x data size
- **PUNPCK**—Unpack and interleave elements

In addition to the above prefix characters, the following characters are used elsewhere in the mnemonics of integer instructions:

- **B**—Byte
- **D**—Doubleword
- **DQ**—Double quadword
- **ID**—Integer doubleword
- **IW**—Integer word
- **PD**—Packed double-precision floating-point
- **PI**—Packed integer
- **PS**—Packed single-precision floating-point
- **Q**—Quadword
- **S**—Signed
- **SS**—Signed saturation
- **U**—Unsigned
- **US**—Unsigned saturation
- **W**—Word
- **x**—One or more variable characters in the mnemonic

For example, the mnemonic for the instruction that packs four words into eight unsigned bytes is **PACKUSWB**. In this mnemonic, the **PACK** designates 2x-to-1x conversion of vector elements, the **US** designates unsigned results with saturation, and the **WB** designates vector elements of the source as words and those of the result as bytes.

5.6.2 Exit Media State

The exit media state instructions are used to isolate the use of processor resources between 64-bit media instructions and x87 floating-point instructions.

- **EMMS**—Exit Media State
- **FEMMS**—Fast Exit Media State

These instructions initialize the contents of the x87 floating-point stack registers—called *clearing the MMX state*. Software should execute one of these instructions before leaving a 64-bit media procedure.

The **EMMS** and **FEMMS** instructions both clear the MMX state, as described in “Mixing Media Code with x87 Code” on page 286. The instructions differ in one respect: **FEMMS** leaves

the data in the x87 stack registers undefined. By contrast, EMMS leaves the data in each such register as it was defined by the last x87 or 64-bit media instruction that wrote to the register. The FEMMS instruction is supported for backward-compatibility. Software that must be compatible with both AMD and non-AMD processors should use the EMMS instruction.

5.6.3 Data Transfer

The data-transfer instructions copy operands between a 32-bit or 64-bit memory location, an MMX register, an XMM register, or a GPR. The MOV mnemonic, which stands for *move*, is a misnomer. A copy function is actually performed instead of a move.

Move.

- MOVD—Move Doubleword
- MOVQ—Move Quadword
- MOVDQ2Q—Move Double Quadword to Quadword
- MOVQ2DQ—Move Quadword to Double Quadword

The MOVD instruction copies a 32-bit or 64-bit value from a general-purpose register (GPR) or memory location to an MMX register, or from an MMX register to a GPR or memory location. If the source operand is 32 bits and the destination operand is 64 bits, the source is zero-extended to 64 bits in the destination. If the source is 64 bits and the destination is 32 bits, only the low-order 32 bits of the source are copied to the destination.

The MOVQ instruction copies a 64-bit value from an MMX register or 64-bit memory location to another MMX register, or from an MMX register to another MMX register or 64-bit memory location.

The MOVDQ2Q instruction copies the low-order 64-bit value in an XMM register to an MMX register.

The MOVQ2DQ instruction copies a 64-bit value from an MMX register to the low-order 64 bits of an XMM register, with zero-extension to 128 bits.

The MOVD and MOVQ instructions—along with the PUNPCKx instructions—are often among the most frequently used instructions in 64-bit media procedures (both integer and floating-point). The move instructions are similar to the assignment operator in high-level languages.

Move Non-Temporal. The move non-temporal instructions are called *streaming-store* instructions. They minimize pollution of the cache. The assumption is that the data they reference will be used only once, and is therefore not subject to cache-related overhead such as write-allocation. For further information, see “Memory Optimization” on page 115.

- MOVNTQ—Move Non-Temporal Quadword
- MASKMOVQ—Mask Move Quadword

The MOVNTQ instruction stores a 64-bit MMX register value into a 64-bit memory location. The MASKMOVQ instruction stores bytes from the first operand, as selected by the mask value (most-significant bit of each byte) in the second operand, to a memory location specified in the rDI and DS registers. The first operand is an MMX register, and the second operand is another MMX register. The size of the store is determined by the effective address size. Figure 5-11 shows the MASKMOVQ operation.

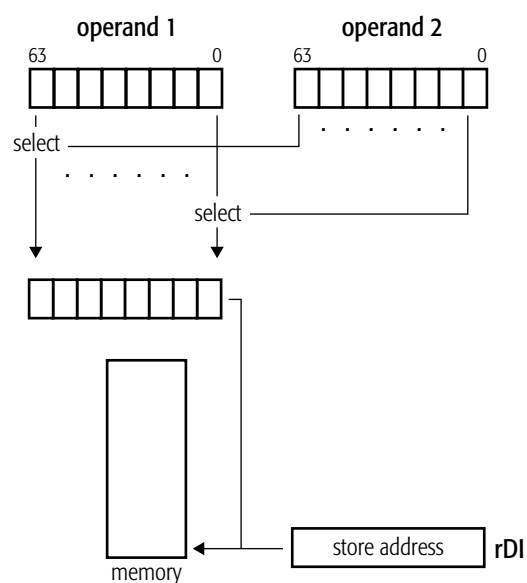

513-133.eps

Figure 5-11. MASKMOVQ Move Mask Operation

The MOVNTQ and MASKMOVQ instructions use weakly-ordered, write-combining buffering of write data, and they minimize cache pollution. The exact method by which cache

pollution is minimized depends on the hardware implementation of the instruction. For further information, see “Memory Optimization” on page 115.

A typical case benefitting from streaming stores occurs when data written by the processor is never read by the processor, such as data written to a graphics frame buffer. MASKMOVQ is useful for the handling of end cases in block copies and block fills based on streaming stores.

Move Mask.

- PMOVMSKB—Packed Move Mask Byte

The PMOVMSKB instruction moves the most-significant bit of each byte in an MMX register to the low-order byte of a 32-bit or 64-bit general-purpose register, with zero-extension. It is useful for extracting bits from a mask, or extracting zero-point values from quantized data such as signal samples, resulting in a byte that can be used for data-dependent branching.

5.6.4 **Data Conversion**

The integer data-conversion instructions convert operands from integer formats to floating-point formats. They take 64-bit integer source operands. For data-conversion instructions that take 32-bit and 64-bit floating-point source operands, see “Data Conversion” on page 274. For data-conversion instructions that take 128-bit source operands, see “Data Conversion” on page 171 and “Data Conversion” on page 197.

Convert Integer to Floating-Point. These instructions convert integer data types into floating-point data types.

- CVTPI2PS—Convert Packed Doubleword Integers to Packed Single-Precision Floating-Point
- CVTPI2PD—Convert Packed Doubleword Integers to Packed Double-Precision Floating-Point
- PI2FW—Packed Integer To Floating-Point Word Conversion
- PI2FD—Packed Integer to Floating-Point Doubleword Conversion

The CVTPI2Px instructions convert two 32-bit signed integer values in the second operand (an MMX register or 64-bit memory location) to two single-precision (CVTPI2PS) or double-precision (CVTPI2PD) floating-point values. The instructions then write the converted values into the low-order 64 bits of an XMM register (CVTPI2PS) or the full 128 bits of an

XMM register (CVTPI2PD). The CVTPI2PS instruction does not modify the high-order 64 bits of the XMM register.

The PI2Fx instructions are 3DNow! instructions. They convert two 16-bit (PI2FW) or 32-bit (PI2FD) signed integer values in the second operand to two single-precision floating-point values. The instructions then write the converted values into the destination. If a PI2FD conversion produces an inexact value, the value is truncated (rounded toward zero).

5.6.5 Data Reordering

The integer data-reordering instructions pack, unpack, interleave, extract, insert, shuffle, and swap the elements of vector operands.

Pack with Saturation. These instructions pack 2x-sized data types into 1x-sized data types, thus halving the precision of each element in a vector operand.

- PACKSSDW—Pack with Saturation Signed Doubleword to Word
- PACKSSWB—Pack with Saturation Signed Word to Byte
- PACKUSWB—Pack with Saturation Signed Word to Unsigned Byte

The PACKSSDW instruction converts each 32-bit signed integer in its two source operands (an MMX register or 64-bit memory location and another MMX register) into a 16-bit signed integer and packs the converted values into the destination MMX register. The PACKSSWB instruction does the analogous operation between word elements in the source vectors and byte elements in the destination vector. The PACKUSWB instruction does the same as PACKSSWB except that it converts word integers into unsigned (rather than signed) bytes.

Figure 5-12 on page 260 shows an example of a PACKSSDW instruction. The operation merges vector elements of 2x size (doubleword-size) into vector elements of 1x size (word-size), thus reducing the precision of the vector-element data types. Any results that would otherwise overflow or underflow are saturated (clamped) at the maximum or minimum representable value, respectively, as described in “Saturation” on page 250.

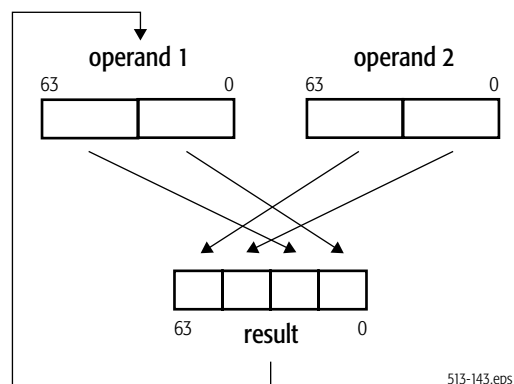

Figure 5-12. PACKSSDW Pack Operation

Conversion from higher-to-lower precision may be needed, for example, after an arithmetic operation which requires the higher-precision format to prevent possible overflow, but which requires the lower-precision format for a subsequent operation.

Unpack and Interleave. These instructions interleave vector elements from the high or low half of two source operands. They can be used to double the precision of operands.

- PUNPCKHBW—Unpack and Interleave High Bytes
- PUNPCKHWD—Unpack and Interleave High Words
- PUNPCKHDQ—Unpack and Interleave High Doublewords
- PUNPCKLBW—Unpack and Interleave Low Bytes
- PUNPCKLWD—Unpack and Interleave Low Words
- PUNPCKLDQ—Unpack and Interleave Low Doublewords

The PUNPCKHBW instruction unpacks the four high-order bytes from its two source operands and interleaves them into the bytes in the destination operand. The bytes in the low-order half of the source operand are ignored. The PUNPCKHWD and PUNPCKHDQ instructions perform analogous operations for words and doublewords in the source operands, packing them into interleaved words and interleaved doublewords in the destination operand.

The PUNPCKLBW, PUNPCKLWD, and PUNPCKLDQ instructions are analogous to their high-element counterparts

except that they take elements from the low doubleword of each source vector and ignore elements in the high doubleword. If the source operand for PUNPCKLx instructions is in memory, only the low 32 bits of the operand are loaded.

Figure 5-13 shows an example of the PUNPCKLWD instruction. The elements are taken from the low half of the source operands. In this register image, elements from *operand2* are placed to the left of elements from *operand1*.

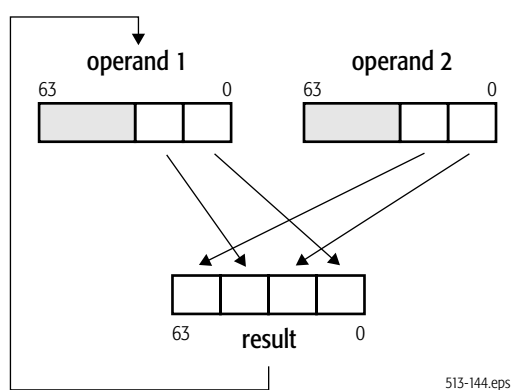

Figure 5-13. PUNPCKLWD Unpack and Interleave Operation

If one of the two source operands is a vector consisting of all zero-valued elements, the unpack instructions perform the function of expanding vector elements of 1x size into vector elements of 2x size (for example, word-size to doubleword-size). If both source operands are of identical value, the unpack instructions can perform the function of duplicating adjacent elements in a vector.

The PUNPCKx instructions—along with MOVD and MOVQ—are among the most frequently used instructions in 64-bit media procedures (both integer and floating-point).

Extract and Insert. These instructions copy a word element from a vector, in a manner specified by an immediate operand.

- PEXTRW—Packed Extract Word
- PINSRW—Packed Insert Word

The PEXTRW instruction extracts a 16-bit value from an MMX register, as selected by the immediate-byte operand, and writes it to the low-order word of a 32-bit or 64-bit general-purpose register, with zero-extension to 32 or 64 bits. PEXTRW is useful for loading computed values, such as table-lookup indices, into general-purpose registers where the values can be used for addressing tables in memory.

The PINSRW instruction inserts a 16-bit value from a the low-order word of a 32-bit or 64-bit general purpose register or a 16-bit memory location into an MMX register. The location in the destination register is selected by the immediate-byte operand. The other words in the destination register operand are not modified.

Shuffle and Swap. These instructions reorder the elements of a vector.

- PSHUFW—Packed Shuffle Words
- PSWAPD—Packed Swap Doubleword

The PSHUFW instruction moves any one of the four words in its second operand (an MMX register or 64-bit memory location) to specified word locations in its first operand (another MMX register). The ordering of the shuffle can occur in any of 256 possible ways, as specified by the immediate-byte operand. Figure 5-14 shows one of the 256 possible shuffle operations. PSHUFW is useful, for example, in color imaging when computing alpha saturation of RGB values. In this case, PSHUFW can replicate an alpha value in a register so that parallel comparisons with three RGB values can be performed.

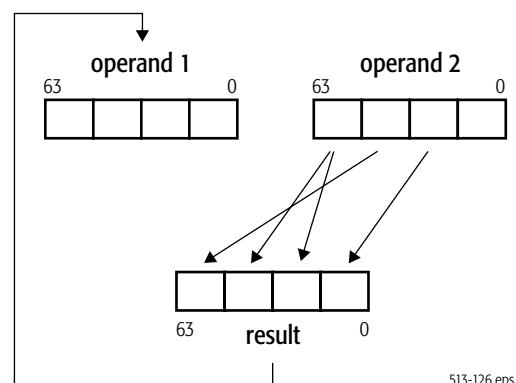

Figure 5-14. PSHUFW Shuffle Operation

The PSWAPD instruction swaps (reverses) the order of two 32-bit values in the second operand and writes each swapped value in the corresponding doubleword of the destination. Figure 5-15 shows a swap operation. PSWAPD is useful, for example, in complex-number multiplication in which the elements of one source operand must be swapped (see “Accumulation” on page 276 for details). PSWAPD supports independent source and result operands so that it can also perform a load function.

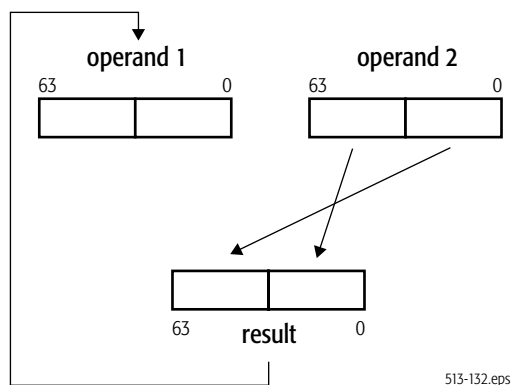

Figure 5-15. PSWAPD Swap Operation

5.6.6 Arithmetic

The integer vector-arithmetic instructions perform an arithmetic operation on the elements of two source vectors. Arithmetic instructions that are not specifically named as unsigned perform signed two’s-complement arithmetic.

Addition.

- PADDDB—Packed Add Bytes
- PADDW—Packed Add Words
- PADDD—Packed Add Doublewords
- PADDQ—Packed Add Quadwords
- PADDSB—Packed Add with Saturation Bytes
- PADDSW—Packed Add with Saturation Words
- PADDUSB—Packed Add Unsigned with Saturation Bytes
- PADDUSW—Packed Add Unsigned with Saturation Words

The PADDDB, PADDW, PADDD, and PADDQ instructions add each 8-bit (PADDDB), 16-bit (PADDW), 32-bit (PADDD), or 64-bit (PADDQ) integer element in the second operand to the

corresponding, same-sized integer element in the first operand. The instructions then write the integer result of each addition to the corresponding, same-sized element of the destination. These instructions operate on both signed and unsigned integers. However, if the result overflows, only the low-order byte, word, doubleword, or quadword of each result is written to the destination. The PADD instruction can be used together with PMADDWD (page 266) to implement dot products.

The PADD SB and PADD SW instructions perform additions analogous to the PADD B and PADD W instructions, except with saturation. For each result in the destination, if the result is larger than the largest, or smaller than the smallest, representable 8-bit (PADD SB) or 16-bit (PADD SW) signed integer, the result is saturated to the largest or smallest representable value, respectively.

The PADD USB and PADD USW instructions perform saturating additions analogous to the PADD SB and PADD SW instructions, except on unsigned integer elements.

Subtraction.

- PSUBB—Packed Subtract Bytes
- PSUBW—Packed Subtract Words
- PSUBD—Packed Subtract Doublewords
- PSUBQ—Packed Subtract Quadword
- PSUB SB—Packed Subtract with Saturation Bytes
- PSUB SW—Packed Subtract with Saturation Words
- PSUB USB—Packed Subtract Unsigned and Saturate Bytes
- PSUB USW—Packed Subtract Unsigned and Saturate Words

The subtraction instructions perform operations analogous to the addition instructions.

The PSUB B, PSUB W, PSUB D, and PSUB Q instructions subtract each 8-bit (PSUB B), 16-bit (PSUB W), 32-bit (PSUB D), or 64-bit (PSUB Q) integer element in the second operand from the corresponding, same-sized integer element in the first operand. The instructions then write the integer result of each subtraction to the corresponding, same-sized element of the destination. These instructions operate on both signed and unsigned integers. However, if the result underflows, only the

low-order byte, word, doubleword, or quadword of each result is written to the destination.

The PSUBSB and PSUBSW instructions perform subtractions analogous to the PSUBB and PSUBW instructions, except with saturation. For each result in the destination, if the result is larger than the largest, or smaller than the smallest, representable 8-bit (PSUBSB) or 16-bit (PSUBSW) signed integer, the result is saturated to the largest or smallest representable value, respectively.

The PSUBUSB and PSUBUSW instructions perform saturating subtractions analogous to the PSUBSB and PSUBSW instructions, except on unsigned integer elements.

Multiplication.

- PMULHW—Packed Multiply High Signed Word
- PMULLW—Packed Multiply Low Signed Word
- PMULHRW—Packed Multiply High Rounded Word
- PMULHUW—Packed Multiply High Unsigned Word
- PMULUDQ—Packed Multiply Unsigned Doubleword and Store Quadword

The PMULHW instruction multiplies each 16-bit signed integer value in first operand by the corresponding 16-bit integer in the second operand, producing a 32-bit intermediate result. The instruction then writes the high-order 16 bits of the 32-bit intermediate result of each multiplication to the corresponding word of the destination. The PMULLW instruction performs the same multiplication as PMULHW but writes the low-order 16 bits of the 32-bit intermediate result to the corresponding word of the destination.

The PMULHRW instruction performs the same multiplication as PMULHW but with rounding. After the multiplication, PMULHRW adds 8000h to the lower word of the doubleword result, thus rounding the high-order word which is returned as the result.

The PMULHUW instruction performs the same multiplication as PMULHW but on unsigned operands. The instruction is useful in 3D rasterization, which operates on unsigned pixel values.

The PMULUDQ instruction, unlike the other PMUL x instructions, preserves the full precision of the result. It multiplies 32-bit unsigned integer values in the first and second operands and writes the full 64-bit result to the destination.

See “Shift” on page 268 for shift instructions that can be used to perform multiplication and division by powers of 2.

Multiply-Add.

■ PMADDWD—Packed Multiply Words and Add Doublewords

The PMADDWD instruction multiplies each 16-bit signed value in the first operand by the corresponding 16-bit signed value in the second operand. The instruction then adds the adjacent 32-bit intermediate results of each multiplication, and writes the 32-bit result of each addition into the corresponding doubleword of the destination. PMADDWD thus performs two signed $(16 \times 16 = 32) + (16 \times 16 = 32)$ multiply-adds in parallel. Figure 5-16 on page 267 shows the PMADDWD operation.

The only case in which overflow can occur is when all four of the 16-bit source operands used to produce a 32-bit multiply-add result have the value 8000h. In this case, the result returned is 8000_0000h, because the maximum negative 16-bit value of 8000h multiplied by itself equals 4000_0000h, and 4000_0000h added to 4000_0000h equals 8000_0000h. The result of multiplying two negative numbers should be a positive number, but 8000_0000h is the maximum possible 32-bit negative number rather than a positive number.

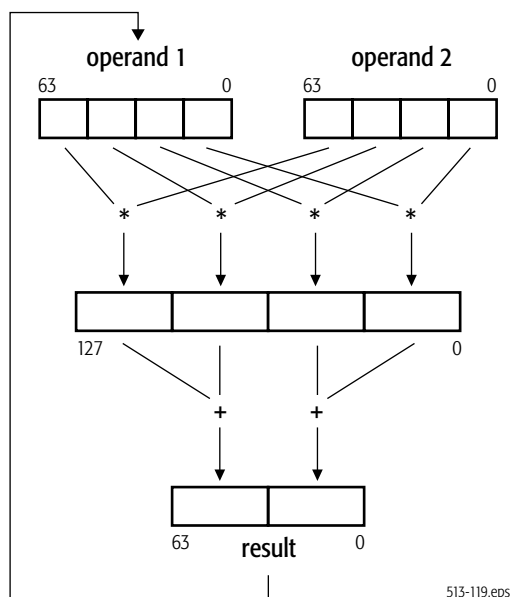

Figure 5-16. PMADDWD Multiply-Add Operation

PMADDWD can be used with one source operand (for example, a coefficient) taken from memory and the other source operand (for example, the data to be multiplied by that coefficient) taken from an MMX register. The instruction can also be used together with the PADDD instruction (page 263) to compute dot products, such as those required for finite impulse response (FIR) filters, one of the commonly used DSP algorithms. Scaling can be done, before or after the multiply, using a vector-shift instruction (page 268).

For floating-point multiplication operations, see the PFMUL instruction on page 276. For floating-point accumulation operations, see the PFACC, PFNACC, and PFPNACC instructions on page 276.

Average.

- PAVGB—Packed Average Unsigned Bytes
- PAVGW—Packed Average Unsigned Words
- PAVGUSB—Packed Average Unsigned Packed Bytes

The PAVGx instructions compute the rounded average of each unsigned 8-bit (PAVGB) or 16-bit (PAVGW) integer value in the

first operand and the corresponding, same-sized unsigned integer in the second operand. The instructions then write each average in the corresponding, same-sized element of the destination. The rounded average is computed by adding each pair of operands, adding 1 to the temporary sum, and then right-shifting the temporary sum by one bit.

The PAVGB instruction is useful for MPEG decoding, in which motion compensation performs many byte-averaging operations between and within macroblocks. In addition to speeding up these operations, PAVGB can free up registers and make it possible to unroll the averaging loops.

The PAVGUSB instruction (a 3DNow! instruction) performs a function identical to the PAVGB instruction, described on page 267, although the two instructions have different opcodes.

Sum of Absolute Differences.

- PSADBW—Packed Sum of Absolute Differences of Bytes into a Word

The PSADBW instruction computes the absolute values of the differences of corresponding 8-bit signed integer values in the first and second operands. The instruction then sums the differences and writes an unsigned 16-bit integer result in the low-order word of the destination. The remaining bytes in the destination are cleared to all 0s.

Sums of absolute differences are used to compute the L1 norm in motion-estimation algorithms for video compression.

5.6.7 **Shift**

The vector-shift instructions are useful for scaling vector elements to higher or lower precision, packing and unpacking vector elements, and multiplying and dividing vector elements by powers of 2.

Left Logical Shift.

- PSLW—Packed Shift Left Logical Words
- PSLD—Packed Shift Left Logical Doublewords
- PSLQ—Packed Shift Left Logical Quadwords

The PSLx instructions left-shift each of the 16-bit (PSLW), 32-bit (PSLD), or 64-bit (PSLQ) values in the first operand by the number of bits specified in the second operand. The instructions then write each shifted value into the

corresponding, same-sized element of the destination. The first and second operands are either an MMX register and another MMX register or 64-bit memory location, or an MMX register and an immediate-byte value. The low-order bits that are emptied by the shift operation are cleared to 0.

In integer arithmetic, left logical shifts effectively multiply unsigned operands by positive powers of 2.

Right Logical Shift.

- PSRLW—Packed Shift Right Logical Words
- PSRLD—Packed Shift Right Logical Doublewords
- PSRLQ—Packed Shift Right Logical Quadwords

The PSRLx instructions right-shift each of the 16-bit (PSRLW), 32-bit (PSRLD), or 64-bit (PSRLQ) values in the first operand by the number of bits specified in the second operand. The instructions then write each shifted value into the corresponding, same-sized element of the destination. The first and second operands are either an MMX register and another MMX register or 64-bit memory location, or an MMX register and an immediate-byte value. The high-order bits that are emptied by the shift operation are cleared to 0. In integer arithmetic, right logical shifts effectively divide unsigned operands or positive signed operands by positive powers of 2.

PSRLQ can be used to move the high 32 bits of an MMX register to the low 32 bits of the register.

Right Arithmetic Shift.

- PSRAW—Packed Shift Right Arithmetic Words
- PSRAD—Packed Shift Right Arithmetic Doublewords

The PSRAx instructions right-shifts each of the 16-bit (PSRAW) or 32-bit (PSRAD) values in the first operand by the number of bits specified in the second operand. The instructions then write each shifted value into the corresponding, same-sized element of the destination. The high-order bits that are emptied by the shift operation are filled with the sign bit of the initial value.

In integer arithmetic, right arithmetic shifts effectively divide signed operands by positive powers of 2.

5.6.8 Compare

The integer vector-compare instructions compare two operands, and they either write a mask or they write the maximum or minimum value.

Compare and Write Mask.

- PCMPEQB—Packed Compare Equal Bytes
- PCMPEQW—Packed Compare Equal Words
- PCMPEQD—Packed Compare Equal Doublewords
- PCMPGTB—Packed Compare Greater Than Signed Bytes
- PCMPGTW—Packed Compare Greater Than Signed Words
- PCMPGTD—Packed Compare Greater Than Signed Doublewords

The PCMPEQx and PCMPGTx instructions compare corresponding bytes, words, or doubleword in the first and second operands. The instructions then write a mask of all 1s or 0s for each compare into the corresponding, same-sized element of the destination.

For the PCMPEQx instructions, if the compared values are equal, the result mask is all 1s. If the values are not equal, the result mask is all 0s. For the PCMPGTx instructions, if the signed value in the first operand is greater than the signed value in the second operand, the result mask is all 1s. If the value in the first operand is less than or equal to the value in the second operand, the result mask is all 0s. PCMPEQx can be used to set the bits in an MMX register to all 1s by specifying the same register for both operands.

By specifying the same register for both operands, PCMPEQx can be used to set the bits in an MMX register to all 1s.

Figure 5-5 on page 243 shows an example of a non-branching sequence that implements a two-way multiplexer—one that is equivalent to the following sequence of ternary operators in C or C++:

```
r0 = a0 > b0 ? a0 : b0
r1 = a1 > b1 ? a1 : b1
r2 = a2 > b2 ? a2 : b2
r3 = a3 > b3 ? a3 : b3
```

Assuming mmx0 contains a, and mmx1 contains b, the above C sequence can be implemented with the following assembler sequence:

```

MOVQ      mmx3, mmx0
PCMPGTW   mmx3, mmx2 ; a > b ? 0xffff : 0
PAND      mmx0, mmx3 ; a > b ? a : 0
PANDN     mmx3, mmx1 ; a > b > 0 : b
POR       mmx0, mmx3 ; r = a > b ? a : b

```

In the above sequence, PCMPGTW, PAND, PANDN, and POR operate, in parallel, on all four elements of the vectors.

Compare and Write Minimum or Maximum.

- PMAXUB—Packed Maximum Unsigned Bytes
- PMINUB—Packed Minimum Unsigned Bytes
- PMAXSW—Packed Maximum Signed Words
- PMINSW—Packed Minimum Signed Words

The PMAXUB and PMINUB instructions compare each of the 8-bit unsigned integer values in the first operand with the corresponding 8-bit unsigned integer values in the second operand. The instructions then write the maximum (PMAXUB) or minimum (PMINUB) of the two values for each comparison into the corresponding byte of the destination.

The PMAXSW and PMINSW instructions perform operations analogous to the PMAXUB and PMINUB instructions, except on 16-bit signed integer values.

5.6.9 Logical

The vector-logic instructions perform Boolean logic operations, including AND, OR, and exclusive OR.

And.

- PAND—Packed Logical Bitwise AND
- PANDN—Packed Logical Bitwise AND NOT

The PAND instruction performs a bitwise logical AND of the values in the first and second operands and writes the result to the destination.

The PANDN instruction inverts the first operand (creating a one's complement of the operand), ANDs it with the second operand, and writes the result to the destination, and writes the result to the destination. Table 5-5 on page 272 shows an example.

Table 5-5. Example PANDN Bit Values

Operand1 Bit	Operand1 Bit (Inverted)	Operand2 Bit	PANDN Result Bit
1	0	1	0
1	0	0	0
0	1	1	1
0	1	0	0

PAND can be used with the value `7FFFFFFF7FFFFFFFh` to compute the absolute value of the elements of a 64-bit media floating-point vector operand. This method is equivalent to the x87 FABS (floating-point absolute value) instruction.

Or.

- POR—Packed Logical Bitwise OR

The POR instruction performs a bitwise logical OR of the values in the first and second operands and writes the result to the destination.

Exclusive Or.

- PXOR—Packed Logical Bitwise Exclusive OR

The PXOR instruction performs a bitwise logical exclusive OR of the values in the first and second operands and writes the result to the destination. PXOR can be used to clear all bits in an MMX register by specifying the same register for both operands. PXOR can also be used with the value `8000000080000000h` to change the sign bits of the elements of a 64-bit media floating-point vector operand. This method is equivalent to the x87 floating-point change sign (FCHS) instruction.

5.6.10 Save and Restore State

These instructions save and restore the processor state for 64-bit media instructions.

Save and Restore 64-Bit Media and x87 State.

- FSAVE—Save x87 and MMX State
- FNSAVE—Save No-Wait x87 and MMX State

- **FRSTOR—Restore x87 and MMX State**

These instructions save and restore the entire processor state for x87 floating-point instructions and 64-bit media instructions. The instructions save and restore either 94 or 108 bytes of data, depending on the effective operand size.

Assemblers issue `FSAVE` as an `FWAIT` instruction followed by an `FNSAVE` instruction. Thus, `FSAVE` (but not `FNSAVE`) reports pending unmasked x87 floating-point exceptions before saving the state. After saving the state, the processor initializes the x87 state by performing the equivalent of an `FINIT` instruction.

Save and Restore 128-Bit, 64-Bit, and x87 State.

- **FXSAVE—Save XMM, MMX, and x87 State**
- **FXRSTOR—Restore XMM, MMX, and x87 State**

The `FXSAVE` and `FXRSTOR` instructions save and restore the entire 512-byte processor state for 128-bit media instructions, 64-bit media instructions, and x87 floating-point instructions. The architecture supports two memory formats for `FXSAVE` and `FXRSTOR`, a 512-byte 32-bit legacy format and a 512-byte 64-bit format. Selection of the 32-bit or 64-bit format is determined by the effective operand size for the `FXSAVE` and `FXRSTOR` instructions. For details, see “Saving Media and x87 Processor State” in Volume 2.

`FXSAVE` and `FXRSTOR` execute faster than `FSAVE/FNSAVE` and `FRSTOR`. However, unlike `FSAVE` and `FNSAVE`, `FXSAVE` does not initialize the x87 state, and like `FNSAVE` it does not report pending unmasked x87 floating-point exceptions. For details, see “Saving and Restoring State” on page 287.

5.7 Instruction Summary—Floating-Point Instructions

This section summarizes the functions of the floating-point (3DNow! and a few SSE and SSE2) instructions in the 64-bit media instruction subset. These include floating-point instructions that use an MMX register for source or destination and data-conversion instructions that convert from floating-point to integers formats. For a summary of the integer instructions in the 64-bit media instruction subset, including data-conversion instructions that convert from integer to

floating-point formats, see “Instruction Summary—Integer Instructions” on page 253.

For a summary of the 128-bit media floating-point instructions, see “Instruction Summary—Floating-Point Instructions” on page 192. For a summary of the x87 floating-point instructions, see “Instruction Summary” on page 323.

The instructions are organized here by functional group—such as data-transfer, vector arithmetic, and so on. Software running at any privilege level can use any of these instructions, if the CPUID instruction reports support for the instructions (see “Feature Detection” on page 281). More detail on individual instructions is given in the alphabetically organized “64-Bit Media Instruction Reference” in Volume 5.

5.7.1 Syntax

The 64-bit media floating-point instructions have the same syntax rules as those for the 64-bit media integer instructions, described in “Syntax” on page 254, except that the mnemonics of most floating-point instructions begin with the following prefix:

- **PF**—Packed floating-point

5.7.2 Data Conversion

These data-conversion instructions convert operands from floating-point to integer formats. The instructions take 32-bit or 64-bit floating-point source operands. For data-conversion instructions that take 64-bit integer source operands, see “Data Conversion” on page 258. For data-conversion instructions that take 128-bit source operands, see “Data Conversion” on page 171 and “Data Conversion” on page 197.

Convert Floating-Point to Integer.

- **CVTTPS2PI**—Convert Packed Single-Precision Floating-Point to Packed Doubleword Integers
- **CVTTTPS2PI**—Convert Packed Single-Precision Floating-Point to Packed Doubleword Integers, Truncated
- **CVTPD2PI**—Convert Packed Double-Precision Floating-Point to Packed Doubleword Integers
- **CVTTDP2PI**—Convert Packed Double-Precision Floating-Point to Packed Doubleword Integers, Truncated
- **PF2IW**—Packed Floating-Point to Integer Word Conversion
- **PF2ID**—Packed Floating-Point to Integer Doubleword Conversion

The CVTTPS2PI and CVTTPS2PI instructions convert two single-precision (32-bit) floating-point values in the second operand (the low-order 64 bits of an XMM register or a 64-bit memory location) to two 32-bit signed integers, and write the converted values into the first operand (an MMX register). For the CVTTPS2PI instruction, if the conversion result is an inexact value, the value is rounded as specified in the rounding control (RC) field of the MXCSR register (“MXCSR Register” on page 144), but for the CVTTPS2PI instruction such a result is truncated (rounded toward zero).

The CVTTPD2PI and CVTTPD2PI instructions perform conversions analogous to CVTTPS2PI and CVTTPS2PI but for two double-precision (64-bit) floating-point values.

The 3DNow! PF2IW instruction converts two single-precision floating-point values in the second operand (an MMX register or a 64-bit memory location) to two 16-bit signed integer values, sign-extended to 32-bits, and writes the converted values into the first operand (an MMX register). The 3DNow! PF2ID instruction converts two single-precision floating-point values in the second operand to two 32-bit signed integer values, and writes the converted values into the first operand. If the result of either conversion is an inexact value, the value is truncated (rounded toward zero).

As described in “Floating-Point Data Types” on page 251, PF2IW and PF2ID do not fully comply with the IEEE-754 standard. Conversion of some source operands of the C type *float* (IEEE-754 single-precision)—specifically NaNs, infinities, and denormals—are not supported. Attempts to convert such source operands produce undefined results, and no exceptions are generated.

5.7.3 Arithmetic

The floating-point vector-arithmetic instructions perform an arithmetic operation on two floating-point operands. For a description of 3DNow! instruction saturation on overflow and underflow conditions, see “Floating-Point Data Types” on page 251.

Addition.

- PFADD—Packed Floating-Point Add

The PFADD instruction adds each single-precision floating-point value in the first operand (an MMX register) to the

corresponding single-precision floating-point value in the second operand (an MMX register or 64-bit memory location). The instruction then writes the result of each addition into the corresponding doubleword of the destination.

Subtraction.

- PFSUB—Packed Floating-Point Subtract
- PFSUBR—Packed Floating-Point Subtract Reverse

The PFSUB instruction subtracts each single-precision floating-point value in the second operand from the corresponding single-precision floating-point value in the first operand. The instruction then writes the result of each subtraction into the corresponding quadword of the destination.

The PFSUBR instruction performs a subtraction that is the reverse of the PFSUB instruction. It subtracts each value in the first operand from the corresponding value in the second operand. The provision of both the PFSUB and PFSUBR instructions allows software to choose which source operand to overwrite during a subtraction.

Multiplication.

- PFMUL—Packed Floating-Point Multiply

The PFMUL instruction multiplies each of the two single-precision floating-point values in the first operand by the corresponding single-precision floating-point value in the second operand and writes the result of each multiplication into the corresponding doubleword of the destination.

Division.

For a description of floating-point division techniques, see “Reciprocal Estimation” on page 278. Division is equivalent to multiplication of the dividend by the reciprocal of the divisor.

Accumulation.

- PFACC—Packed Floating-Point Accumulate
- PFNACC—Packed Floating-Point Negative Accumulate
- PFPNACC—Packed Floating-Point Positive-Negative Accumulate

The PFACC instruction adds the two single-precision floating-point values in the first operand and writes the result into the low-order word of the destination, and it adds the two single-precision values in the second operand and writes the result into the high-order word of the destination. Figure 5-17 illustrates the operation.

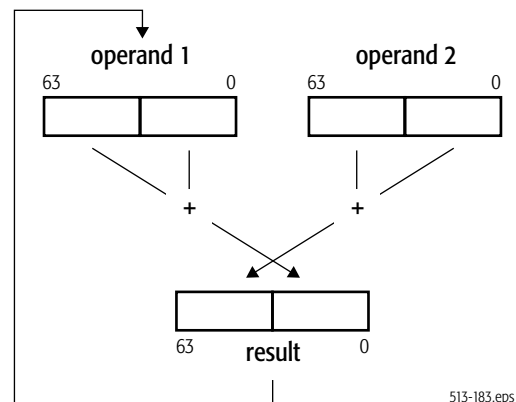

Figure 5-17. PFACC Accumulate Operation

The PFNACC instruction subtracts the first operand's high-order single-precision floating-point value from its low-order single-precision floating-point value and writes the result into the low-order doubleword of the destination, and it subtracts the second operand's high-order single-precision floating-point value from its low-order single-precision floating-point value and writes the result into the high-order doubleword of the destination.

The PFPNACC instruction *subtracts* the first operand's high-order single-precision floating-point value from its low-order single-precision floating-point value and writes the result into the low-order doubleword of the destination, and it *adds* the two single-precision values in the second operand and writes the result into the high-order doubleword of the destination.

PFPNACC is useful in complex-number multiplication, in which mixed positive-negative accumulation must be performed. Assuming that complex numbers are represented as two-element vectors (one element is the real part, the other element is the imaginary part), there is a need to swap the elements of

one source operand to perform the multiplication, and there is a need for mixed positive-negative accumulation to complete the parallel computation of real and imaginary results. The PSWAPD instruction can swap elements of one source operand and the PFPNACC instruction can perform the mixed positive-negative accumulation to complete the computation.

Reciprocal Estimation.

- PFRCP—Packed Floating-Point Reciprocal Approximation
- PFRCPIT1—Packed Floating-Point Reciprocal, Iteration 1
- PFRCPIT2—Packed Floating-Point Reciprocal or Reciprocal Square Root, Iteration 2

The PFRCP instruction computes the approximate reciprocal of the single-precision floating-point value in the low-order 32 bits of the second operand and writes the result into both doublewords of the first operand.

The PFRCPIT1 instruction performs the first intermediate step in the Newton-Raphson iteration to refine the reciprocal approximation produced by the PFRCP instruction. The first operand contains the input to a previous PFRCP instruction, and the second operand contains the result of the same PFRCP instruction.

The PFRCPIT2 instruction performs the second and final step in the Newton-Raphson iteration to refine the reciprocal approximation produced by the PFRCP instruction or the reciprocal square-root approximation produced by the PFSQRT instructions. The first operand contains the result of a previous PFRCPIT1 or PFRSQIT1 instruction, and the second operand contains the result of a PFRCP or PFRSQRT instruction.

The PFRCP instruction can be used together with the PFRCPIT1 and PFRCPIT2 instructions to increase the accuracy of a single-precision significand.

Reciprocal Square Root.

- PFRSQRT—Packed Floating-Point Reciprocal Square Root Approximation
- PFRSQIT1—Packed Floating-Point Reciprocal Square Root, Iteration 1

The PFRSQRT instruction computes the approximate reciprocal square root of the single-precision floating-point value in the low-order 32 bits of the second operand and writes the result into each doubleword of the first operand. The second operand is a single-precision floating-point value with a 24-bit significand. The result written to the first operand is accurate to 15 bits. Negative operands are treated as positive operands for purposes of reciprocal square-root computation, with the sign of the result the same as the sign of the source operand.

The PFRSQIT1 instruction performs the first step in the Newton-Raphson iteration to refine the reciprocal square-root approximation produced by the PFSQRT instruction. The first operand contains the input to a previous PFRSQRT instruction, and the second operand contains the square of the result of the same PFRSQRT instruction.

The PFRSQRT instruction can be used together with the PFRSQIT1 instruction and the PFRCPIT2 instruction (described in “Reciprocal Estimation” on page 278) to increase the accuracy of a single-precision significand.

5.7.4 Compare

The floating-point vector-compare instructions compare two operands, and they either write a mask or they write the maximum or minimum value.

Compare and Write Mask.

- PFCMPEQ—Packed Floating-Point Compare Equal
- PFCMPGT—Packed Floating-Point Compare Greater Than
- PFCMPGE—Packed Floating-Point Compare Greater or Equal

The PFCMP x instructions compare each of the two single-precision floating-point values in the first operand with the corresponding single-precision floating-point value in the second operand. The instructions then write the result of each comparison into the corresponding doubleword of the destination. If the comparison test (equal, greater than, greater or equal) is true, the result is a mask of all 1s. If the comparison test is false, the result is a mask of all 0s.

Compare and Write Minimum or Maximum.

- PFMAX—Packed Floating-Point Maximum
- PFMIN—Packed Floating-Point Minimum

The PFMAX and PFMIN instructions compare each of the two single-precision floating-point values in the first operand with the corresponding single-precision floating-point value in the second operand. The instructions then write the maximum (PFMAX) or minimum (PFMIN) of the two values for each comparison into the corresponding doubleword of the destination.

The PFMIN and PFMAX instructions are useful for clamping, such as color clamping in 3D geometry and rasterization. They can also be used to avoid branching.

5.8 Instruction Effects on Flags

The 64-bit media instructions do not read or write any flags in the rFLAGS register, nor do they write any exception-status flags in the x87 status-word register, nor is their execution dependent on any mask bits in the x87 control-word register. The only x87 state affected by the 64-bit media instructions is described in “Actions Taken on Executing 64-Bit Media Instructions” on page 284.

5.9 Instruction Prefixes

Instruction prefixes, in general, are described in “Instruction Prefixes” on page 87. The following restrictions apply to the use of instruction prefixes with 64-bit media instructions.

5.9.1 Supported Prefixes

The following prefixes can be used with 64-bit media instructions:

- *Address-Size Override*—The 67h prefix affects only operands in memory. The prefix is ignored by all other 64-bit media instructions.
- *Operand-Size Override*—The 66h prefix is used to form the opcodes of certain 64-bit media instructions. The prefix is ignored by all other 64-bit media instructions.
- *Segment Overrides*—The 2Eh (CS), 36h (SS), 3Eh (DS), 26h (ES), 64h (FS), and 65h (GS) prefixes affect only operands in memory. In 64-bit mode, the contents of the CS, DS, ES, SS segment registers are ignored.
- *REP*—The F2 and F3h prefixes do not function as repeat prefixes for 64-bit media instructions. Instead, they are used

to form the opcodes of certain 64-bit media instructions. The prefixes are ignored by all other 64-bit media instructions.

- *REX*—The REX prefixes affect operands that reference a GPR or XMM register when running in 64-bit mode. It allows access to the full 64-bit width of any of the 16 extended GPRs and to any of the 16 extended XMM registers. The REX prefix also affects the FXSAVE and FXRSTOR instructions, in which it selects between two types of 512-byte memory-image format, as described in “Saving Media and x87 Processor State” in Volume 2. The prefix is ignored by all other 64-bit media instructions.

5.9.2 Special-Use and Reserved Prefixes

The following prefixes are used as opcode bytes in some 64-bit media instructions and are reserved in all other 64-bit media instructions:

- *Operand-Size Override*—The 66h prefix.
- *REP*—The F2 and F3h prefixes.

5.9.3 Prefixes That Cause Exceptions

The following prefixes cause an exception:

- *LOCK*—The F0h prefix causes an invalid-opcode exception when used with 64-bit media instructions.

5.10 Feature Detection

Before executing 64-bit media instructions, software should determine whether the processor supports the technology by executing the CUID instruction. “Feature Detection” on page 92 describes how software uses the CUID instruction to detect feature support. For full support of the 64-bit media instructions documented here, the following features require detection:

- MMX instructions, indicated by bit 23 of CUID standard function 1 and extended function 8000_0001h.
- 3DNow! instructions, indicated by bit 31 of CUID extended function 8000_0001h.
- MMX extensions, indicated by bit 22 of CUID extended function 8000_0001h.
- 3DNow! extensions, indicated by bit 30 of CUID extended function 8000_0001h.
- SSE instructions, indicated by bit 25 of CUID extended function 8000_0001h.

- SSE2 instruction extensions, indicated by bit 26 of CPUID extended function 8000_0001h.

Software may also wish to check for the following support, because the FXSAVE and FXRSTOR instructions execute faster than FSAVE and FRSTOR:

- FXSAVE and FXRSTOR, indicated by bit 24 of CPUID standard function 1 and extended function 8000_0001h.

Software that runs in long mode should also check for the following support:

- Long Mode, indicated by bit 29 of CPUID extended function 8000_0001h.

See “Processor Feature Identification” in Volume 2 for a full description of the CPUID instruction and its function codes.

If the FXSAVE and FXRSTOR instructions are to be used, the operating system must support these instructions by having set CR4.OSFXSR = 1. If the MMX floating-point-to-integer data-conversion instructions (CVTTPS2PI, CVTTPS2PI, CVTPD2PI, or CVTTPD2PI) are used, the operating system must support the FXSAVE and FXRSTOR instructions and SIMD floating-point exceptions (by having set CR4.OSXMMEXCPT = 1). For details, see “System-Control Registers” in Volume 2.

5.11 Exceptions

64-bit media instructions can generate two types of exceptions:

- *General-Purpose Exceptions*, described below in “General-Purpose Exceptions”
- *x87 Floating-Point Exceptions (#MF)*, described in “x87 Floating-Point Exceptions (#MF)” on page 284

All exceptions that occur while executing 64-bit media instructions can be handled by legacy exception handlers used for general-purpose instructions and x87 floating-point instructions.

5.11.1 General-Purpose Exceptions

The sections below list exceptions generated and not generated by general-purpose instructions. For a summary of the general-purpose exception mechanism, see “Interrupts and Exceptions” on page 106. For details about each exception and

its potential causes, see “Exceptions and Interrupts” in Volume 2.

Exceptions Generated. The 64-bit media instructions can generate the following general-purpose exceptions:

- #DB—Debug Exception (Vector 1)
- #UD—Invalid-Opcode Exception (Vector 6)
- #DF—Double-Fault Exception (Vector 8)
- #SS—Stack Exception (Vector 12)
- #GP—General-Protection Exception (Vector 13)
- #PF—Page-Fault Exception (Vector 14)
- #MF—x87 Floating-Point Exception-Pending (Vector 16)
- #AC—Alignment-Check Exception (Vector 17)
- #MC—Machine-Check Exception (Vector 18)
- #XF—SIMD Floating-Point Exception (Vector 19)—Only by the CVTTPS2PI, CVTTPS2PI, CVTPD2PI, and CVTTPD2PI instructions.

An invalid-opcode exception (#UD) can occur if a required CPUID feature flag is not set (see “Feature Detection” on page 281), or if an attempt is made to execute a 64-bit media instruction and the operating system has set the floating-point software-emulation (EM) bit in control register 0 to 1 (CR0.EM = 1).

For details on the system control-register bits, see “System-Control Registers” in Volume 2. For details on the machine-check mechanism, see “Machine Check Mechanism” in Volume 2.

For details on #MF exceptions, see “x87 Floating-Point Exceptions (#MF)” on page 284.

Exceptions Not Generated. The 64-bit media instructions do not generate the following general-purpose exceptions:

- #DE—Divide-By-Zero-Error Exception (Vector 0)
- Non-Maskable-Interrupt Exception (Vector 2)
- #BP—Breakpoint Exception (Vector 3)
- #OF—Overflow Exception (Vector 4)
- #BR—Bound-Range Exception (Vector 5)
- #NM—Device-Not-Available Exception (Vector 7)

- Coprocessor-Segment-Overrun Exception (Vector 9)
- #TS—Invalid-TSS Exception (Vector 10)
- #NP—Segment-Not-Present Exception (Vector 11)

For details on all general-purpose exceptions, see “Exceptions and Interrupts” in Volume 2.

5.11.2 x87 Floating-Point Exceptions (#MF)

The 64-bit media instructions do not generate x87 floating-point (#MF) exceptions as a consequence of their own computations. However, an #MF exception can occur during the execution of a 64-bit media instruction, due to a prior x87 floating-point instruction. Specifically, if an unmasked x87 floating-point exception is pending at the instruction boundary of the next 64-bit media instruction, the processor asserts the FERR# output signal. For details about the x87 floating-point exceptions and the FERR# output signal, as described in “x87 Floating-Point Exception Causes” on page 347.

5.12 Actions Taken on Executing 64-Bit Media Instructions

The MMX registers are mapped onto the low 64 bits of the 80-bit x87 floating-point physical registers, FPR0–FPR7, described in “Registers” on page 295. The MMX instructions do not use the x87 stack-addressing mechanism. However, 64-bit media instructions write certain values in the x87 top-of-stack pointer, tag bits, and high bits of the FPR0–FPR7 data registers.

Specifically, the processor performs the following x87-related actions atomically with the execution of 64-bit media instructions:

- *Top-Of-Stack Pointer (TOP)*—The processor clears the x87 top-of-stack pointer (bits 13–11 in the x87 status word register) to all 0s during the execution of every 64-bit media instruction, causing it to point to the *mmx0* register.
- *Tag Bits*—During the execution of every 64-bit media instruction, except the EMMS and FEMMS instructions, the processor changes the tag state for all eight MMX registers to *full*, as described below. In the case of EMMS and FEMMS, the processor changes the tag state for all eight MMX registers to *empty*, thus initializing the stack for an x87 floating-point procedure.
- *Bits 79–64*—During the execution of every 64-bit media instruction that writes a result to an MMX register, the

processor writes the result data to a 64-bit MMX register (the low 64 bits of the associated 80-bit x87 floating-point physical register) and sets the exponent and sign bits (the high 16 bits of the associated 80-bit x87 floating-point physical register) to all 1s. In the x87 environment, the effect of setting the high 16 bits to all 1s indicates that the contents of the low 64 bits are not finite numbers. Such a designation prevents an x87 floating-point instruction from interpreting the data as a finite x87 floating-point number.

The rest of the x87 floating-point processor state—the entire x87 control-word register, the remaining fields of the status-word register, and the error pointers (instruction pointer, data pointer, and last opcode register)—is not affected by the execution of 64-bit media instructions.

The 2-bit tag fields defined by the x87 architecture for each x87 data register, and stored in the x87 tag-word register (also called the floating-point tag word, or FTW), characterize the contents of the MMX registers. The tag bits are visible to software only after an FSAVE or FNSAVE (but not FXSAVE) instruction, as described in “Saving Media and x87 Processor State” in Volume 2. Internally, however, the processor maintains only a one-bit representation of each 2-bit tag field. This single bit indicates whether the associated register is *empty* or *full*. Table 5-6 shows the mapping between the 1-bit internal tag—which is referred to in this chapter by its *empty* or *full* state—and the 2-bit architectural tag.

Table 5-6. Mapping Between Internal and Software-Visible Tag Bits

Architectural State		Internal State ¹
State	Binary Value	
Valid	00	Full (0)
Zero	01	
Special (NaN, infinity, denormal) ²	10	
Empty	11	Empty (1)

Notes:

1. For a more detailed description of this mapping, see “Deriving FSAVE Tag Field from FXSAVE Tag Field” in Volume 2.
2. The 64-bit media floating point (3DNow!™) instructions do not support NaNs, infinities, and denormals.

When the processor executes an FSAVE or FNSAVE (but not FXSAVE) instruction, it changes the internal 1-bit tag state to its 2-bit architectural tag by reading the data in all 80 bits of the physical data registers and using the mapping in Table 5-6. For example, if the value in the high 16 bits of the 80-bit physical register indicate a NaN, the two tag bits for that register are changed to a binary value of 10 before the x87 status word is written to memory.

The tag bits have no effect on the execution of 64-bit media instructions or their interpretation of the contents of the MMX registers. However, the converse is not true: execution of 64-bit media instructions that write to an MMX register alter the tag bits and thus may affect execution of subsequent x87 floating-point instructions.

For a more detailed description of the mapping shown in Table 5-6, see “Deriving FSAVE Tag Field from FXSAVE Tag Field” in Volume 2 and its accompanying text.

5.13 Mixing Media Code with x87 Code

5.13.1 Mixing Code

Software may freely mix 64-bit media instructions (integer or floating-point) with 128-bit media instructions (integer or floating-point) and general-purpose instructions in a single procedure. However, before transitioning from a 64-bit media

procedure—or a 128-bit media procedure that accesses an MMX™ register—to an x87 procedure, or to software that may eventually branch to an x87 procedure, software should clear the MMX state, as described immediately below.

5.13.2 Clearing MMX™ State

Software should separate 64-bit media procedures, 128-bit media procedures, or dynamic link libraries (DLLs) that access MMX registers from x87 floating-point procedures or DLLs by clearing the MMX state with the EMMS or FEMMS instruction before leaving a 64-bit media procedure, as described in “Exit Media State” on page 255.

The 64-bit media instructions and x87 floating-point instructions interpret the contents of their aliased MMX and x87 registers differently. Because of this, software should not exchange register data between 64-bit media and x87 floating-point procedures, or use conditional branches at the end of loops that might jump to code of the other type. Software must not rely on the contents of the aliased MMX and x87 registers across such code-type transitions. If a transition to an x87 procedure occurs from a 64-bit media procedure that does not clear the MMX state, the x87 stack may overflow.

5.14 State-Saving

5.14.1 Saving and Restoring State

In general, system software should save and restore MMX™ and x87 state between task switches or other interventions in the execution of 64-bit media procedures. Virtually all modern operating systems running on x86 processors—including such systems as Windows NT™, UNIX, and OS/2—are preemptive multitasking operating systems that handle such saving and restoring of state properly across task switches, independently of hardware task-switch support.

No changes are needed to the x87 register-saving performed by 32-bit operating systems, exception handlers, or device drivers. The same support provided in a 32-bit operating system’s device-not-available (#NM) exception handler by any of the x87-register save/restore instructions described below also supports saving and restoring the MMX registers.

However, application procedures are also free to save and restore MMX and x87 state at any time they deem useful.

5.14.2 State-Saving Instructions

Software running at any privilege level may save and restore 64-bit media and x87 state by executing the FSAVE, FNSAVE, or FXSAVE instruction. Alternatively, software may use move instructions for saving only the contents of the MMX registers, rather than the complete 64-bit media and x87 state. For example, when saving MMX register values, use eight MOVQ instructions.

FSAVE/FNSAVE and FRSTOR Instructions. The FSAVE, FNSAVE, and FRSTOR instructions are described in “Save and Restore 64-Bit Media and x87 State” on page 272. After saving state with FSAVE or FNSAVE, the tag bits for all MMX and x87 registers are changed to *empty* and thus available for a new procedure. Thus, FSAVE and FNSAVE also perform the state-clearing function of EMMS or FEMMS.

FXSAVE and FXRSTOR Instructions. The FSAVE, FNSAVE, and FRSTOR instructions are described in “Save and Restore 128-Bit, 64-Bit, and x87 State” on page 273. The FXSAVE and FXRSTOR instructions execute faster than FSAVE/FNSAVE and FRSTOR because they do not save and restore the x87 error pointers (described in “Pointers and Opcode State” on page 305) except in the relatively rare cases in which the exception-summary (ES) bit in the x87 status word (register image for FXSAVE, memory image for FXRSTOR) is set to 1, indicating that an unmasked x87 exception has occurred.

Unlike FSAVE and FNSAVE, however, FXSAVE does not alter the tag bits (thus, it does not perform the state-clearing function of EMMS or FEMMS). The state of the saved MMX and x87 registers is retained, thus indicating that the registers may still be valid (or whatever other value the tag bits indicated prior to the save). To invalidate the contents of the MMX and x87 registers after FXSAVE, software must explicitly execute a FINIT instruction. Also, FXSAVE (like FNSAVE) and FXRSTOR do not check for pending unmasked x87 floating-point exceptions. An FWAIT instruction can be used for this purpose.

For details about the FXSAVE and FXRSTOR memory formats, see “Saving Media and x87 Processor State” in Volume 2.

5.15 Performance Considerations

In addition to typical code optimization techniques, such as those affecting loops and the inlining of function calls, the following considerations may help improve the performance of application programs written with 64-bit media instructions.

These are implementation-independent performance considerations. Other considerations depend on the hardware implementation. For information about such implementation-dependent considerations and for more information about application performance in general, see the data sheets and the software-optimization guides relating to particular hardware implementations.

5.15.1 Use Small Operand Sizes

The performance advantages available with 64-bit media operations is to some extent a function of the data sizes operated upon. The smaller the data size, the more data elements that can be packed into single 64-bit vectors. The parallelism of computation increases as the number of elements per vector increases.

5.15.2 Reorganize Data for Parallel Operations

Much of the performance benefit from the 64-bit media instructions comes from the parallelism inherent in vector operations. It can be advantageous to reorganize data before performing arithmetic operations so that its layout after reorganization maximizes the parallelism of the arithmetic operations.

The speed of memory access is particularly important for certain types of computation, such as graphics rendering, that depend on the regularity and locality of data-memory accesses. For example, in matrix operations, performance is high when operating on the rows of the matrix, because row bytes are contiguous in memory, but lower when operating on the columns of the matrix, because column bytes are not contiguous in memory and accessing them can result in cache misses. To improve performance for operations on such columns, the matrix should first be transposed. Such transpositions can, for example, be done using a sequence of unpacking or shuffle instructions.

5.15.3 Remove Branches

Branch can be replaced with 64-bit media instructions that simulate predicated execution or conditional moves, as described in “Branch Removal” on page 242. Where possible,

break long dependency chains into several shorter dependency chains which can be executed in parallel. This is especially important for floating-point instructions because of their longer latencies.

5.15.4 **Align Data**

Data alignment is particularly important for performance when data written by one instruction is read by a subsequent instruction soon after the write, or when accessing streaming (non-temporal) data—data that will not be reused and therefore should not be cached. These cases may occur frequently in 64-bit media procedures.

Accesses to data stored at unaligned locations may benefit from on-the-fly software alignment or from repetition of data at different alignment boundaries, as required by different loops that process the data.

5.15.5 **Organize Data for Cacheability**

Pack small data structures into cache-line-size blocks. Organize frequently accessed constants and coefficients into cache-line-size blocks and prefetch them. Procedures that access data arranged in memory-bus-sized blocks, or memory-burst-sized blocks, can make optimum use of the available memory bandwidth.

For data that will be used only once in a procedure, consider using non-cacheable memory. Accesses to such memory are not burdened by the overhead of cache protocols.

5.15.6 **Prefetch Data**

Media applications typically operate on large data sets. Because of this, they make intensive use of the memory bus. Memory latency can be substantially reduced—especially for data that will be used only once—by prefetching such data into various levels of the cache hierarchy. Software can use the PREFETCHx instructions very effectively in such cases, as described in “Cache and Memory Management” on page 80.

Some of the best places to use prefetch instructions are inside loops that process large amounts of data. If the loop goes through less than one cache line of data per iteration, partially unroll the loop to obtain multiple iterations of the loop within a cache line. Try to use virtually all of the prefetched data. This usually requires unit-stride memory accesses—those in which all accesses are to contiguous memory locations.

**5.15.7 Retain
Intermediate Results
in MMX™ Registers**

Keep intermediate results in the MMX registers as much as possible, especially if the intermediate results are used shortly after they have been produced. Avoid spilling intermediate results to memory and reusing them shortly thereafter.

6 x87 Floating-Point Programming

This chapter describes the x87 floating-point programming model. This model supports all aspects of the legacy x87 floating-point model and complies with the IEEE 754 and 854 standards for binary floating-point arithmetic. In hardware implementations of the AMD64 architecture, support for specific features of the x87 programming model are indicated by the CPUID feature bits, as described in “Feature Detection” on page 345.

6.1 Overview

6.1.1 Origins

In 1979, AMD introduced the first floating-point coprocessor for microprocessors—the AM9511 arithmetic circuit. This coprocessor performed 32-bit floating-point operations under microprocessor control. In 1980, AMD introduced the AM9512, which performed 64-bit floating-point operations. These coprocessors were second-sourced as the 8231 and 8232 coprocessors. Before then, programmers working with general-purpose microprocessors had to use much slower, vendor-supplied software libraries for their floating-point needs.

In 1985, the Institute of Electrical and Electronics Engineers published the *IEEE Standard for Binary Floating-Point Arithmetic*, also referred to as the *ANSI/IEEE Std 754-1985* standard, or *IEEE 754*. This standard defines the data types, operations, and exception-handling methods that are the basis for the x87 floating-point technology implemented in the legacy x86 architecture. In 1987, the IEEE published a more general radix-independent version of that standard, called the *ANSI/IEEE Std 854-1987* standard, or *IEEE 854* for short. The AMD64 architecture complies with both the IEEE 754 and IEEE 854 standards.

6.1.2 Compatibility

x87 floating-point instructions can be executed in any of the architecture’s operating modes. Existing x87 binary programs run in legacy and compatibility modes without modification. The support provided by the AMD64 architecture for such binaries is identical to that provided by legacy x86 architectures.

To run in 64-bit mode, x87 floating-point programs must be recompiled. The recompilation has no side effects on such programs, other than to make available the extended general-purpose registers and 64-bit virtual address space.

6.2 Capabilities

Floating-point software is typically written to manipulate numbers that are very large or very small, that require a high degree of precision, or that result from complex mathematical operations such as transcendentals. Applications that take advantage of floating-point operations include geometric calculations for graphics acceleration, scientific, statistical, and engineering applications, and process control.

The advantages of using x87 floating-point instructions include:

- Representation of all numbers in common, IEEE-754/854 formats, ensuring repeatability of results across all platforms that conform to IEEE-754/854 standards.
- Availability of separate floating-point registers. Depending on the hardware implementation of the architecture, this may allow execution of x87 floating-point instructions in parallel with execution of general-purpose and 128-bit media instructions.
- Instructions that compute absolute value, change-of-sign, round-to-integer, partial remainder, and square root.
- Instructions that compute transcendental values, including 2^x-1 , cosine, partial arc tangent, partial tangent, sine, sine with cosine, $y \cdot \log_2 x$, and $y \cdot \log_2(x+1)$. The cosine, partial arc tangent, sine, and sine with cosine instructions use angular values expressed in radians for operands and results.
- Instructions that load common constants, such as $\log_2 e$, $\log_2 10$, $\log_{10} 2$, $\log_e 2$, Pi, 1, and 0.

x87 instructions operate on data in three floating-point formats—32-bit single-precision, 64-bit double-precision, and 80-bit double-extended-precision (sometimes called extended precision)—as well as integer, and 80-bit packed-BCD formats.

x87 instructions carry out all computations using the 80-bit double-extended-precision format. When an x87 instruction reads a number from memory in 80-bit double-extended-precision format, the number can be used directly in

computations, without conversion. When an x87 instruction reads a number in a format other than double-extended-precision format, the processor first converts the number into double-extended-precision format. The processor can convert numbers back to specific formats, or leave them in double-extended-precision format when writing them to memory.

Most x87 operations for addition, subtraction, multiplication, and division specify two source operands, the first of which is replaced by the result. Instructions for subtraction and division have reverse forms which swap the ordering of operands.

6.3 Registers

Operands for the x87 instructions are located in the x87 registers or memory. Figure 6-1 shows an overview of the x87 registers.

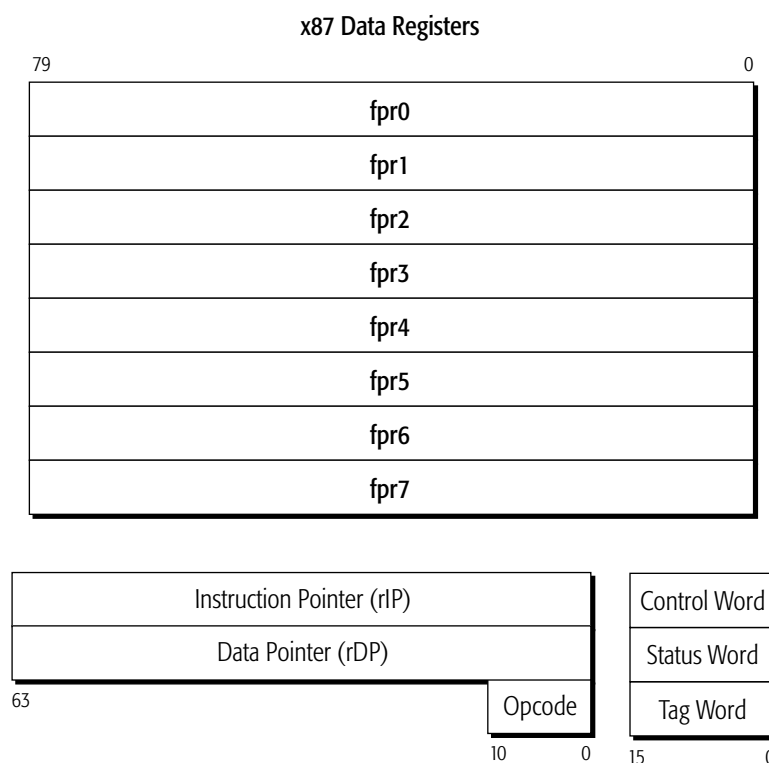

513-321.eps

Figure 6-1. x87 Registers

These registers include eight 80-bit data registers, three 16-bit registers that hold the x87 control word, status word, and tag word, two 64-bit registers that hold instruction and data pointers, and an 11-bit register that holds a permutation of an x87 opcode.

6.3.1 x87 Data Registers

Figure 6-2 shows the eight 80-bit data registers in more detail. Typically, x87 instructions reference these registers as a stack. x87 instructions store operands only in these 80-bit registers or in memory. They do not (with two exceptions) access the GPR registers, and they do not access the XMM registers.

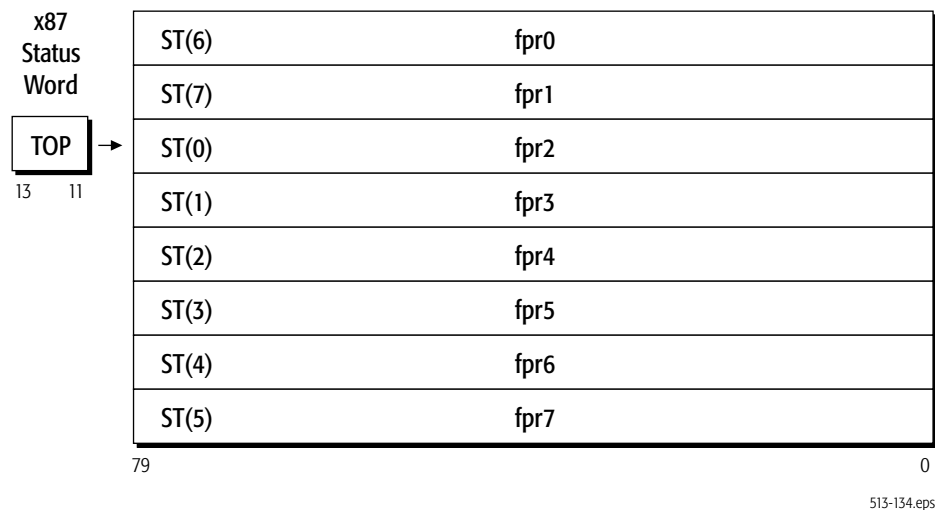

Figure 6-2. x87 Physical and Stack Registers

Stack Organization. The bank of eight physical data registers, FPR0–FPR7, are organized internally as a stack, ST(0)–ST(7). The stack functions like a circular modulo-8 buffer. The stack top can be set by software to start at any register position in the bank. Many instructions access the top of stack as well as individual registers relative to the top of stack.

Stack Pointer. Bits 13–11 of the x87 status word (“x87 Status Word Register (FSW)” on page 297) are the top-of-stack pointer (TOP). The TOP specifies the mapping of the stack registers onto the physical registers. The TOP contains the physical-register index of the location of the top of stack, ST(0). Instructions that load operands from memory into an x87

register first decrement the stack pointer and then copy the operand (often with conversion to the double-extended-precision format) from memory into the decremented top-of-stack register. Instructions that store operands from an x87 register to memory copy the operand (often with conversion from the double-extended-precision format) in the top-of-stack register to memory and then increment the stack pointer.

Figure 6-2 shows the mapping between stack registers and physical registers when the TOP has the value 2. Modulo-8 wraparound addressing is used. Pushing a new element onto this stack—for example with the FLDZ (floating-point load +0.0) instruction—decrements the TOP to 1, so that ST(0) refers to FPR1, and the new top-of-stack is loaded with +0.0.

The architecture provides alternative versions of many instructions that either modify or do not modify the TOP as a side effect. For example, FADDP (floating-point add and pop) behaves exactly like FADD (floating-point add), except that it pops the stack after completion. Programs that use the x87 registers as a flat register file rather than as a stack would use non-popping versions of instructions to ensure that the TOP remains unchanged. However, loads (pushes) without corresponding pops can cause the stack to overflow, which occurs when a value is pushed or loaded into an x87 register that is not empty (as indicated by the register's tag bits). To prevent overflow, the FXCH (floating-point exchange) instruction can be used to access stack registers, giving the appearance of a flat register file, but all x87 programs must be aware of the register file's stack organization.

The FINCSTP and FDECSTP instructions can be used to increment and decrement, respectively, the TOP, modulo-8, allowing the stack top to wrap around to the bottom of the eight-register file when incremented beyond the top of the file, or to wrap around to the top of the register file when decremented beyond the bottom of the file. Neither the x87 tag word nor the contents of the floating-point stack itself is updated when these instructions are used.

6.3.2 x87 Status Word Register (FSW)

The 16-bit x87 status word register contains information about the state of the floating-point unit, including the top-of-stack pointer (TOP), four condition-code bits, exception-summary flag, stack-fault flag, and six x87 floating-point exception flags. Figure 6-3 on page 298 shows the format of this register. All bits

can be read and written, however values written to the B and ES bits (bits 15 and 7) are ignored.

The FRSTOR and FXRSTOR instructions load the status word from memory. The FSTSW, FNSTSW, FSAVE, FNSAVE, FXSAVE, FSTENV, and FNSTENV instructions store the status word to memory. The FCLEX and FNCLEX instructions clear the exception flags. The FINIT and FNINIT instructions clear all bits in the status-word.

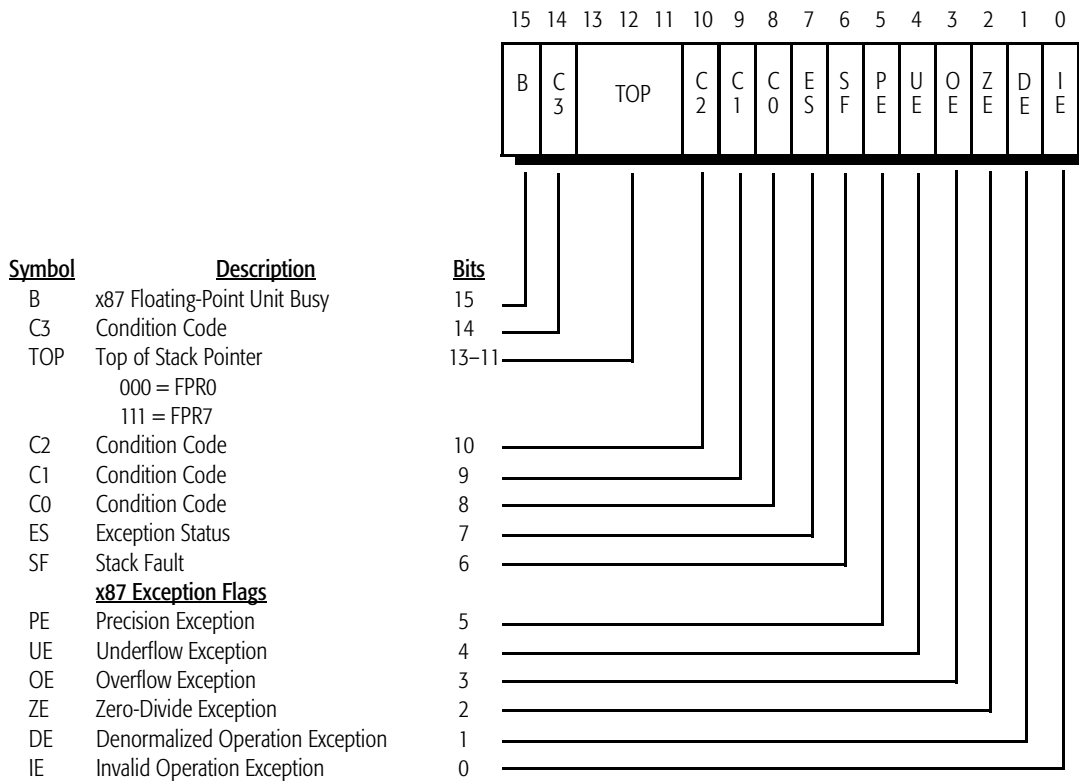

Figure 6-3. x87 Status Word Register (FSW)

The bits in the x87 status word are defined immediately below, starting with bit 0. The six exception flags (IE, DE, ZE, OE, UE, PE) plus the stack fault (SF) flag are sticky bits. Once set by the processor, such a bit remains set until software clears it. For details about the causes of x87 exceptions indicated by bits 6–0, see “x87 Floating-Point Exception Causes” on page 347. For details about the masking of x87 exceptions, see “x87 Floating-Point Exception Masking” on page 353.

Invalid-Operation Exception (IE). Bit 0. The processor sets this bit to 1 when an invalid-operation exception occurs. These exceptions are caused by many types of errors, such as an invalid operand or by stack faults. When a stack fault causes an IE exception, the stack fault (SF) exception bit is also set.

Denormalized-Operand Exception (DE). Bit 1. The processor sets this bit to 1 when one of the source operands of an instruction is in denormalized form. (See “Denormalized (Tiny) Numbers” on page 314.)

Zero-Divide Exception (ZE). Bit 2. The processor sets this bit to 1 when a non-zero number is divided by zero.

Overflow Exception (OE). Bit 3. The processor sets this bit to 1 when the absolute value of a rounded result is larger than the largest representable normalized floating-point number for the destination format. (See “Normalized Numbers” on page 314.)

Underflow Exception (UE). Bit 4. The processor sets this bit to 1 when the absolute value of a rounded non-zero result is too small to be represented as a normalized floating-point number for the destination format. (See “Normalized Numbers” on page 314.)

The underflow exception has an unusual behavior. When masked by the UM bit (bit 4 of the x87 control word), the processor only reports a UE exception if the UE occurs *together with* a precision exception (PE).

Precision Exception (PE). Bit 5. The processor sets this bit to 1 when a floating-point result, after rounding, differs from the infinitely precise result and thus cannot be represented exactly in the specified destination format. The PE exception is also called the *inexact-result* exception.

Stack Fault (SF). Bit 6. The processor sets this bit to 1 when a stack overflow (due to a push or load into a non-empty stack register) or stack underflow (due to referencing an empty stack register) occurs in the x87 stack-register file. When either of these conditions occur, the processor also sets the invalid-operation exception (IE) flag, and the processor distinguishes overflow from underflow by writing the condition-code 1 (C1) bit (C1 = 1 for overflow, C1 = 0 for underflow). Unlike the flags for the

other x87 exceptions, the SF flag does not have a corresponding mask bit in the x87 control word.

If, subsequent to the instruction that caused the SF bit to be set, a second invalid-operation exception (IE) occurs due to an invalid operand in an arithmetic instruction (i.e., not a stack fault), and if software has not cleared the SF bit between the two instructions, the SF bit will remain set.

Exception Status (ES). Bit 7. The processor calculates the value of this bit at each instruction boundary and sets the bit to 1 when one or more unmasked floating-point exceptions occur. If the ES bit has already been set by the action of some prior instruction, the processor invokes the #MF exception handler when the next non-control x87 or 64-bit media instruction is executed. (See “Control” on page 340 for a definition of control instructions).

The ES bit can be written, but the written value is ignored. Like the SF bit, the ES bit does not have a corresponding mask bit in the x87 control word.

Top-of-Stack Pointer (TOP). Bits 13–11. The TOP contains the physical register index of the location of the top of stack, ST(0). It thus specifies the mapping of the x87 stack registers, ST(0)–ST(7), onto the x87 physical registers, FPR0–FPR7. The processor changes the TOP during any instructions that pushes or pops the stack. For details on how the stack works, see “Stack Organization” on page 296.

Condition Codes (C3–C0). Bits 14 and 10–8. The processor sets these bits according to the result of arithmetic, compare, and other instructions. In certain cases, other status-word flags can be used together with the condition codes to determine the result of an operation, including stack overflow, stack underflow, sign, least-significant quotient bits, last-rounding direction, and out-of-range operand. For details on how each instruction sets the condition codes, see “x87 Floating-Point Instruction Reference” in Volume 5.

x87 Floating-Point Unit Busy (B). Bit 15. The processor sets the value of this bit equal to the calculated value of the ES bit, bit 7. This bit can be written, but the written value is ignored. The bit is included only for backward-compatibility with the 8087 coprocessor, in which it indicates that the coprocessor is busy.

For further details about the x87 floating-point exceptions, see “x87 Floating-Point Exception Causes” on page 347.

6.3.3 x87 Control Word Register (FCW)

The 16-bit x87 control word register allows software to manage certain x87 processing options, including rounding, precision, and masking of the six x87 floating-point exceptions (any of which is reported as an #MF exception). Figure 6-4 shows the format of the control word. All bits, except reserved bits, can be read and written.

The FLDCW, FRSTOR, and FXRSTOR instructions load the control word from memory. The FSTCW, FNSTCW, FSAVE, FNSAVE, and FXSAVE instructions store the control word to memory. The FINIT and FNINIT instructions initialize the control word with the value 037Fh, which specifies round-to-nearest, all exceptions masked, and double-extended precision (64-bit).

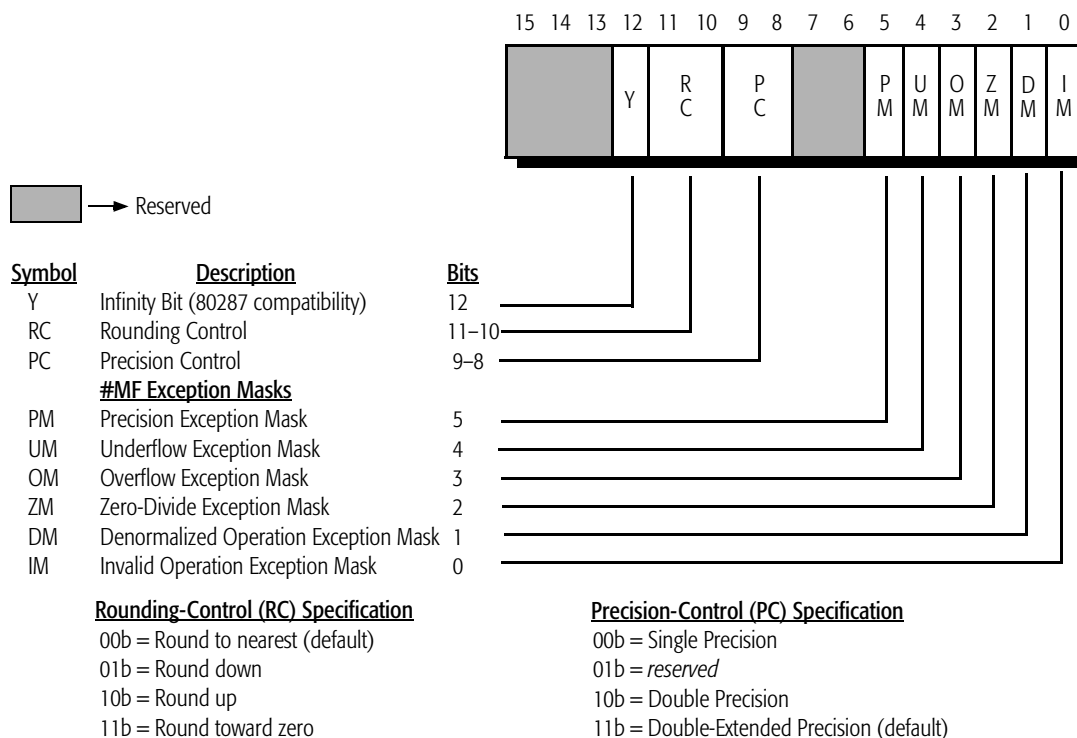

Figure 6-4. x87 Control Word Register (FCW)

Starting from bit 0, the bits are:

Exception Masks (PM, UM, OM, ZM, DM, IM). Bits 5–0. Software can set these bits to mask, or clear these bits to unmask, the corresponding six types of x87 floating-point exceptions (PE, UE, OE, ZE, DE, IE), which are reported in the x87 status word as described in “x87 Status Word Register (FSW)” on page 297. A bit masks its exception type when set to 1, and un.masks it when cleared to 0.

Masking a type of exception causes the processor to handle all subsequent instances of the exception type in a default way. Unmasking the exception type causes the processor to branch to the #MF exception service routine when an exception occurs. For details about the processor’s responses to masked and unmasked exceptions, see “x87 Floating-Point Exception Causes” on page 347.

Precision Control (PC). Bits 9–8. Software can set this field to specify the precision of x87 floating-point calculations, as shown in Table 6-1. Details on each precision are given in “Data Types” on page 308. The default precision is double-extended-precision. Precision control affects only the FADDx, FSUBx, FMULx, FDIVx, and FSQRT instructions. For further details on precision, see “Precision” on page 321.

Table 6-1. Precision Control (PC) Summary

PC Value (binary)	Data Type
00	Single precision
01	<i>reserved</i>
10	Double precision
11	Double-extended precision (default)

Rounding Control (RC). Bits 11–10. Software can set this field to specify how the results of x87 instructions are to be rounded. Table 6-2 on page 303 lists the four rounding modes, which are defined by the IEEE 754 standard.

Table 6-2. Types of Rounding

RC Value	Mode	Type of Rounding
00 (default)	Round to nearest	The rounded result is the representable value closest to the infinitely precise result. If equally close, the even value (with least-significant bit 0) is taken.
01	Round down	The rounded result is closest to, but no greater than, the infinitely precise result.
10	Round up	The rounded result is closest to, but no less than, the infinitely precise result.
11	Round toward zero	The rounded result is closest to, but no greater in absolute value than, the infinitely precise result.

Round-to-nearest is the default rounding mode. It provides a statistically unbiased estimate of the true result, and is suitable for most applications. Rounding modes apply to all arithmetic operations except comparison and remainder. They have no effect on operations that produce not-a-number (NaN) results. For further details on rounding, see “Rounding” on page 322.

Infinity Bit (Y). Bit 12. This bit is obsolete. It can be read and written, but the value has no meaning. On pre-386 processor implementations, the bit specified the affine ($Y = 1$) or projective ($Y = 0$) infinity. The AMD64 architecture uses only the affine infinity, which specifies distinct positive and negative infinity values.

6.3.4 x87 Tag Word Register (FTW)

The x87 tag word register contains a 2-bit tag field for each x87 physical data register. These tag fields characterize the register’s data. Figure 6-5 on page 304 shows the format of the tag word.

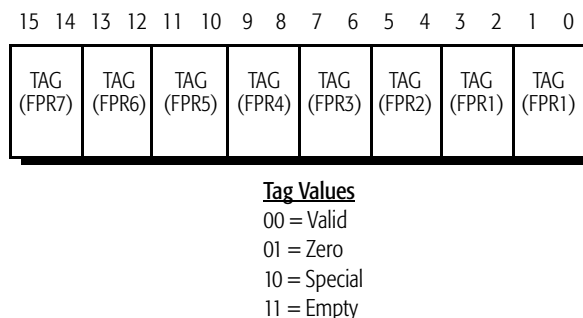

Figure 6-5. x87 Tag Word Register (FTW)

In the memory image saved by the instructions described in “x87 Environment” on page 306, each x87 physical data register has two tag bits with are encoded according to the *Tag Values* shown in Figure 6-5. Internally, the hardware may maintain only a single bit that indicates whether the associated register is *empty* or *full*. The mapping between such a 1-bit internal tag and the 2-bit software-visible architectural representation saved in memory is shown in Table 6-3. In such a mapping, whenever software saves the tag word, the processor expands the internal 1-bit tag state to the 2-bit architectural representation by examining the contents of the x87 registers, as described in “128-Bit, 64-Bit, and x87 Programming” in Volume 2.

Table 6-3. Mapping Between Internal and Software-Visible Tag Bits

Architectural State (Software-Visible)		Hardware State
State	Bit Value	
Valid	00	Full
Zero	01	
Special (NaN, infinity, denormal, or unsupported)	10	
Empty	11	Empty

The FINIT and FNINIT instructions write the tag word so that it specifies all floating-point registers as *empty*. Execution of 64-bit media instructions that write to an MMX™ register alter the tag bits by setting all the registers to *full*, and thus they may

affect execution of subsequent x87 floating-point instructions. For details, see “Mixing Media Code with x87 Code” on page 286.

6.3.5 Pointers and Opcode State

The x87 instruction pointer, instruction opcode, and data pointer are part of the x87 environment (non-data processor state) that is loaded and stored by the instructions described in “x87 Environment” on page 306. Figure 6-6 illustrates the pointer and opcode state. Execution of all x87 instructions—except control instructions (see “Control” on page 340)—causes the processor to store this state in hardware.

For convenience, the pointer and opcode state is illustrated here as registers. However, the manner of storing this state in hardware depends on the hardware implementation. The AMD64 architecture specifies only the software-visible state that is saved in memory. (See “Media and x87 Processor State” in Volume 2 for details of the memory images.)

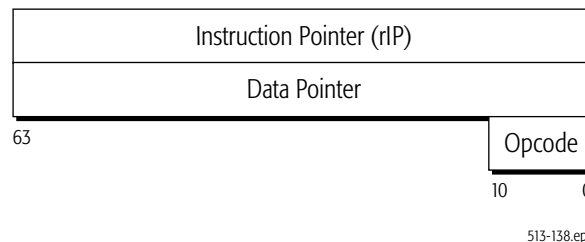

Figure 6-6. x87 Pointers and Opcode State

Last x87 Instruction Pointer. The contents of the 64-bit last-instruction pointer depends on the operating mode, as follows:

- *64-Bit Mode*—The pointer contains the 64-bit RIP offset of the last *non-control* x87 instruction executed (see “Control” on page 340 for a definition of control instructions). The 16-bit code-segment (CS) selector is not saved. (It is the operating system’s responsibility to ensure that the 64-bit state-restoration is executed in the same code segment as the preceding 64-bit state-store.)
- *Legacy Protected Mode, Legacy Virtual-8086 Mode, and Compatibility Mode*—The pointer contains the 16-bit code-segment (CS) selector and the 16-bit or 32-bit eIP offset,

depending on the effective operand size, of the last non-control x87 instruction executed.

- *Legacy Real Mode*—The pointer contains the 16-bit or 32-bit eIP offset of the last non-control x87 instruction executed.

The FINIT and FNINIT instructions clears all bits in this pointer.

Last x87 Opcode. The 11-bit instruction opcode holds a permutation of the two-byte instruction opcode from the last non-control x87 floating-point instruction executed by the processor. The opcode field is formed as follows:

- Opcode Field[10:8] = First x87-opcode byte[2:0].
- Opcode Field[7:0] = Second x87-opcode byte[7:0].

For example, the x87 opcode D9 F8 (floating-point partial remainder) is stored as 001_1111_1000b. The low-order three bits of the first opcode byte, D9 (1101_1001b), are stored in bits 10–8. The second opcode byte, F8 (1111_1000b), is stored in bits 7–0. The high-order five bits of the first opcode byte (1101_1b) are not needed because they are identical for all x87 instructions.

Last x87 Data Pointer. The contents of the 64-bit data pointer depends on the operating mode, as follows:

- *64-Bit Mode*—The pointer contains the 64-bit offset of the last memory operand accessed by the last non-control x87 instruction executed.
- *Legacy Protected Mode, Legacy Virtual-8086 Mode, and Compatibility Mode*—The pointer contains the 16-bit data-segment (DS) selector and the 16-bit or 32-bit offset of the last memory operand accessed by the last non-control x87 instruction executed.
- *Legacy Real Mode*—The pointer contains the 16-bit or 32-bit offset of the last memory operand accessed by the last non-control x87 instruction executed.

The FINIT and FNINIT instructions clears all bits in this pointer.

6.3.6 x87 Environment

The x87 environment—or non-data processor state—includes the following processor state:

- x87 control word register (FCW)

- x87 status word register (FSW)
- x87 tag word (FTW)
- last x87 instruction pointer
- last x87 data pointer
- last x87 opcode

Table 6-4 lists the x87 instructions can access this x87 processor state.

Table 6-4. Instructions that Access the x87 Environment

Instruction	Description	State Accessed
FINIT	Floating-Point Initialize	Entire Environment
FNINIT	Floating-Point No-Wait Initialize	Entire Environment
FNSAVE	Floating-Point No-Wait Save State	Entire Environment
FRSTOR	Floating-Point Restore State	Entire Environment
FSAVE	Floating-Point Save State	Entire Environment
FLDCW	Floating-Point Load x87 Control Word	x87 Control Word
FNSTCW	Floating-Point No-Wait Store Control Word	x87 Control Word
FSTCW	Floating-Point Store Control Word	x87 Control Word
FNSTSW	Floating-Point No-Wait Store Status Word	x87 Status Word
FSTSW	Floating-Point Store Status Word	x87 Status Word
FLDENV	Floating-Point Load x87 Environment	Environment, Not Including x87 Data Registers
FNSTENV	Floating-Point No-Wait Store Environment	Environment, Not Including x87 Data Registers
FSTENV	Floating-Point Store Environment	Environment, Not Including x87 Data Registers

For details on how the x87 environment is stored in memory, see “Media and x87 Processor State” in Volume 2.

6.3.7 Floating-Point Emulation (CR0.EM)

The operating system can set the floating-point software-emulation (EM) bit in control register 0 (CR0) to 1 to allow

software emulation of x87 instructions. If the operating system has set CR0.EM = 1, the processor does not execute x87 instructions. Instead, a device-not-available exception (#NM) occurs whenever an attempt is made to execute such an instruction, except that setting CR0.EM to 1 does not cause an #NM exception when the WAIT or FWAIT instruction is executed. For details, see “System-Control Registers” in Volume 2.

6.4 Operands

6.4.1 Operand Addressing

Operands for x87 instructions are referenced by the opcodes. Operands can be located either in x87 registers or memory. Immediate operands are not used in x87 floating-point instructions, and I/O ports cannot be directly addressed by x87 floating-point instructions.

Memory Operands. Most x87 floating-point instructions can take source operands from memory, and a few of the instructions can write results to memory. The following sections describe the methods and conditions for addressing memory operands:

- “Memory Addressing” on page 16 describes the general methods and conditions for addressing memory operands.
- “Instruction Prefixes” on page 344 describes the use of address-size instruction overrides by 64-bit media instructions.

Register Operands. Most x87 floating-point instructions can read source operands from and write results to x87 registers. Most instructions access the ST(0)–ST(7) register stack. For a few instructions, the register types also include the x87 control word register, the x87 status word register, and (for FSTSW and FNSTSW) the AX general-purpose register.

6.4.2 Data Types

Figure 6-7 on page 309 shows register images of the x87 data types. These include three scalar floating-point formats (80-bit double-extended-precision, 64-bit double-precision, and 32-bit single-precision), three scalar signed-integer formats (quadword, doubleword, and word), and an 80-bit packed binary-coded decimal (BCD) format. Although Figure 6-7 shows register images of the data types, the three signed-integer data types can exist only in memory. All data types are converted into an 80-bit format when they are loaded into an x87 register.

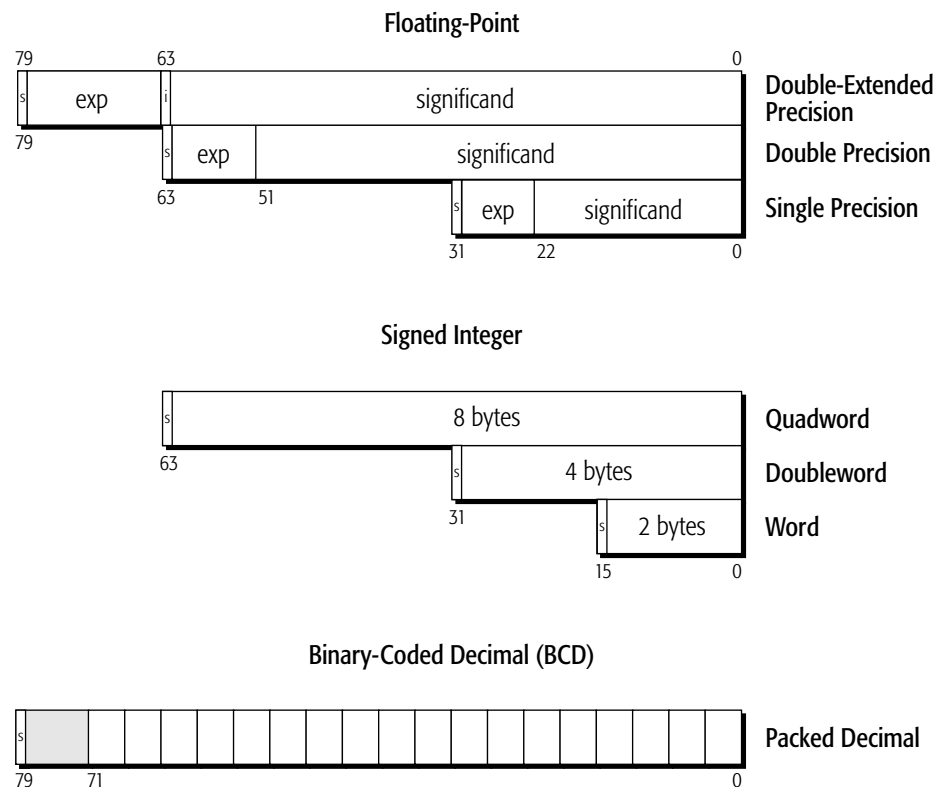

513-317.eps

Figure 6-7. x87 Data Types

Floating-Point Data Types. The floating-point data types, shown in Figure 6-8 on page 310, include 32-bit single precision, 64-bit double precision, and 80-bit double-extended precision. The default precision is double-extended precision, and all operands loaded into registers are converted into double-extended precision format.

All x87 instruction (except `FADDx`, `FSUBx`, `FSUBRx`, `FMULx`, `FDIVx`, `FDIVRx`, and `FSQRT`) operate on register values in double-extended precision format. The `FADDx`, `FSUBx`, `FSUBRx`, `FMULx`, `FDIVx`, `FDIVRx`, and `FSQRT` instructions operate on floating-point data types in the precision specified by the precision control (PC) bit in the x87 control word.

All three floating-point formats are compatible with the *IEEE Standard for Binary Floating-Point Arithmetic* (ANSI/IEEE Std 754 and 854).

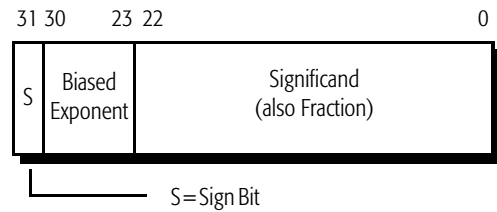
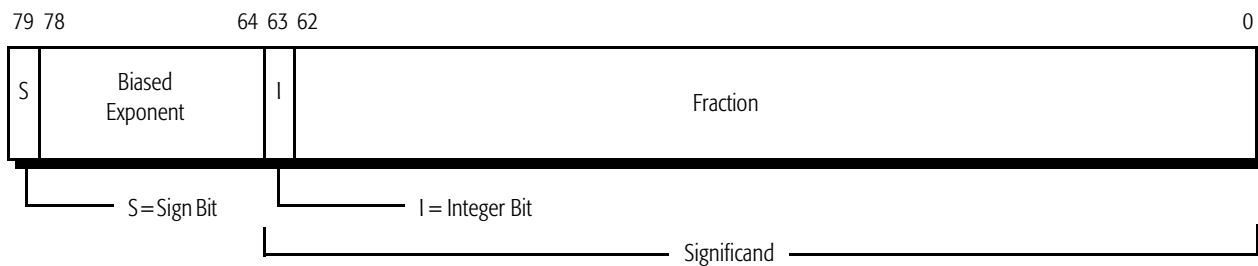
Single Precision**Double Precision****Double-Extended Precision****Figure 6-8. x87 Floating-Point Data Types**

All of the floating-point data types consist of a sign (0 = positive, 1 = negative), a biased exponent (base-2), and a significand, which represents the integer and fractional parts of the number. The integer bit (also called the *J bit*) is either implied (called a *hidden integer bit*) or explicit, depending on the data type. The value of an implied integer bit can be inferred from number encodings, as described in “Number Encodings” on page 316. The bias of the exponent is a constant which makes the exponent always positive and allows reciprocation, without overflow, of the smallest normalized number representable by that data type.

Specifically, the data types are formatted as follows:

- *Single-Precision Format*—This format includes a 1-bit sign, an 8-bit biased exponent whose value is 127, and a 23-bit significand. The integer bit is implied, making a total of 24 bits in the significand.

- *Double-Precision Format*—This format includes a 1-bit sign, an 11-bit biased exponent whose value is 1023, and a 52-bit significand. The integer bit is implied, making a total of 53 bits in the significand.
- *Double-Extended-Precision Format*—This format includes a 1-bit sign, a 15-bit biased exponent whose value is 16,383, and a 64-bit significand, which includes one explicit integer bit.

Table 6-5 shows the range of finite values representable by the three x87 floating-point data types.

Table 6-5. Range of Finite Floating-Point Values

Data Type	Range of Finite Values ¹		Precision
	Base 2	Base 10	
Single Precision	2^{-126} to $2^{127} * (2 - 2^{-23})$	$1.17 * 10^{-38}$ to $+3.40 * 10^{38}$	24 bits
Double Precision	2^{-1022} to $2^{1023} * (2 - 2^{-52})$	$2.23 * 10^{-308}$ to $+1.79 * 10^{308}$	53 bits
Double-Extended Precision	2^{-16382} to $2^{16383} * (2 - 2^{-63})$	$3.37 * 10^{-4932}$ to $+1.18 * 10^{4932}$	64 bits
Note:			
1. See "Number Representation" on page 312.			

For example, in the single-precision format, the largest normal number representable has an exponent of FEh and a significand of 7FFFFFFh, with a numerical value of $2^{127} * (2 - 2^{-23})$. Results that overflow above the maximum representable value return either the maximum representable normalized number (see "Normalized Numbers" on page 314) or infinity, with the sign of the true result, depending on the rounding mode specified in the rounding control (RC) field of the x87 control word. Results that underflow below the minimum representable value return either the minimum representable normalized number or a denormalized number (see "Denormalized (Tiny) Numbers" on page 314), with the sign of the true result, or a result determined by the x87 exception handler, depending on the rounding mode, precision mode, and underflow-exception mask (UM) in the x87 control word (see "Unmasked Responses" on page 357).

Integer Data Type. The integer data types, shown in Figure 6-7 on page 309, include two's-complement 16-bit word, 32-bit doubleword, and 64-bit quadword. These data types are used in

x87 instructions that convert signed integer operands into floating-point values. The integers can be loaded from memory into x87 registers and stored from x87 registers into memory. The data types cannot be moved between x87 registers and other registers.

For details on the format and number-representation of the integer data types, see “Data Types” on page 42.

Packed-Decimal Data Type. The 80-bit packed-decimal data type, shown in Figure 6-9, represents an 18-digit decimal integer using the binary-coded decimal (BCD) format. Each of the 18 digits is a 4-bit representation of an integer. The 18 digits use a total of 72 bits. The next-higher seven bits in the 80-bit format are reserved (ignored on loads, zeros on stores). The high bit (bit 79) is a sign bit.

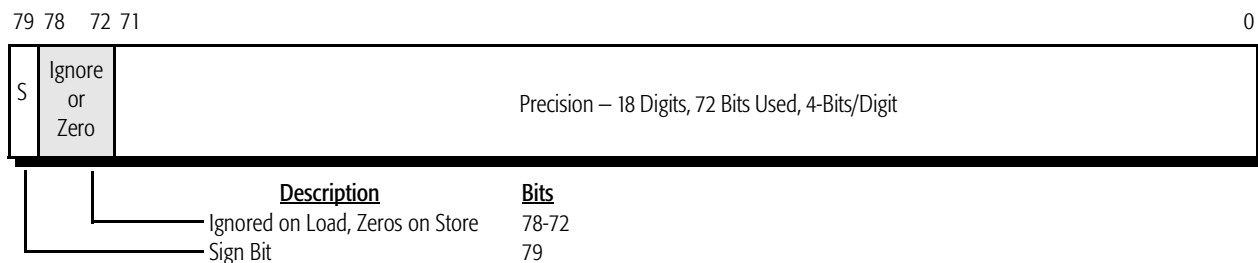

Figure 6-9. x87 Packed Decimal Data Type

Two x87 instructions operate on the packed-decimal data type. The FBLD (floating-point load binary-coded decimal) and FBSTP (floating-point store binary-coded decimal integer and pop) instructions push and pop, respectively, a packed-decimal memory operand between the floating-point stack and memory. FBLD converts the value being pushed to a double-extended-precision floating-point value. FBSTP rounds the value being popped to an integer.

For details on the format and use of 4-bit BCD integers, see “Binary-Coded-Decimal (BCD) Digits” on page 44.

6.4.3 Number Representation

Of the following types of floating-point values, six are supported by the architecture and three are not supported:

- *Supported Values*
 - Normal

- Denormal (Tiny)
- Pseudo-Denormal
- Zero
- Infinity
- Not a Number (NaN)
- *Unsupported Values*
 - Unnormal
 - Pseudo-Infinity
 - Pseudo-NaN

The supported values can be used as operands in x87 floating-point instructions. The unsupported values cause an invalid-operation exception (IE) when used as operands.

In common engineering and scientific usage, floating-point numbers—also called *real numbers*—are represented in base (radix) 10. A non-zero number consists of a *sign*, a normalized *significand*, and a signed *exponent*, as in:

+2.71828 e0

Both large and small numbers are representable in this notation, subject to the limits of data-type precision. For example, a million in base-10 notation appears as +1.00000 e6 and -0.0000383 is represented as -3.83000 e-5. A non-zero number can always be written in *normalized form*—that is, with a leading non-zero digit immediately before the decimal point. Thus, a normalized significand in base-10 notation is a number in the range [1,10). The signed exponent specifies the number of positions that the decimal point is shifted.

Unlike the common engineering and scientific usage described above, x87 floating-point numbers are represented in base (radix) 2. Like its base-10 counterpart, a normalized base-2 significand is written with its leading non-zero digit immediately to the left of the radix point. In base-2 arithmetic, a non-zero digit is always a one, so the range of a binary significand is [1,2):

+1.fraction \pm exponent

The leading non-zero digit is called the *integer bit*, and in the x87 double-extended-precision floating-point format this integer bit is explicit, as shown in Figure 6-8. In the x87 single-precision and the double-precision floating-point formats, the

integer bit is simply omitted (and called the *hidden integer bit*), because its implied value is always 1 in a normalized significand (0 in a denormalized significand), and the omission allows an extra bit of precision.

The following sections describe the supported number representations.

Normalized Numbers. Normalized floating-point numbers are the most frequent operands for x87 instructions. These are finite, non-zero, positive or negative numbers in which the integer bit is 1, the biased exponent is non-zero and non-maximum, and the fraction is any representable value. Thus, the significand is within the range of $[1, 2)$. Whenever possible, the processor represents a floating-point result as a normalized number.

Denormalized (Tiny) Numbers. Denormalized numbers (also called *tiny* numbers) are smaller than the smallest representable normalized numbers. They arise through an underflow condition, when the exponent of a result lies below the representable minimum exponent. These are finite, non-zero, positive or negative numbers in which the integer bit is 0, the biased exponent is 0, and the fraction is non-zero.

The processor generates a denormalized-operand exception (DE) when an instruction uses a denormalized *source operand*. The processor may generate an underflow exception (UE) when an instruction produces a rounded, non-zero *result* that is too small to be represented as a normalized floating-point number in the destination format, and thus is represented as a denormalized number. If a result, after rounding, is too small to be represented as the minimum denormalized number, it is represented as zero. (See “Exceptions” on page 346 for specific details.)

Denormalization may correct the exponent by placing leading zeros in the significand. This may cause a loss of precision, because the number of significant bits in the fraction is reduced by the leading zeros. In the single-precision floating-point format, for example, normalized numbers have biased exponents ranging from 1 to 254 (the unbiased exponent range is from -126 to $+127$). A true result with an exponent of, say, -130 , undergoes denormalization by right-shifting the significand by the difference between the normalized exponent and the minimum exponent, as shown in Table 6-6.

Table 6-6. Example of Denormalization

Significand (base 2)	Exponent	Result Type
1.0011010000000000	-130	True result
0.0001001101000000	-126	Denormalized result

Pseudo-Denormalized Numbers. Pseudo-denormalized numbers are positive or negative numbers in which the integer bit is 1, the biased exponent is 0, and the fraction is any value. The processor accepts pseudo-denormal source operands but it does not produce pseudo-denormal results. When a pseudo-denormal number is used as a source operand, the processor treats the arithmetic value of its biased exponent as 1 rather than 0, and the processor generates a denormalized-operand exception (DE).

Zero. The floating-point zero is a finite, positive or negative number in which the integer bit is 0, the biased exponent is 0, and the fraction is 0. The sign of a zero result depends on the operation being performed and the selected rounding mode. It may indicate the direction from which an underflow occurred, or it may reflect the result of a division by $+\infty$ or $-\infty$.

Infinity. Infinity is a positive or negative number, $+\infty$ and $-\infty$, in which the integer bit is 1, the biased exponent is maximum, and the fraction is 0. The infinities are the maximum numbers that can be represented in floating-point format. Negative infinity is less than any finite number and positive infinity is greater than any finite number (i.e., the affine sense).

An infinite result is produced when a non-zero, non-infinite number is divided by 0 or multiplied by infinity, or when infinity is added to infinity or to 0. Arithmetic on infinities is exact. For example, adding any floating-point number to $+\infty$ gives a result of $+\infty$. Arithmetic comparisons work correctly on infinities. Exceptions occur only when the use of an infinity as a source operand constitutes an invalid operation.

Not a Number (NaN). NaNs are non-numbers, lying outside the range of representable floating-point values. The integer bit is 1, the biased exponent is maximum, and the fraction is non-zero. NaNs are of two types:

- *Signaling NaN (SNaN)*
- *Quiet NaN (QNaN)*

A QNaN is a NaN with the most-significant fraction bit set to 1, and an SNaN is a NaN with the most-significant fraction bit cleared to 0. When the processor encounters an SNaN as a source operand for an instruction, an invalid-operation exception (IE) occurs and a QNaN is produced as the result, if the exception is masked. In general, when the processor encounters a QNaN as a source operand for an instruction—in an instruction other than FxCOMx, FISTx, or FSTx—the processor does not generate an exception but generates a QNaN as the result.

The processor never generates an SNaN as a result of a floating-point operation. When an invalid-operation exception (IE) occurs due to an SNaN operand, the invalid-operation exception mask (IM) bit determines the processor's response, as described in “x87 Floating-Point Exception Masking” on page 353.

When a floating-point operation or exception produces a QNaN result, its value is derived from the source operands according to the rules shown in Table 6-7 on page 317.

6.4.4 Number Encodings

Supported Encodings. Table 6-8 on page 318 shows the floating-point encodings of supported numbers and non-numbers. The number categories are ordered from large to small. In this affine ordering, positive infinity is larger than any positive normalized number, which in turn is larger than any positive denormalized number, which is larger than positive zero, and so forth. Thus, the ordinary rules of comparison apply between categories as well as within categories, so that comparison of any two numbers is well-defined.

The actual exponent field length is 8, 11, or 15 bits, and the fraction field length is 23, 52, or 63 bits, depending on operand precision.

Table 6-7. NaN Results from NaN Source Operands

Source Operand (in either order) ¹		NaN Result ²
QNaN	Any non-NaN floating-point value (or single-operand instruction)	Value of QNaN
SNaN	Any non-NaN floating-point value (or single-operand instruction)	Value of SNaN, converted to a QNaN ³
QNaN	QNaN	Value of QNaN with the larger significand ⁴
QNaN	SNaN	Value of QNaN
SNaN	QNaN	Value of QNaN
SNaN	SNaN	Value of SNaN with the larger significand ⁴
Notes:		
1. This table does not include NaN source operands used in FxCOMx, FISTx, or FSTx instructions.		
2. A NaN result is produced when the floating-point invalid-operation exception is masked.		
3. The conversion is done by changing the most-significant fraction bit to 1.		
4. If the significands of the source operands are equal but their signs are different, the NaN result is undefined.		

The single-precision and double-precision formats do not include the integer bit in the significand (the value of the integer bit can be inferred from number encodings). The double-extended-precision format explicitly includes the integer in bit 63 and places the most-significant fraction bit in bit 62. Exponents of all three types are encoded in biased format, with respective biasing constants of 127, 1023, and 16,383.

Table 6-8. Supported Floating-Point Encodings

Classification		Sign	Biased Exponent ¹	Significand ²
Positive Non-Numbers	SNaN	0	111 ... 111	1.011 ... 111 to 1.000 ... 001
	QNaN	0	111 ... 111	1.111 ... 111 to 1.100 ... 000
Positive Floating-Point Numbers	Positive Infinity (+∞)	0	111 ... 111	1.000 ... 000
	Positive Normal	0	111 ... 110 to 000 ... 001	1.111 ... 111 to 1.000 ... 000
	Positive Pseudo-Denormal ³	0	000 ... 000	1.111 ... 111 to 1.000 ... 001
	Positive Denormal	0	000 ... 000	0.111 ... 111 to 0.000 ... 001
	Positive Zero	0	000 ... 000	0.000 ... 000

Notes:

1. The actual exponent field length is 8, 11, or 15 bits, depending on operand precision.
2. The "1." and "0." prefixes represent the implicit or explicit integer bit. The actual fraction field length is 23, 52, or 63 bits, depending on operand precision.
3. Pseudo-denormals can only occur in double-extended-precision format, because they require an explicit integer bit.
4. The floating-point indefinite value is a QNaN with a negative sign and a significand whose value is 1.100 ... 000.

Table 6-8. Supported Floating-Point Encodings (continued)

Classification		Sign	Biased Exponent ¹	Significand ²
Negative Floating-Point Numbers	Negative Zero	1	000 ... 000	0.000 ... 000
	Negative Denormal	1	000 ... 000	0.000 ... 001 to 0.111 ... 111
	Negative Pseudo-Denormal ³	1	000 ... 000	1.000 ... 001 to 1.111 ... 111
	Negative Normal	1	000 ... 001 to 111 ... 110	1.000 ... 000 to 1.111 ... 111
	Negative Infinity ($-\infty$)	1	111 ... 111	1.000 ... 000
Negative Non-Numbers	SNaN	1	111 ... 111	1.000 ... 001 to 1.011 ... 111
	QNaN ⁴	1	111 ... 111	1.100 ... 000 to 1.111 ... 111
Notes:				
1. The actual exponent field length is 8, 11, or 15 bits, depending on operand precision.				
2. The "1." and "0." prefixes represent the implicit or explicit integer bit. The actual fraction field length is 23, 52, or 63 bits, depending on operand precision.				
3. Pseudo-denormals can only occur in double-extended-precision format, because they require an explicit integer bit.				
4. The floating-point indefinite value is a QNaN with a negative sign and a significand whose value is 1.100 ... 000.				

Unsupported Encodings. Table 6-9 on page 320 shows the encodings of unsupported values. These values can exist only in the double-extended-precision format, because they require an explicit integer bit. The processor does not generate them as results, and they cause an invalid-operation exception (IE) when used as source operands.

Indefinite Values. Floating-point, integer, and packed-decimal data types each have a unique encoding that represents an *indefinite value*. The processor returns an indefinite value when a masked invalid-operation exception (IE) occurs.

For example, if a floating-point arithmetic operation is attempted using a source operand which is in an unsupported format, and IE exceptions are masked, the floating-point

indefinite value is returned as the result. Or, if an integer store instruction overflows its destination data type, and IE exceptions are masked, the integer indefinite value is returned as the result.

Table 6-9. Unsupported Floating-Point Encodings

Classification	Sign	Biased Exponent ¹	Significand ²
Positive Pseudo-NaN	0	111 ... 111	0.111 ... 111 to 0.000 ... 001
Positive Pseudo-Infinity	0	111 ... 111	0.000 ... 000
Positive Unnormal	0	111 ... 110 to 000 ... 001	0.111 ... 111 to 0.000 ... 000
Negative Unnormal	1	000 ... 001 to 111 ... 110	0.000 ... 000 to 0.111 ... 111
Negative Pseudo-Infinity	1	111 ... 111	0.000 ... 000
Negative Pseudo-NaN	1	111 ... 111	0.000 ... 001 to 0.111 ... 111
Notes:			
1. The actual exponent field length is 15 bits.			
2. The "0." prefix represent the explicit integer bit. The actual fraction field length is 63 bits.			

Table 6-10 on page 321 shows the encodings of the indefinite values for each data type. For floating-point numbers, the indefinite value is a special form of QNaN. For integers, the indefinite value is the largest representable negative two's-complement number, 80...00h. (This value is interpreted as the largest representable negative number, except when a masked IE exception occurs, in which case it is interpreted as an indefinite value.) For packed-decimal numbers, the indefinite value has no other meaning than indefinite.

Table 6-10. Indefinite-Value Encodings

Data Type	Indefinite Encoding
Floating-Point	<ul style="list-style-type: none"> • sign bit = 1 • biased exponent = 111 ... 111 • significand integer bit = 1 • significand fraction = 100 ... 000
Integer	<ul style="list-style-type: none"> • sign bit = 1 • integer = 000 ... 000
Packed-Decimal	<ul style="list-style-type: none"> • bit 79 (sign bit) = 1 • bits 78–72 = 1111111 • bits 71–64 = 11111111 • bits 63–0 = any value

6.4.5 Precision

Bits 9–8 of the x87 control word (“x87 Control Word Register (FCW)” on page 301) comprise the precision control (PC) field, which specifies the precision of floating-point calculations for the FADD_x, FSUB_x, FMUL_x, FDIV_x, and FSQRT instructions, as shown in Table 6-11.

Table 6-11. Precision Control Field (PC) Values and Bit Precision

PC Field	Data Type	Precision (bits)
00	Single precision	24 ¹
01	<i>reserved</i>	
10	Double precision	53 ¹
11	Double-extended precision	64
Note:		
1. The single-precision and double-precision bit counts include the implied integer bit.		

The default precision is double-extended-precision. Selecting double-precision or single-precision reduces the size of the significand to 53 bits or 24 bits, respectively, to satisfy the IEEE standard for these floating-point types. This allows exact replication, on different IEEE-compliant processors, of calculations done using these lower-precision data types. When using reduced precision, rounding clears the unused bits on the right of the significand to 0s.

6.4.6 Rounding

Bits 11–10 of the x87 control word (“x87 Control Word Register (FCW)” on page 301) comprise the rounding control (RC) field, which specifies how the results of x87 floating-point computations are rounded. Rounding modes apply to most arithmetic operations but not to comparison or remainder. They have no effect on operations that produce NaN results.

The IEEE 754 standard defines the four rounding modes as shown in Table 6-12.

Table 6-12. Types of Rounding

RC Value	Mode	Type of Rounding
00 (default)	Round to nearest	The rounded result is the representable value closest to the infinitely precise result. If equally close, the even value (with least-significant bit 0) is taken.
01	Round down	The rounded result is closest to, but no greater than, the infinitely precise result.
10	Round up	The rounded result is closest to, but no less than, the infinitely precise result.
11	Round toward zero	The rounded result is closest to, but no greater in absolute value than, the infinitely precise result.

Round to nearest is the default rounding mode. It provides a statistically unbiased estimate of the true result, and is suitable for most applications. The other rounding modes are directed roundings: round up (toward $+\infty$), round down (toward $-\infty$), and round toward zero. Round up and round down are used in interval arithmetic, in which upper and lower bounds bracket the true result of a computation. Round toward zero takes the smaller in magnitude, that is, always truncates.

The processor produces a floating-point result defined by the IEEE standard to be infinitely precise. This result may not be representable exactly in the destination format, because only a subset of the continuum of real numbers finds exact representation in any particular floating-point format. Rounding modifies such a result to conform to the destination format, thereby making the result inexact and also generating a precision exception (PE), as described in “x87 Floating-Point Exception Causes” on page 347.

Suppose, for example, the following 24-bit result is to be represented in single-precision format, where “E₂ 1010” represents the biased exponent:

```
1.0011 0101 0000 0001 0010 0111 E2 1010
```

This result has no exact representation, because the least-significant 1 does not fit into the single-precision format, which allows for only 23 bits of fraction. The rounding control field determines the direction of rounding. Rounding introduces an error in a result that is less than one *unit in the last place (ulp)*, that is, the least-significant bit position of the floating-point representation.

6.5 Instruction Summary

This section summarizes the functions of the x87 floating-point instructions. The instructions are organized here by functional group—such as data-transfer, arithmetic, and so on. More detail on individual instructions is given in the alphabetically organized “x87 Floating-Point Instruction Reference” in Volume 5.

Software running at any privilege level can use any of these instructions, if the CUID instruction reports support for the instructions (see “Feature Detection” on page 345). Most x87 instructions take floating-point data types for both their source and destination operands, although some x87 data-conversion instructions take integer formats for their source or destination operands.

6.5.1 Syntax

Each instruction has a *mnemonic syntax* used by assemblers to specify the operation and the operands to be used for source and destination (result) data. Many of x87 instructions have the following syntax:

```
MNEMONIC st(j), st(i)
```

Figure 6-10 on page 324 shows an example of the mnemonic syntax for a floating-point add (FADD) instruction.

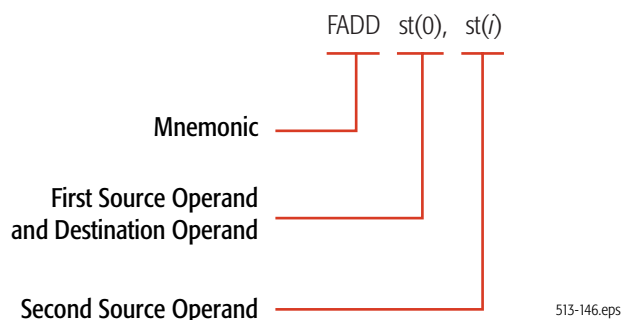

Figure 6-10. Mnemonic Syntax for Typical Instruction

This example shows the `FADD` mnemonic followed by two operands, both of which are 80-bit stack-register operands. Most instructions take source operands from an x87 stack register and/or memory and write their results to a stack register or memory. Only two of the instructions (`FSTSW` and `FNSTSW`) can access a general-purpose registers (GPR), and none access the 128-bit media (XMM) registers. Although the MMX registers map to the x87 registers, the contents of the MMX registers cannot be accessed meaningfully using x87 instructions.

Instructions can have one or more prefixes that modify default operand properties. These prefixes are summarized in “Instruction Prefixes” on page 87.

Mnemonics. The following characters are used as prefixes in the mnemonics of integer instructions:

- **F**—x87 Floating-point

In addition to the above prefix characters, the following characters are used elsewhere in the mnemonics of x87 instructions:

- **B**—Below, or BCD
- **BE**—Below or Equal
- **CMOV**—Conditional Move
- **c**—Variable condition
- **E**—Equal
- **I**—Integer

- **LD**—Load
- **N**—No Wait
- **NB**—Not Below
- **NBE**—Not Below or Equal
- **NE**—Not Equal
- **NU**—Not Unordered
- **P**—Pop
- **PP**—Pop Twice
- **R**—Reverse
- **ST**—Store
- **U**—Unordered
- **x**—One or more variable characters in the mnemonic

For example, the mnemonic for the store instruction that stores the top-of-stack and pops the stack is **FSTP**. In this mnemonic, the **F** means a floating-point instruction, the **ST** means a store, and the **P** means pop the stack.

6.5.2 Data Transfer and Conversion

The data transfer and conversion instructions copy data—in some cases with data conversion—between x87 stack registers and memory or between stack positions.

Load or Store Floating-Point.

- **FLD**—Floating-Point Load
- **FST**—Floating-Point Store Stack Top
- **FSTP**—Floating-Point Store Stack Top and Pop

The **FLD** instruction pushes the source operand onto the top-of-stack, **ST(0)**. The source operand may be a single-precision, double-precision, or double-extended-precision floating-point value in memory or the contents of a specified stack position, **ST(i)**.

The **FST** instruction copies the value at the top-of-stack, **ST(0)**, to a specified stack position, **ST(i)**, or to a 32-bit or 64-bit memory location. If the destination is a memory location, the value copied is first converted to a single-precision or double-precision floating-point value. If the top-of-stack value is a single-precision or double-precision value, **FSTP** converts it according to the rounding control (**RC**) field of the x87 control word. If the top-of-stack value is a NaN or an infinity, **FST**

truncates the stack-top exponent and significand to fit the destination size.

The FSTP instruction is similar to FST, except that FSTP can also store to an 80-bit memory location and it pops the stack after the store. FSTP can be used to clean up the x87 stack at the end of an x87 procedure by removing one register of preloaded data from the stack.

Convert and Load or Store Integer.

- FILD—Floating-Point Load Integer
- FIST—Floating-Point Integer Store
- FISTP—Floating-Point Integer Store and Pop
- FISTTP—Floating-Point Integer Truncate and Store

The FILD instruction converts the 16-bit, 32-bit, or 64-bit source signed integer in memory into a double-extended-precision floating-point value and pushes the result onto the top-of-stack, ST(0).

The FIST instruction converts and rounds the source value in the top-of-stack, ST(0), to a signed integer and copies it to the specified 16-bit or 32-bit memory location. The source may be any floating-point data type, including a single-precision, double-precision, or double-extended-precision floating-point value. The type of rounding is determined by the rounding control (RC) field of the x87 control word. The default is round-to-nearest.

The FISTP instruction is similar to FIST, except that FISTP can also store the result to a 64-bit memory location and it pops ST(0) after the store.

The FISTTP instruction converts a floating-point value in ST(0) to an integer by truncating the fractional part of the number and storing the integer result to the memory address specified by the destination operand. FISTTP then pops the floating point register stack. The FISTTP instruction ignores the rounding mode specified by the x87 control word.

Convert and Load or Store BCD.

- FBLD—Floating-Point Load Binary-Coded Decimal
- FBSTP—Floating-Point Store Binary-Coded Decimal Integer and Pop

The FBLD and FBSTP instructions, respectively, push and pop an 80-bit packed BCD memory value on and off the top-of-stack, ST(0). FBLD first converts the value being pushed to a double-extended-precision floating-point value. FBSTP rounds the value being popped to an integer, using the rounding mode specified by the RC field, and converts the value to an 80-bit packed BCD value. Thus, no FRNDIT (round-to-integer) instruction is needed prior to FBSTP.

Conditional Move.

- FCMOVB—Floating-Point Conditional Move If Below
- FCMOVBE—Floating-Point Conditional Move If Below or Equal
- FCMOVE—Floating-Point Conditional Move If Equal
- FCMOVNB—Floating-Point Conditional Move If Not Below
- FCMOVNBE—Floating-Point Conditional Move If Not Below or Equal
- FCMOVNE—Floating-Point Conditional Move If Not Equal
- FCMOVNU—Floating-Point Conditional Move If Not Unordered
- FCMOVU—Floating-Point Conditional Move If Unordered

The FCMOV cc instructions copy the contents of a specified stack position, ST(i), to the top-of-stack, ST(0), if the specified rFLAGS condition is met. Table 6-13 specifies the flag combinations for each conditional move.

Table 6-13. rFLAGS Conditions for FCMOV cc

Condition	Mnemonic	rFLAGS Register State
Below	B	Carry flag is set (CF = 1)
Below or Equal	BE	Either carry flag or zero flag is set (CF = 1 or ZF = 1)
Equal	E	Zero flag is set (ZF = 1)
Not Below	NB	Carry flag is not set (CF = 0)
Not Below or Equal	NBE	Neither carry flag nor zero flag is set (CF = 0, ZF = 0)

Table 6-13. rFLAGS Conditions for FCMOVcc

Condition	Mnemonic	rFLAGS Register State
Not Equal	NE	Zero flag is not set (ZF = 0)
Not Unordered	NU	Parity flag is not set (PF = 0)
Unordered	U	Parity flag is set (PF = 1)

Exchange.

- FXCH—Floating-Point Exchange

The FXCH instruction exchanges the contents of a specified stack position, ST(*i*), with the top-of-stack, ST(0). The top-of-stack pointer is left unchanged. In the form of the instruction that specifies no operand, the contents of ST(1) and ST(0) are exchanged.

Extract.

- FXTRACT—Floating-Point Extract Exponent and Significand

The FXTRACT instruction copies the unbiased exponent of the original value in the top-of-stack, ST(0), and writes it as a floating-point value to ST(1), then copies the significand and sign of the original value in the top-of-stack and writes it as a floating-point value with an exponent of zero to the top-of-stack, ST(0).

6.5.3 Load Constants**Load 0, 1, or Pi.**

- FLDZ—Floating-Point Load +0.0
- FLD1—Floating-Point Load +1.0
- FLDPI—Floating-Point Load Pi

The FLDZ, FLD1, and FLDPI instructions, respectively, push the floating-point constant value, +0.0, +1.0, and Pi (3.141592653...), onto the top-of-stack, ST(0).

Load Logarithm.

- FLDL2E—Floating-Point Load Log₂ e
- FLDL2T—Floating-Point Load Log₂ 10
- FLDLG2—Floating-Point Load Log₁₀ 2
- FLDLN2—Floating-Point Load Ln 2

The FLDL2E, FLDL2T, FLDLG2, and FLDLN2 instructions, respectively, push the floating-point constant value, log₂e, log₂10, log₁₀2, and log_e2, onto the top-of-stack, ST(0).

6.5.4 Arithmetic

The arithmetic instructions support addition, subtraction, multiplication, division, change-sign, round, round to integer, partial remainder, and square root. In most arithmetic operations, one of the source operands is the top-of-stack, ST(0).

The other source operand can be another stack entry, $ST(i)$, or a floating-point or integer operand in memory.

The non-commutative operations of subtraction and division have two forms, the direct FSUB and FDIV, and the reverse FSUBR and FDIVR. FSUB, for example, subtracts the right operand from the left operand, and writes the result to the left operand. FSUBR subtracts the left operand from the right operand, and writes the result to the left operand. The FADD and FMUL operations have no reverse counterparts.

Addition.

- FADD—Floating-Point Add
- FADDP—Floating-Point Add and Pop
- FIADD—Floating-Point Add Integer to Stack Top

The FADD instruction syntax has forms that include one or two explicit source operands. In the one-operand form, the instruction reads a 32-bit or 64-bit floating-point value from memory, converts it to the double-extended-precision format, adds it to $ST(0)$, and writes the result to $ST(0)$. In the two-operand form, the instruction adds both source operands from stack registers and writes the result to the first operand.

The FADDP instruction syntax has forms that include zero or two explicit source operands. In the zero-operand form, the instruction adds $ST(0)$ to $ST(1)$, writes the result to $ST(1)$, and pops the stack. In the two-operand form, the instruction adds both source operands from stack registers, writes the result to the first operand, and pops the stack.

The FIADD instruction reads a 16-bit or 32-bit integer value from memory, converts it to the double-extended-precision format, adds it to $ST(0)$, and writes the result to $ST(0)$.

Subtraction.

- FSUB—Floating-Point Subtract
- FSUBP—Floating-Point Subtract and Pop
- FISUB—Floating-Point Integer Subtract
- FSUBR—Floating-Point Subtract Reverse
- FSUBRP—Floating-Point Subtract Reverse and Pop
- FISUBR—Floating-Point Integer Subtract Reverse

The FSUB instruction syntax has forms that include one or two explicit source operands. In the one-operand form, the instruction reads a 32-bit or 64-bit floating-point value from memory, converts it to the double-extended-precision format, subtracts it from ST(0), and writes the result to ST(0). In the two-operand form, both source operands are located in stack registers. The instruction subtracts the second operand from the first operand and writes the result to the first operand.

The FSUBP instruction syntax has forms that include zero or two explicit source operands. In the zero-operand form, the instruction subtracts ST(0) from ST(1), writes the result to ST(1), and pops the stack. In the two-operand form, both source operands are located in stack registers. The instruction subtracts the second operand from the first operand, writes the result to the first operand, and pops the stack.

The FISUB instruction reads a 16-bit or 32-bit integer value from memory, converts it to the double-extended-precision format, subtracts it from ST(0), and writes the result to ST(0).

The FSUBR and FSUBRP instructions perform the same operations as FSUB and FSUBP, respectively, except that the source operands are reversed. Instead of subtracting the second operand from the first operand, FSUBR and FSUBRP subtract the first operand from the second operand.

Multiplication.

- FMUL—Floating-Point Multiply
- FMULP—Floating-Point Multiply and Pop
- FIMUL—Floating-Point Integer Multiply

The FMUL instruction syntax has forms that include one or two explicit source operands that may be single-precision or double-precision floating-point values or 16-bit or 32-bit integer values. In the one-operand form, the instruction reads a value from memory, multiplies ST(0) by the memory operand, and writes the result to ST(0). In the two-operand form, both source operands are located in stack registers. The instruction multiplies the first operand by the second operand and writes the result to the first operand.

The FMULP instruction syntax has forms that include zero or two explicit source operands. In the zero-operand form, the instruction multiplies ST(1) by ST(0), writes the result to ST(1),

and pops the stack. In the two-operand form, both source operands are located in stack registers. The instruction multiplies the first operand by the second operand, writes the result to the first operand, and pops the stack.

The FIMUL instruction reads a 16-bit or 32-bit integer value from memory, converts it to the double-extended-precision format, multiplies ST(0) by the memory operand, and writes the result to ST(0).

Division.

- FDIV—Floating-Point Divide
- FDIVP—Floating-Point Divide and Pop
- FIDIV—Floating-Point Integer Divide
- FDIVR—Floating-Point Divide Reverse
- FDIVRP—Floating-Point Divide Reverse and Pop
- FIDIVR—Floating-Point Integer Divide Reverse

The FDIV instruction syntax has forms that include one or two source explicit operands that may be single-precision or double-precision floating-point values or 16-bit or 32-bit integer values. In the one-operand form, the instruction reads a value from memory, divides ST(0) by the memory operand, and writes the result to ST(0). In the two-operand form, both source operands are located in stack registers. The instruction divides the first operand by the second operand and writes the result to the first operand.

The FDIVP instruction syntax has forms that include zero or two explicit source operands. In the zero-operand form, the instruction divides ST(1) by ST(0), writes the result to ST(1), and pops the stack. In the two-operand form, both source operands are located in stack registers. The instruction divides the first operand by the second operand, writes the result to the first operand, and pops the stack.

The FIDIV instruction reads a 16-bit or 32-bit integer value from memory, converts it to the double-extended-precision format, divides ST(0) by the memory operand, and writes the result to ST(0).

The FDIVR and FDIVRP instructions perform the same operations as FDIV and FDIVP, respectively, except that the source operands are reversed. Instead of dividing the first

operand by the second operand, `FDIVR` and `FDIVRP` divide the second operand by the first operand.

Change Sign.

- `FABS`—Floating-Point Absolute Value
- `FCHS`—Floating-Point Change Sign

The `FABS` instruction changes the top-of-stack value, `ST(0)`, to its absolute value by clearing its sign bit to 0. The top-of-stack value is always positive following execution of the `FABS` instruction. The `FCHS` instruction complements the sign bit of `ST(0)`. For example, if `ST(0)` was `+0.0` before the execution of `FCHS`, it is changed to `-0.0`.

Round.

- `FRNDINT`—Floating-Point Round to Integer

The `FRNDINT` instruction rounds the top-of-stack value, `ST(0)`, to an integer value, although the value remains in double-extended-precision floating-point format. Rounding takes place according to the setting of the rounding control (RC) field in the x87 control word.

Partial Remainder.

- `FPREM`—Floating-Point Partial Remainder
- `FPREM1`—Floating-Point Partial Remainder

The `FPREM` instruction returns the remainder obtained by dividing `ST(0)` by `ST(1)` and stores it in `ST(0)`. If the exponent difference between `ST(0)` and `ST(1)` is less than 64, all integer bits of the quotient are calculated, guaranteeing that the remainder returned is less in magnitude than the divisor in `ST(1)`. If the exponent difference is equal to or greater than 64, only a subset of the integer quotient bits, numbering between 32 and 63, are calculated and a partial remainder is returned. `FPREM` can be repeated on a partial remainder until reduction is complete. It can be used to bring the operands of transcendental functions into their proper range. `FPREM` is supported for software written for early x87 coprocessors. Unlike the `FPREM1` instruction, `FPREM` does not calculate the partial remainder as specified in IEEE Standard 754.

The FPREM1 instruction works like FPREM, except that the FPREM1 quotient is rounded using round-to-nearest mode, whereas FPREM truncates the quotient.

Square Root.

- FSQRT—Floating-Point Square Root

The FSQRT instruction replaces the contents of the top-of-stack, ST(0), with its square root.

6.5.5 Transcendental Functions

The transcendental instructions compute trigonometric functions, inverse trigonometric functions, logarithmic functions, and exponential functions.

Trigonometric Functions.

- FSIN—Floating-Point Sine
- FCOS—Floating-Point Cosine
- FSINCOS—Floating-Point Sine and Cosine
- FPTAN—Floating-Point Partial Tangent
- FPATAN—Floating-Point Partial Arctangent

The FSIN instruction replaces the contents of the top-of-stack, ST(0), with its sine, in radians.

The FCOS instruction replaces the contents of the top-of-stack, ST(0), with its cosine, in radians.

The FSINCOS instruction computes both the sine and cosine of ST(0), in radians, and writes the sine to ST(0) and pushes the cosine onto the stack. Frequently, a piece of code that needs to compute the sine of an argument also needs to compute the cosine of that same argument. In such cases, use the FSINCOS instruction to compute both functions concurrently, which is faster than using separate FSIN and FCOS instructions.

The FPTAN instruction replaces the contents of the top-of-stack, ST(0), with its tangent, in radians, and pushes the value 1.0 onto the stack.

The FPATAN instruction computes $\theta = \arctan(Y/X)$, in which X is located in ST(0) and Y in ST(1). The result, θ , is written over Y in ST(1), and the stack is popped.

FSIN, FCOS, FSINCOS, and FPTAN are architecturally restricted in their argument range. Only arguments with a

magnitude of less than or equal to 2^{63} can be evaluated. If the argument is out of range, the C2 condition-code bit in the x87 status word is set to 1, and the argument is returned as the result. If software detects an out-of-range argument, the FPREM or FPREM1 instruction can be used to reduce the magnitude of the argument before using the FSIN, FCOS, FSINCOS, or FPTAN instruction again.

Logarithmic Functions.

- F2XM1—Floating-Point Compute $2^x - 1$
- FSCALE—Floating-Point Scale
- FYL2X—Floating-Point $y * \log_2 x$
- FYL2XP1—Floating-Point $y * \log_2(x + 1)$

The F2XM1 instruction computes $Y = 2^X - 1$. X is located in ST(0) and must fall between -1 and $+1$. Y replaces X in ST(0). If ST(0) is out of range, the instruction returns an undefined result but no x87 status-word exception bits are affected.

The FSCALE instruction replaces ST(0) with ST(0) times 2^n , where n is the value in ST(1) truncated to an integer. This provides a fast method of multiplying by integral powers of 2.

The FYL2X instruction computes $Z = Y * \log_2 X$. X is located in ST(0) and Y is located in ST(1). X must be greater than 0. The result, Z, replaces Y in ST(1), which becomes the new top-of-stack because X is popped off the stack.

The FYL2XP1 instruction computes $Z = Y * \log_2(X + 1)$. X located in ST(0) and must be in the range $0 < |X| < (1 - 2^{1/2}) / 2$. Y is taken from ST(1). The result, Z, replaces Y in ST(1), which becomes the new top-of-stack because X is popped off the stack.

Accuracy of Transcendental Results. x87 computations are carried out in double-extended-precision format, so that the transcendental functions provide results accurate to within one *unit in the last place (ulp)* for each of the floating-point data types.

Argument Reduction Using Pi. The FPREM and FPREM1 instructions can be used to reduce an argument of a trigonometric function by a multiple of Pi. The following example shows a reduction by 2π :

$$\sin(n*2\pi+x) = \sin(x) \text{ for all integral } n$$

In this example, the range is $0 \leq x < 2\pi$ in the case of FPREM or $-\pi \leq x \leq \pi$ in the case of FPREM1. Negative arguments are reduced by repeatedly subtracting -2π . See “Partial Remainder” on page 333 for details of the instructions.

6.5.6 Compare and Test

The compare-and-test instructions set and clear flags in the rFLAGS register to indicate the relationship between two operands (less, equal, greater, or unordered).

Floating-Point Ordered Compare.

- FCOM—Floating-Point Compare
- FCOMP—Floating-Point Compare and Pop
- FCOMPP—Floating-Point Compare and Pop Twice
- FCOMI—Floating-Point Compare and Set Flags
- FCOMIP—Floating-Point Compare and Set Flags and Pop

The FCOM instruction syntax has forms that include zero or one explicit source operands. In the zero-operand form, the instruction compares ST(1) with ST(0) and writes the x87 status-word condition codes accordingly. In the one-operand form, the instruction reads a 32-bit or 64-bit value from memory, compares it with ST(0), and writes the x87 condition codes accordingly.

The FCOMP instruction performs the same operation as FCOM but also pops ST(0) after writing the condition codes.

The FCOMPP instruction performs the same operation as FCOM but also pops both ST(0) and ST(1). FCOMPP can be used to initialize the x87 stack at the end of an x87 procedure by removing two registers of preloaded data from the stack.

The FCOMI instruction compares the contents of ST(0) with the contents of another stack register and writes the ZF, PF, and CF flags in the rFLAGS register as shown in Table 6-14 on page 337. If no source is specified, ST(0) is compared to ST(1). If ST(0) or the source operand is a NaN or in an unsupported format, the flags are set to indicate an unordered condition.

The FCOMIP instruction performs the same comparison as FCOMI but also pops ST(0) after writing the rFLAGS bits.

Table 6-14. rFLAGS Values for FCOMI Instruction

Flag	ST(0) > ST(i)	ST(0) < ST(i)	ST(0) = ST(i)	Unordered
ZF	0	0	1	1
PF	0	0	0	1
CF	0	1	0	1

For comparison-based branches, the combination of FCOMI and FCMOV cc is faster than the classical method of using FxSTSW AX to copy condition codes through the AX register to the rFLAGS register, where they can provide branch direction for conditional operations.

The FCOM x instructions perform ordered compares, as opposed to the FUCOM x instructions. See the description of ordered vs. unordered compares immediately below.

Floating-Point Unordered Compare.

- FUCOM—Floating-Point Unordered Compare
- FUCOMP—Floating-Point Unordered Compare and Pop
- FUCOMPP—Floating-Point Unordered Compare and Pop Twice
- FUCOMI—Floating-Point Unordered Compare and Set Flags
- FUCOMIP—Floating-Point Unordered Compare and Set Flags and Pop

The FUCOM x instructions perform the same operations as the FCOM x instructions, except that the FUCOM x instructions generate an invalid-operation exception (IE) only if any operand is an unsupported data type or a signaling NaN (SNaN), whereas the ordered-compare FCOM x instructions generate an invalid-operation exception if any operand is an unsupported data type or any type of NaN. For a description of NaNs, see “Number Representation” on page 312.

Integer Compare.

- FICOM—Floating-Point Integer Compare
- FICOMP—Floating-Point Integer Compare and Pop

The FICOM instruction reads a 16-bit or 32-bit integer value from memory, compares it with ST(0), and writes the condition codes in the same way as the FCOM instruction.

The FICOMP instruction performs the same operations as FICOM but also pops ST(0).

Test.

- FTST—Floating-Point Test with Zero

The FTST instruction compares ST(0) with zero and writes the condition codes in the same way as the FCOM instruction.

Classify.

- FXAM—Floating-Point Examine

The FXAM instruction determines the type of value in ST(0) and sets the condition codes accordingly, as shown in Table 6-15 on page 339.

Table 6-15. Condition-Code Settings for FXAM

C3	C2	C0	C1 ¹	Meaning
0	0	0	0	+unsupported
0	0	0	1	-unsupported
0	0	1	0	+NaN
0	0	1	1	-NaN
0	1	0	0	+normal
0	1	0	1	-normal
0	1	1	0	+infinity
0	1	1	1	-infinity
1	0	0	0	+0
1	0	0	1	-0
1	0	1	0	+empty
1	0	1	1	-empty
1	1	0	0	+denormal
1	1	0	1	-denormal

Note:
1. C1 is the sign of ST(0).

6.5.7 Stack Management

The stack management instructions move the x87 top-of-stack pointer (TOP) and clear the contents of stack registers.

Stack Control.

- FDECSTP—Floating-Point Decrement Stack-Top Pointer
- FINCSTP—Floating-Point Increment Stack-Top Pointer

The FINCSTP and FDECSTP instructions increment and decrement, respectively, the TOP, modulo-8. Neither the x87 tag word nor the contents of the floating-point stack itself is updated.

Clear State.

- FFREE—Free Floating-Point Register

The FFREE instruction frees a specified stack register by setting the x87 tag-word bits for the register to all 1s, indicating *empty*. Neither the stack-register contents nor the stack pointer is modified by this instruction.

6.5.8 No Operation

This instruction uses processor cycles but generates no result.

- FNOP—Floating-Point No Operation

The FNOP instruction has no operands and writes no result. Its purpose is simply to delay execution of a sequence of instructions.

6.5.9 Control

The control instructions are used to initialize, save, and restore x87 processor state and to manage x87 exceptions.

Initialize.

- FINIT—Floating-Point Initialize
- FNINIT—Floating-Point No-Wait Initialize

The FINIT and FNINIT instructions set all bits in the x87 control-word, status-word, and tag word registers to their default values. Assemblers issue FINIT as an FWAIT instruction followed by an FNINIT instruction. Thus, FINIT (but not FNINIT) reports pending unmasked x87 floating-point exceptions before performing the initialization.

Both FINIT and FNINIT write the control word with its initialization value, 037Fh, which specifies round-to-nearest, all exceptions masked, and double-extended-precision. The tag word indicates that the floating-point registers are *empty*. The status word and the four condition-code bits are cleared to 0. The x87 pointers and opcode state (“Pointers and Opcode State” on page 305) are all cleared to 0.

The FINIT instruction should be used when pending x87 floating-point exceptions are being reported (unmasked). The no-wait instruction, FNINIT, should be used when pending x87 floating-point exceptions are not being reported (masked).

Wait for Exceptions.

- FWAIT or WAIT—Wait for Unmasked x87 Floating-Point Exceptions

The FWAIT and WAIT instructions are synonyms. The instruction forces the processor to test for and handle any pending, unmasked x87 floating-point exceptions.

Clear Exceptions.

- FCLEX—Floating-Point Clear Flags
- FNCLEX—Floating-Point No-Wait Clear Flags

These instructions clear the status-word exception flags, stack-fault flag, and busy flag. They leave the four condition-code bits undefined.

Assemblers issue FCLEX as an FWAIT instruction followed by an FNCLEX instruction. Thus, FCLEX (but not FNCLEX) reports pending unmasked x87 floating-point exceptions before clearing the exception flags.

The FCLEX instruction should be used when pending x87 floating-point exceptions are being reported (unmasked). The no-wait instruction, FNCLEX, should be used when pending x87 floating-point exceptions are not being reported (masked).

Save and Restore x87 Control Word.

- FLDCW—Floating-Point Load x87 Control Word
- FSTCW—Floating-Point Store Control Word
- FNSTCW—Floating-Point No-Wait Store Control Word

These instructions load or store the x87 control-word register as a 2-byte value from or to a memory location.

The FLDCW instruction loads a control word. If the loaded control word unmask any pending x87 floating-point exceptions, these exceptions are reported when the next non-control x87 or 64-bit media instruction is executed.

Assemblers issue FSTCW as an FWAIT instruction followed by an FNSTCW instruction. Thus, FSTCW (but not FNSTCW) reports pending unmasked x87 floating-point exceptions before storing the control word.

The FSTCW instruction should be used when pending x87 floating-point exceptions are being reported (unmasked). The no-wait instruction, FNSTCW, should be used when pending x87 floating-point exceptions are not being reported (masked).

Save x87 Status Word.

- FSTSW—Floating-Point Store Status Word
- FNSTSW—Floating-Point No-Wait Store Status Word

These instructions store the x87 status word either at a specified 2-byte memory location or in the AX register. The second form, `FxSTSW AX`, is used in older code to copy condition codes through the AX register to the rFLAGS register, where they can be used for conditional branching using general-purpose instructions. However, the combination of `FCOMI` and `FCMOVcc` provides a faster method of conditional branching.

Assemblers issue FSTSW as an FWAIT instruction followed by an FNSTSW instruction. Thus, FSTSW (but not FNSTSW) reports pending unmasked x87 floating-point exceptions before storing the status word.

The FSTSW instruction should be used when pending x87 floating-point exceptions are being reported (unmasked). The no-wait instruction, FNSTSW, should be used when pending x87 floating-point exceptions are not being reported (masked).

Save and Restore x87 Environment.

- FLDENV—Floating-Point Load x87 Environment
- FNSTENV—Floating-Point No-Wait Store Environment
- FSTENV—Floating-Point Store Environment

These instructions load or store the entire x87 environment (non-data processor state) as a 14-byte or 28-byte block, depending on effective operand size, from or to memory.

When executing FLDENV, any exception flags are set in the new status word, and these exceptions are unmasked in the control word, a floating-point exception occurs when the next non-control x87 or 64-bit media instruction is executed.

Assemblers issue FSTENV as an FWAIT instruction followed by an FNSTENV instruction. Thus, FSTENV (but not FNSTENV) reports pending unmasked x87 floating-point exceptions before storing the status word.

The x87 environment includes the x87 control word register, x87 status word register, x87 tag word, last x87 instruction pointer, last x87 data pointer, and last x87 opcode. See “Media and x87

Processor State” in Volume 2 for details on how the x87 environment is stored in memory.

Save and Restore x87 and 64-Bit Media State.

- FSAVE—Save x87 and MMX State.
- FNSAVE—Save No-Wait x87 and MMX State.
- FRSTOR—Restore x87 and MMX State.

These instructions save and restore the entire processor state for x87 floating-point instructions and 64-bit media instructions. The instructions save and restore either 94 or 108 bytes of data, depending on the effective operand size.

Assemblers issue FSAVE as an FWAIT instruction followed by an FNSAVE instruction. Thus, FSAVE (but not FNSAVE) reports pending unmasked x87 floating-point exceptions before saving the state.

After saving the state, the processor initializes the x87 state by performing the equivalent of an FINIT instruction. For details, see “State-Saving” on page 360.

Save and Restore x87, 128-Bit, and 64-Bit State.

- FXSAVE—Save XMM, MMX, and x87 State.
- FXRSTOR—Restore XMM, MMX, and x87 State.

The FXSAVE and FXRSTOR instructions save and restore the entire 512-byte processor state for 128-bit media instructions, 64-bit media instructions, and x87 floating-point instructions. The architecture supports two memory formats for FXSAVE and FXRSTOR, a 512-byte 32-bit legacy format and a 512-byte 64-bit format. Selection of the 32-bit or 64-bit format is determined by the effective operand size for the FXSAVE and FXRSTOR instructions. For details, see “Saving Media and x87 Processor State” in Volume 2.

FXSAVE and FXRSTOR execute faster than FSAVE/FNSAVE and FRSTOR. However, unlike FSAVE and FNSAVE, FXSAVE does not initialize the x87 state, and like FNSAVE it does not report pending unmasked x87 floating-point exceptions. For details, see “State-Saving” on page 360.

6.6 Instruction Effects on rFLAGS

The rFLAGS register is described in “Flags Register” on page 38. Table 6-16 summarizes the effect that x87 floating-point instructions have on individual flags within the rFLAGS register. Only instructions that access the rFLAGS register are shown—all other x87 instructions have no effect on rFLAGS.

The following codes are used within the table:

- Mod—The flag is modified.
- Tst—The flag is tested.
- Gray shaded cells indicate the flag is not affected by the instruction.

Table 6-16. Instruction Effects on rFLAGS

Instruction Mnemonic	rFLAGS Mnemonic and Bit Number										
	RF 16	NT 14	OF 11	DF 10	IF 9	TF 8	SF 7	ZF 6	AF 4	PF 2	CF 0
FCMOVcc								Tst		Tst	Tst
FCOMI FCOMIP FUCOMI FUCOMIP								Mod		Mod	Mod

6.7 Instruction Prefixes

Instruction prefixes, in general, are described in “Instruction Prefixes” on page 87. The following restrictions apply to the use of instruction prefixes with x87 instructions.

Supported Prefixes. The following prefixes can be used with x87 instructions:

- *Operand-Size Override*—The 66h prefix affects only the FLDENV, FSTENV, FNSTENV, FSAVE, FNSAVE, and FRSTOR instructions, in which it selects between a 16-bit and 32-bit memory-image format. The prefix is ignored by all other x87 instructions.
- *Address-Size Override*—The 67h prefix affects only operands in memory, in which it selects between a 16-bit and 32-bit addresses. The prefix is ignored by all other x87 instructions.

- **Segment Overrides**—The 2Eh (CS), 36h (SS), 3Eh (DS), 26h (ES), 64h (FS), and 65h (GS) prefixes specify a segment. They affect only operands in memory. In 64-bit mode, the CS, DS, ES, SS segment overrides are ignored.
- **REX**—The REX prefix affects only the FXSAVE and FXRSTOR instructions, in which it selects between two types of 512-byte memory-image format, as described in “Saving Media and x87 Processor State” in Volume 2. The prefix is ignored by all other x87 instructions.

Ignored Prefixes. The following prefixes are ignored by x87 instructions:

- **REP**—The F3h and F2h prefixes.

Prefixes That Cause Exceptions. The following prefixes cause an exception:

- **LOCK**—The F0h prefix causes an invalid-opcode exception when used with x87 instructions.

6.8 Feature Detection

Before executing x87 floating-point instructions, software should determine if the processor supports the technology by executing the CUID instruction. “Feature Detection” on page 92 describes how software uses the CUID instruction to detect feature support. For full support of the x87 floating-point features, the following feature must be present:

- **On-Chip Floating-Point Unit**, indicated by bit 0 of CUID standard function 1 and CUID extended function 8000_0001h.
- **CMOV_{cc}** (conditional moves), indicated by bit 15 of CUID standard function 1 and CUID extended function 8000_0001h. This bit indicates support for x87 floating-point conditional moves (FCMOV_{cc}) whenever the On-Chip Floating-Point Unit bit (bit 0) is also set.

Software may also wish to check for the following support, because the FXSAVE and FXRSTOR instructions execute faster than FSAVE and FRSTOR:

- **FXSAVE and FXRSTOR**, indicated by bit 24 of CUID standard function 1 and extended function 8000_0001h.

Software that runs in long mode should also check for the following support:

- Long Mode, indicated by bit 29 of CPUID extended function 8000_0001h.

See “Processor Feature Identification” in Volume 2 for a full description of the CPUID instruction and its function codes.

6.9 Exceptions

Types of Exceptions. x87 instructions can generate two types of exceptions:

- *General-Purpose Exceptions*, described below in “General-Purpose Exceptions”
- *x87 Floating-Point Exceptions (#MF)*, described in “x87 Floating-Point Exception Causes” on page 347

Relation to 128-Bit Media Exceptions. Although the x87 floating-point instructions and the 128-bit media instructions each have certain exceptions with the same names, the exception-reporting and exception-handling methods used by the two instruction subsets are distinct and independent of each other. If procedures using both types of instructions are run in the same operating environment, separate services routines should be provided for the exceptions of each type of instruction subset.

6.9.1 General-Purpose Exceptions

The sections below list general-purpose exceptions generated and not generated by x87 floating-point instructions. For a summary of the general-purpose exception mechanism, see “Interrupts and Exceptions” on page 106. For details about each exception and its potential causes, see “Exceptions and Interrupts” in Volume 2.

Exceptions Generated. x87 instructions can generate the following general-purpose exceptions:

- #DB—Debug Exception (Vector 1)
- #BP—Breakpoint Exception (Vector 3)
- #UD—Invalid-Opcode Exception (Vector 6)
- #NM—Device-Not-Available Exception (Vector 7)
- #DF—Double-Fault Exception (Vector 8)

- #SS—Stack Exception (Vector 12)
- #GP—General-Protection Exception (Vector 13)
- #PF—Page-Fault Exception (Vector 14)
- #MF—x87 Floating-Point Exception-Pending (Vector 16)
- #AC—Alignment-Check Exception (Vector 17)
- #MC—Machine-Check Exception (Vector 18)

For details on #MF exceptions, see “x87 Floating-Point Exception Causes” below.

Exceptions Not Generated. x87 instructions do not generate the following general-purpose exceptions:

- #DE—Divide-by-zero-error exception (Vector 0)
- Non-Maskable-Interrupt Exception (Vector 2)
- #OF—Overflow exception (Vector 4)
- #BR—Bound-range exception (Vector 5)
- Coprocessor-segment-overflow exception (Vector 9)
- #TS—Invalid-TSS exception (Vector 10)
- #NP—Segment-not-present exception (Vector 11)
- #MC—Machine-check exception (Vector 18)
- #XF—SIMD floating-point exception (Vector 19)

For details on all general-purpose exceptions, see “Exceptions and Interrupts” in Volume 2.

6.9.2 x87 Floating-Point Exception Causes

The x87 floating-point exception-pending (#MF) exception listed above in “General-Purpose Exceptions” is actually the logical OR of six exceptions that can be caused by x87 floating-point instructions. Each of the six exceptions has a status flag in the x87 status word and a mask bit in the x87 control word. A seventh exception, stack fault (SF), is reported together with one of the six maskable exceptions and does not have a mask bit.

If a #MF exception occurs when its mask bit is set to 1 (*masked*), the processor responds in a default way that does not invoke the #MF exception service routine. If an exception occurs when its mask bit is cleared to 0 (*unmasked*), the processor suspends processing of the faulting instruction (if possible) and, at the boundary of the next non-control x87 or 64-bit media instruction (see “Control” on page 340), determines that an

unmasked exception is pending—by checking the exception status (ES) flag in the x87 status word—and invokes the #MF exception service routine.

#MF Exception Types and Flags. The #MF exceptions are of six types, five of which are mandated by the IEEE 754 standard. These six types and their bit-flags in the x87 status word are shown in Table 6-17. A stack fault (SF) exception is always accompanied by an invalid-operation exception (IE). A summary of each exception type is given in “x87 Status Word Register (FSW)” on page 297.

Table 6-17. x87 Floating-Point (#MF) Exception Flags

Exception and Mnemonic	x87 Status-Word Bit ¹	Comparable IEEE 754 Exception
Invalid-operation exception (IE)	0	Invalid Operation
Invalid-operation exception (IE) with stack fault (SF) exception	0 and 6	<i>none</i>
Denormalized-operand exception (DE)	1	<i>none</i>
Zero-divide exception (ZE)	2	Division by Zero
Overflow exception (OE)	3	Overflow
Underflow exception (UE)	4	Underflow
Precision exception (PE)	5	Inexact
Note:		
1. See “x87 Status Word Register (FSW)” on page 297 for a summary of each exception.		

The sections below describe the causes for the #MF exceptions. Masked and unmasked responses to the exceptions are described in “x87 Floating-Point Exception Masking” on page 353. The priority of #MF exceptions are described in “x87 Floating-Point Exception Priority” on page 351.

Invalid-Operation Exception (IE). The IE exception occurs due to one of the attempted operations shown in Table 6-18 on page 349. An IE exception may also be accompanied by a stack fault (SF) exception. See “Stack Fault (SF)” on page 350.

Table 6-18. Invalid-Operation Exception (IE) Causes

Operation		Condition
Arithmetic (IE exception)	Any Arithmetic Operation	<ul style="list-style-type: none"> A source operand is an SNaN, or A source operand is an unsupported data type (pseudo-NaN, pseudo-infinity, pseudo-denormal, or unnormal).
	FADD, FADDP	Source operands are infinities with opposite signs.
	FSUB, FSUBP, FSUBR, FSUBRP	Source operands are infinities with same sign.
	FMUL, FMULP	Source operands are zero and infinity.
	FDIV, FDIVP, FDIVR, FDIVRP	Source operands are both infinities or both zeros.
	FSQRT	Source operand is less than zero (except ± 0 which returns ± 0).
	FYL2X	Source operand is less than zero (except ± 0 which returns $\pm \infty$).
	FYL2XP1	Source operand is less than minus one.
	FCOS, FPTAN, FSIN, FSINCOS	Source operand is infinity.
	FCOM, FCOMP, FCOMPP, FCOMI, FCOMIP	A source operand is a QNaN.
	FPREM, FPREM1	Dividend is infinity or divisor is zero.
	FIST, FISTP, FISTTP	Source operand overflows the destination size.
	FBSTP	Source operand overflows packed BCD data size.
Stack (IE and SF exceptions)	Stack overflow or underflow. ¹	
Note: 1. The processor sets condition code $CI = 1$ for overflow, $CI = 0$ for underflow.		

Denormalized-Operand Exception (DE). The DE exception occurs in any of the following cases:

- *Denormalized Operand (any precision)*—An arithmetic instruction uses an operand of any precision that is in denormalized form, as described in “Denormalized (Tiny) Numbers” on page 314.
- *Denormalized Single-Precision or Double-Precision Load*—An instruction loads a single-precision or double-precision (but

not double-extended-precision) operand, which is in denormalized form, into an x87 register.

Zero-Divide Exception (ZE). The ZE exception occurs when:

- *Divisor is Zero*—An FDIV, FDIVP, FDIVR, FDIVRP, FIDIV, or FIDIVR instruction attempts to divide zero into a non-zero finite dividend.
- *Source Operand is Zero*—An FYL2X or FXTRACT instruction uses a source operand that is zero.

Overflow Exception (OE). The OE exception occurs when the value of a rounded floating-point result is larger than the largest representable normalized positive or negative floating-point number in the destination format, as shown in Table 6-5 on page 311. An overflow can occur through computation or through conversion of higher-precision numbers to lower-precision numbers. See “Precision” on page 321. Integer and BCD overflow is reported via the invalid-operation exception.

Underflow Exception (UE). The UE exception occurs when the value of a rounded, non-zero floating-point result is too small to be represented as a normalized positive or negative floating-point number in the destination format, as shown in Table 6-5 on page 311. Integer and BCD underflow is reported via the invalid-operation exception.

Precision Exception (PE). The PE exception, also called the *inexact-result* exception, occurs when a floating-point result, after rounding, differs from the infinitely precise result and thus cannot be represented exactly in the specified destination format. Software that does not require exact results normally masks this exception. See “Precision” on page 321 and “Rounding” on page 322.

Stack Fault (SF). The SF exception occurs when a stack overflow (due to a push or load into a non-empty stack register) or stack underflow (due to referencing an empty stack register) occurs in the x87 stack-register file. The empty and non-empty conditions are shown in Table 6-3 on page 304. When either of these conditions occur, the processor also sets the invalid-operation exception (IE) flag, and it sets or clears the condition-code 1 (C1) bit to indicate the direction of the stack fault (C1 = 1 for overflow, C1 = 0 for underflow). Unlike the flags for

the other x87 exceptions, the SF flag does not have a corresponding mask bit in the x87 control word.

6.9.3 x87 Floating-Point Exception Priority

Table 6-19 shows the priority with which the processor recognizes multiple, simultaneous SIMD floating-point exceptions and operations involving QNaN operands. Each exception type is characterized by its timing, as follows:

- *Pre-Computation*—an exception that is recognized before an instruction begins its operation.
- *Post-Computation*—an exception that is recognized after an instruction completes its operation.

For post-computation exceptions, a result may be written to the destination, depending on the type of exception and whether the destination is a register or memory location. Operations involving QNaNs do not necessarily cause exceptions, but the processor handles them with the priority shown in Table 6-19 on page 352 relative to the handling of exceptions.

Table 6-19. Priority of x87 Floating-Point Exceptions

Priority	Exception or Operation	Timing
1	Invalid-operation exception (IE) with stack fault (SF) due to underflow	Pre-Computation
2	Invalid-operation exception (IE) with stack fault (SF) due to overflow	Pre-Computation
3	Invalid-operation exception (IE) when accessing unsupported data type	Pre-Computation
4	Invalid-operation exception (IE) when accessing SNaN operand	Pre-Computation
5	Operation involving a QNaN operand ¹	—
6	Any other type of invalid-operation exception (IE)	Pre-Computation
	Zero-divide exception (ZE)	Pre-Computation
7	Denormalized operation exception (DE)	Pre-Computation
8	Overflow exception (OE)	Post-Computation
	Underflow exception (UE)	Post-Computation
9	Precision (inexact) exception (PE)	Post-Computation
Note:		
1. Operations involving QNaN operands do not, in themselves, cause exceptions but they are handled with this priority relative to the handling of exceptions.		

For exceptions that occur before the associated operation (pre-operation, as shown in Table 6-19), if an unmasked exception occurs, the processor suspends processing of the faulting instruction but it waits until the boundary of the next non-control x87 or 64-bit media instruction to be executed before invoking the associated exception service routine. During this delay, non-x87 instructions may overwrite the faulting x87 instruction's source or destination operands in memory. If that occurs, the x87 service routine may be unable to perform its job.

To prevent such problems, analyze x87 procedures for potential exception-causing situations and insert a WAIT or other safe x87 instruction immediately after any x87 instruction that may cause a problem.

6.9.4 x87 Floating-Point Exception Masking

The six floating-point exception flags in the x87 status word have corresponding exception-flag masks in the x87 control word, as shown in Table 6-20.

Table 6-20. x87 Floating-Point (#MF) Exception Masks

Exception Mask and Mnemonic	x87 Control-Word Bit ¹
Invalid-operation exception mask (IM)	0
Denormalized-operand exception mask (DM)	1
Zero-divide exception mask (ZM)	2
Overflow exception mask (OM)	3
Underflow exception mask (UM)	4
Precision exception mask (PM)	5
Note:	
1. See "x87 Status Word Register (FSW)" on page 297 for a summary of each exception.	

Each mask bit, when set to 1, inhibits invocation of the #MF exception handler and instead continues normal execution using the default response for the exception type. During initialization with FINIT or FNINIT, all exception-mask bits in the x87 control word are set to 1 (masked). At processor reset, all exception-mask bits are cleared to 0 (unmasked).

Masked Responses. The occurrence of a masked exception does not invoke its exception handler when the exception condition occurs. Instead, the processor handles masked exceptions in a default way, as shown in Table 6-21 on page 354.

Table 6-21. Masked Responses to x87 Floating-Point Exceptions

Exception and Mnemonic	Type of Operation ¹	Processor Response
Invalid-operation exception (IE)²	Any Arithmetic Operation: Source operand is an SNaN.	Set IE flag, and return a QNaN value.
	Any Arithmetic Operation: Source operand is an unsupported data type or FADD, FADDP: Source operands are infinities with opposite signs or FSUB, FSUBP, FSUBR, FSUBRP: Source operands are infinities with same sign or FMUL, FMULP: Source operands include zero and infinity or FDIV, FDIVP, FDIVR, FDIVRP: Source operands are both infinities or both are zeros or FSQRT: Source operand is less than zero (except ± 0 which returns ± 0) or FYL2X: Source operand is less than zero (except ± 0 which returns $\pm \infty$) or FYL2XP1: Source operand is less than minus one.	Set IE flag, and return the floating-point indefinite value ³ .
Notes: <ol style="list-style-type: none"> 1. See "Instruction Summary" on page 323 for the types of instructions. 2. Includes invalid-operation exception (IE) together with stack fault (SF). 3. See "Indefinite Values" on page 319. 		

Table 6-21. Masked Responses to x87 Floating-Point Exceptions (continued)

Exception and Mnemonic	Type of Operation ¹	Processor Response
Invalid-operation exception (IE)²	FCOS, FPTAN, FSIN, FSINCOS: Source operand is ∞ or FPREM, FPREM1: Dividend is infinity or divisor is 0.	Set IE flag, return the floating-point indefinite value ³ , and clear condition code C2 to 0.
	FCOM, FCOMP, or FCOMPP: One or both operands is a NaN or FUCOM, FUCOMP, or FUCOMPP: One or both operands is an SNaN.	Set IE flag, and set C3–C0 condition codes to reflect the result.
	FCOMI or FCOMIP: One or both operands is a NaN or FUCOMI or FUCOMIP: One or both operands is an SNaN.	Set IE flag, and writes the zero (ZF), parity (PF), and carry (CF) flags in rFLAGS according to the result.
	FIST, FISTP, FISTTP: Source operand overflows the destination size.	Set IE flag, and return the integer indefinite value ³ .
	FXCH: A source register is specified <i>empty</i> by its tag bits.	Set IE flag, and perform exchange using floating-point indefinite value ³ as content for empty register(s).
	FBSTP: Source operand overflows packed BCD data size.	Set IE flag, and return the packed-decimal indefinite value ³ .
Denormalized-operand exception (DE)		Set DE flag, and return the result using the denormal operand(s).
Notes: <ol style="list-style-type: none"> 1. See "Instruction Summary" on page 323 for the types of instructions. 2. Includes invalid-operation exception (IE) together with stack fault (SF). 3. See "Indefinite Values" on page 319. 		

Table 6-21. Masked Responses to x87 Floating-Point Exceptions (continued)

Exception and Mnemonic	Type of Operation ¹	Processor Response
Zero-divide exception (ZE)	FDIV, FDIVP, FDIVR, FDIVRP, FIDIV, or FIDIVR: Divisor is 0.	Set ZE flag, and return signed ∞ with sign bit = XOR of the operand sign bits.
	FYL2X: ST(0) is 0 and ST(1) is a non-zero floating-point value.	Set ZE flag, and return signed ∞ with sign bit = complement of sign bit for ST(1) operand.
	FEXTRACT: Source operand is 0.	Set ZE flag, write ST(0) = 0 with sign of operand, and write ST(1) = $-\infty$.
Overflow exception (OE)	Round to nearest.	<ul style="list-style-type: none"> • If sign of result is positive, set OE flag, and return $+\infty$. • If sign of result is negative, set OE flag, and return $-\infty$.
	Round toward $+\infty$.	<ul style="list-style-type: none"> • If sign of result is positive, set OE flag, and return $+\infty$. • If sign of result is negative, set OE flag, and return finite negative number with largest magnitude.
	Round toward $-\infty$.	<ul style="list-style-type: none"> • If sign of result is positive, set OE flag, and return finite positive number with largest magnitude. • If sign of result is negative, set OE flag, and return $-\infty$.
	Round toward 0.	<ul style="list-style-type: none"> • If sign of result is positive, set OE flag and return finite positive number with largest magnitude. • If sign of result is negative, set OE flag and return finite negative number with largest magnitude.
Underflow exception (UE)		<ul style="list-style-type: none"> • If result is both denormal (tiny) and inexact, set UE flag and return denormalized result. • If result is denormal (tiny) but not inexact, return denormalized result but do not set UE flag.
Notes: <ol style="list-style-type: none"> 1. See "Instruction Summary" on page 323 for the types of instructions. 2. Includes invalid-operation exception (IE) together with stack fault (SF). 3. See "Indefinite Values" on page 319. 		

Table 6-21. Masked Responses to x87 Floating-Point Exceptions (continued)

Exception and Mnemonic	Type of Operation ¹	Processor Response
Precision exception (PE)	Without overflow or underflow	Set PE flag, return rounded result, write C1 condition code to specify round-up (C1 = 1) or not round-down (C1 = 0).
	With masked overflow or underflow	Set PE flag and respond as for the OE or UE exceptions.
	With unmasked overflow or underflow for register destination	Set PE flag, respond as for the OE or UE exception, and call OE or UE service routine.
	With unmasked overflow or underflow for memory destination	Ignore PE exception, and assert FERR# as for an unmasked exception. The destination and the TOP are not changed.
Notes: <ol style="list-style-type: none"> 1. See "Instruction Summary" on page 323 for the types of instructions. 2. Includes invalid-operation exception (IE) together with stack fault (SF). 3. See "Indefinite Values" on page 319. 		

Unmasked Responses. The processor handles unmasked exceptions as shown in Table 6-22.

Table 6-22. Unmasked Responses to x87 Floating-Point Exceptions

Exception and Mnemonic	Type of Operation	Processor Response ¹
Invalid-operation exception (IE)		Set IE and ES flags, and call the #MF service routine. The destination and the TOP are not changed.
Invalid-operation exception (IE) with stack fault (SF)		
Denormalized-operand exception (DE)		Set DE and ES flags, and call the #MF service routine. The destination and the TOP are not changed.
Zero-divide exception (ZE)		Set ZE and ES flags, and call the #MF service routine. The destination and the TOP are not changed.
Note: <ol style="list-style-type: none"> 1. For all unmasked exceptions, the processor's response also includes assertion of the FERR# output signal at the completion of the instruction that caused the exception. 		

Table 6-22. Unmasked Responses to x87 Floating-Point Exceptions (continued)

Exception and Mnemonic	Type of Operation	Processor Response ¹
Overflow exception (OE)		<ul style="list-style-type: none"> • If the destination is memory, set OE and ES flags, and call the #MF service routine. The destination and the TOP are not changed. • If the destination is an x87 register: <ul style="list-style-type: none"> - divide true result by 2^{24576}, - round significand according to PC precision control and RC rounding control (or round to double-extended precision for instructions not observing PC precision control), - write C1 condition code according to rounding (C1 = 1 for round up, C1 = 0 for round toward zero), - write result to destination, - pop or push stack if specified by the instruction, - set OE and ES flags, and call the #MF service routine.
Underflow exception (UE)		<ul style="list-style-type: none"> • If the destination is memory, set UE and ES flags, and call the #MF service routine. The destination and the TOP are not changed. • If the destination is an x87 register: <ul style="list-style-type: none"> - multiply true result by 2^{24576}, - round significand according to PC precision control and RC rounding control (or round to double-extended precision for instructions not observing PC precision control), - write C1 condition code according to rounding (C1 = 1 for round up, C1 = 0 for round toward zero), - write result to destination, - pop or push stack if specified by the instruction, - set UE and ES flags, and call the #MF service routine.
<p>Note:</p> <ol style="list-style-type: none"> 1. For all unmasked exceptions, the processor's response also includes assertion of the FERR# output signal at the completion of the instruction that caused the exception. 		

Table 6-22. Unmasked Responses to x87 Floating-Point Exceptions (continued)

Exception and Mnemonic	Type of Operation	Processor Response ¹
Precision exception (PE)	Without overflow or underflow	Set PE and ES flags, return rounded result, write C1 condition code to specify round-up (C1 = 1) or not round-down (C1 = 0), and call the #MF service routine.
	With masked overflow or underflow	Set PE and ES flags, respond as for the OE or UE exception, and call the #MF service routine.
	With unmasked overflow or underflow for register destination	
	With unmasked overflow or underflow for memory destination	Do not set PE flag, and set ES flag. The destination and the TOP are not changed.

Note:

- For all unmasked exceptions, the processor's response also includes assertion of the FERR# output signal at the completion of the instruction that caused the exception.

FERR# and IGNNE# Signals. In all unmasked-exception responses, the processor also asserts the FERR# output signal at the completion of the instruction that caused the exception. The exception is serviced at the boundary of the next non-control x87 or 64-bit media instruction following the instruction that caused the exception. (See “Control” on page 340 for a definition of *control instructions*.)

System software controls x87 floating-point exception reporting using the numeric error (NE) bit in control register 0 (CR0), as follows:

- If CR0.NE = 1, internal processor control over x87 floating-point exception reporting is enabled. In this case, an #MF exception occurs when the FERR# output signal is asserted. It is recommended that system software set NE to 1. This enables optimal performance in handling x87 floating-point exceptions.
- If CR0.NE = 0, internal processor control of x87 floating-point exceptions is disabled and the external IGNNE# input signal controls whether x87 floating-point exceptions are ignored, as follows:
 - When IGNNE# is 1, x87 floating-point exceptions are ignored.

- When IGNNE# is 0, x87 floating-point exceptions are reported by setting the FERR# input signal to 1. External logic can use the FERR# signal as an external interrupt.

Using NaNs in IE Diagnostic Exceptions. Both SNaNs and QNaNs can be encoded with many different values to carry diagnostic information. By means of appropriate masking and unmasking of the invalid-operation exception (IE), software can use signaling NaNs to invoke an exception handler. Within the constraints imposed by the encoding of SNaNs and QNaNs, software may freely assign the bits in the significand of a NaN. See the section “Not a Number (NaN)” on page 315 for format details.

For example, software can pre-load each element of an array with a signaling NaN that encodes the array index. When an application accesses an uninitialized array element, the invalid-operation exception is invoked and the service routine can identify that element. A service routine can store debug information in memory as the exceptions occur. The routine can create a QNaN that references its associated debug area in memory. As the program runs, the service routine can create a different QNaN for each error condition, so that a single test-run can identify a collection of errors.

6.10 State-Saving

In general, system software should save and restore x87 state between task switches or other interventions in the execution of x87 floating-point procedures. Virtually all modern operating systems running on x86 processors—like Windows NT®, UNIX, and OS/2—are preemptive multitasking operating systems that handle such saving and restoring of state properly across task switches, independently of hardware task-switch support. However, application procedures are also free to save and restore x87 state at any time they deem useful.

6.10.1 State-Saving Instructions

FSAVE/FNSAVE and FRSTOR Instructions. Application software can save and restore the x87 state by executing the FSAVE (or FNSAVE) and FRSTOR instructions. Alternatively, software may use multiple FxSTx (floating-point store stack top) instructions for saving only the contents of the x87 data registers, rather than the complete x87 state.

The FSAVE instruction stores the state, but only after handling any pending unmasked x87 floating-point exceptions, whereas the FNSAVE instruction skips the handling of these exceptions. The state of all x87 data registers is saved, as well as all x87 environment state (the x87 control word register, status word register, tag word, instruction pointer, data pointer, and last opcode register). After saving this state, the tag bits for all x87 registers are changed to *empty* and thus available for a new procedure.

FXSAVE and FXRSTOR Instructions. Application software can save and restore the 128-bit media state, 64-bit media state, and x87 floating-point state by executing the FXSAVE and FXRSTOR instructions. The FXSAVE and FXRSTOR instructions execute faster than FSAVE/FNSAVE and FRSTOR because they do not save and restore the x87 pointers (last instruction pointer, last data pointer, and last opcode, described in “Pointers and Opcode State” on page 305) except in the relatively rare cases in which the exception-summary (ES) bit in the x87 status word (the ES register image for FXSAVE, or the ES memory image for FXRSTOR) is set to 1, indicating that an unmasked x87 exception has occurred.

Unlike FSAVE and FNSAVE, however, FXSAVE does not alter the tag bits. The state of the saved x87 data registers is retained, thus indicating that the registers may still be valid (or whatever other value the tag bits indicated prior to the save). To invalidate the contents of the x87 data registers after FXSAVE, software must explicitly execute a FINIT instruction. Also, FXSAVE (like FNSAVE) and FXRSTOR do not check for pending unmasked x87 floating-point exceptions. An FWAIT instruction can be used for this purpose.

The architecture supports two memory formats for FXSAVE and FXRSTOR, a 512-byte 32-bit legacy format and a 512-byte 64-bit format, used in 64-bit mode. Selection of the 32-bit or 64-bit format is determined by the effective operand size for the FXSAVE and FXRSTOR instructions. For details, see “Saving Media and x87 Processor State” in Volume 2.

6.11 Performance Considerations

In addition to typical code optimization techniques, such as those affecting loops and the inlining of function calls, the

following considerations may help improve the performance of application programs written with x87 floating-point instructions.

These are implementation-independent performance considerations. Other considerations depend on the hardware implementation. For information about such implementation-dependent considerations and for more information about application performance in general, see the data sheets and the software-optimization guides relating to particular hardware implementations.

6.11.1 Replace x87 Code with 128-Bit Media Code

Code written with 128-bit media floating-point instructions can operate in parallel on four times as many single-precision floating-point operands as can x87 floating-point code. This achieves potentially four times the computational work of x87 instructions that use single-precision operands. Also, the higher density of 128-bit media floating-point operands may make it possible to remove local temporary variables that would otherwise be needed in x87 floating-point code. 128-bit media code is easier to write than x87 floating-point code, because the XMM register file is flat rather than stack-oriented, and, in 64-bit mode there are twice the number of XMM registers as x87 registers.

6.11.2 Use FCOMI-FCMOVx Branching

Depending on the hardware implementation of the architecture, the combination of FCOMI and FCMOV_{cc} is often faster than the classical approach using FxSTSW AX instructions for comparison-based branches that depend on the condition codes for branch direction, because FNSTSW AX is often a serializing instruction.

6.11.3 Use FSINCOS Instead of FSIN and FCOS

Frequently, a piece of code that needs to compute the sine of an argument also needs to compute the cosine of that same argument. In such cases, use the FSINCOS instruction to compute both trigonometric functions concurrently, which is faster than using separate FSIN and FCOS instructions to accomplish the same task.

6.11.4 Break Up Dependency Chains

Parallelism can be increased by breaking up dependency chains or by evaluating multiple dependency chains simultaneously (explicitly switching execution between them). Depending on the hardware implementation of the architecture, the FXCH instruction may prove faster than FST/FLD pairs for switching execution between dependency chains.

Index

Symbols

#AC exception	108
#BP exception	107
#BR exception	108
#DB exception	107
#DE exception	107
#DF exception	108
#GP exception	108
#MC exception	108
#MF exception	108, 282, 298
#NM exception	108
#NP exception	108
#OF exception	108
#PF exception	108
#SS exception	108
#TS exception	108
#UD exception	108, 218
#XF exception	108, 218

Numerics

128-bit media programming.....	129
16-bit mode.....	xxi
32-bit mode.....	xxi
3DNow!™ instructions	235
64-bit media programming.....	235
64-bit mode.....	xxi, 8

A

AAA instruction.....	56, 84
AAD instruction.....	56, 84
AAM instruction	56, 84
AAS instruction	56, 84
aborts	107
absolute address	19
ADC instruction.....	59
ADD instruction.....	59
addition.....	59
ADDPD instruction.....	201
ADDPS instruction	201
addressing	
absolute address	19
address size	21, 81, 88
branch address	82
canonical form	18
complex address.....	19
effective address.....	18
I/O ports.....	149, 246
IP-relative	19, 22
linear.....	13, 15

memory.....	16
operands.....	46, 149, 246
PC-relative	19, 22
RIP-relative.....	xxvii, 22
stack address	20
string address	20
virtual.....	13, 15
x87 stack.....	295
ADDSD instruction	201
ADDSS instruction.....	201
ADDSUBPD instruction	204
ADDSUBPS instruction	204
AF bit	39
affine ordering	158, 314
AH register	29, 30
AL register	29, 30
alignment	
128-bit media	150, 231
64-bit media	247
general-purpose.....	47, 126
AND instruction	67
ANDNPD instruction	212
ANDNPS instruction.....	212
ANDPD instruction.....	212
ANDPS instruction.....	212
arithmetic instructions	59, 177, 201, 261, 273, 327
ARPL instruction	85
array bounds	67
ASCII adjust instructions.....	56
auxiliary carry flag.....	39
AX register	29, 30

B

B bit	298
BCD data type	310
BCD digits.....	43
BH register.....	29, 30
biased exponent	xxi, 153, 159, 308, 316
binary-coded-decimal (BCD) digits	43
bit scan instructions.....	65
bit strings.....	44
bit test instructions.....	65
BL register	29, 30
BOUND instruction.....	67, 84
BP register	29, 30
BPL register.....	30
branch removal.....	139, 187, 240, 268

- branch-address displacements 82
- branches 94, 103, 126, 230
- BSF instruction 65
- BSR instruction 65
- BSWAP instruction 57
- BT instruction 65
- BTC instruction 65
- BTR instruction 65
- BTS instruction 65
- busy (B) bit 298
- BX register 29, 30
- byte ordering 16, 57
- byte registers 33
- C**
- C3–C0 bits 298
- cache 118
 - cachability 231
 - coherency 121
 - line 121
 - management 79, 123
 - pollution 122
 - prefetching 123
 - stale lines 125
- cache management instructions 79
- CALL instruction 72, 84, 97
- caller-save parameter passing 229
- canonical address form 18
- carry flag 39
- CBW instruction 54
- CDQ instruction 54
- CDQE instruction 54
- CF bit 39
- CH register 29, 30
- CL register 29, 30
- clamping 151
- CLC instruction 75
- CLD instruction 75
- clearing the MMX state 229, 253, 285
- CLFLUSH instruction 80
- CLI instruction 76
- CMC instruction 75
- CMOVcc instructions 49
- CMP instruction 64
- CMPPD instruction 209
- CMPPS instruction 209
- CMPS instruction 68
- CMPSB instruction 68
- CMPSD instruction 68, 209
- CMPSQ instruction 68
- CMPSW instruction 209
- CMPSW instruction 68
- CMPXCHG instruction 78
- CMPXCHG16B instruction 78
- CMPXCHG8B instruction 78
- COMISD instruction 211
- COMISS instruction 211
- commit xxii, 114
- compare instructions 64, 186, 208, 268, 277, 334
- compatibility mode xxii, 9
- complex address 19
- condition codes (C3–C0) 298
- conditional moves 49, 325
- constants 327
- control instructions (x87) 338
- control transfers 19, 69, 93
- control word 299
- CPUID instruction 79, 91, 215, 279, 343
- CQO instruction 54
- CR0.EM bit 305
- CVTDQ2PD instruction 169
- CVTDQ2PS instruction 169
- CVTPD2DQ instruction 196
- CVTPD2PI instruction 197, 272
- CVTPD2PS instruction 196
- CVTPI2PD instruction 170, 256
- CVTPI2PS instruction 169, 256
- CVTPS2DQ instruction 196
- CVTPS2PD instruction 195
- CVTPS2PI instruction 197, 272
- CVTSD2SI instruction 198
- CVTSD2SS instruction 196
- CVTSI2SD instruction 170
- CVTSI2SS instruction 170
- CVTSS2SD instruction 196
- CVTSS2SI instruction 198
- CVTTPD2DQ instruction 197
- CVTTPD2PI instruction 197, 272
- CVTTPS2DQ instruction 196
- CVTTPS2PI instruction 197, 272
- CVTTSD2SI instruction 198
- CVTTSS2SI instruction 198
- CWD instruction 54
- CWDE instruction 54
- CX register 29, 30
- D**
- DAA instruction 56, 84
- DAS instruction 56, 84
- data conversion instructions ... 54, 169, 195, 256, 272, 323
- data reordering instructions ... 171, 199, 257
- data transfer instructions. 49, 164, 190, 254,

- 323
- data types
 - 128-bit media..... 147
 - 128-bit media floating-point 158
 - 64-bit media..... 244
 - general-purpose 41
 - mismatched 229
 - x87 306, 314
- DAZ bit 145
- DE bit..... 144, 145, 220, 297, 347
- DEC instruction 61, 85
- decimal adjust instructions 56
- decrement..... 61
- default address size 21
- default operand size 33
- denormalized numbers..... 156, 312
- denormalized-operand exception (DE) . 220, 347
- dependencies 127
- DF bit..... 40
- DH register 29, 30
- DI register 29, 30
- DIL register 30
- direct far jump..... 70, 73
- direct referencing xxii
- direction flag..... 40
- displacements xxii, 20, 82
- DIV instruction 60
- division 60
- DIVPD instruction..... 205
- DIVPS instruction..... 205
- DIVSD instruction 205
- DIVSS instruction..... 205
- DL register 29, 30
- DM bit 145, 300
- dot product 138, 240
- double quadword xxiii
- double-extended-precision format 309
- double-precision format 153, 309
- doubleword..... xxii
- DX register 29, 30
- E**
- EAX register 29, 30
- eAX–eSP register..... xxix
- EBP register 29, 30
- EBX register..... 29, 30
- ECX register..... 29, 30
- EDI register 29, 30
- EDX register 29, 30
- effective address..... 18, 58
- effective address size xxiii
- effective operand size..... xxiii, 45
- EFLAGS register 29, 37
- eFLAGS register..... xxix
- EIP register..... 25
- eIP register xxix
- element xxiii
- EM bit..... 305
- EMMS instruction 253, 285
- empty..... 283, 302
- emulation (EM) bit 305
- endian byte-ordering xxxi, 16, 57
- ENTER instruction 52
- environment
 - x87 304, 340
- ES bit..... 298
- ESI register 29, 30
- ESP register 29, 30
- exception status (ES) bit 298
- exceptions xxiii, 105
 - #MF causes 282, 345
 - #XF causes 217
 - 128-bit media 215
 - 64-bit media 280
 - denormalized-operand (DE)..... 220, 347
 - general-purpose..... 105
 - inexact-result 221, 348
 - invalid-operation (IE) 219, 346
 - masked responses..... 224, 351
 - masking 224, 351
 - overflow (OE)..... 220, 348
 - post-computation..... 222, 349
 - precision (PE)..... 221, 348
 - pre-computation 222, 349
 - priority 222, 349
 - SIMD floating-point causes 217
 - stack fault (SF)..... 348
 - underflow (UE)..... 221, 348
 - unmasked responses 355
 - x87 344
 - zero-divide (ZE)..... 220, 348
- exit media state..... 253
- explicit integer bit 308
- exponent xxi, 153, 159, 308, 316
- extended functions 92
- external interrupts..... 106
- extract instructions 174, 259, 327
- F**
- F2XM1 instruction 333
- FABS instruction 331
- FADD instruction 328
- FADDP instruction..... 328

far calls	98	FMULP instruction	329
far jumps	96	FNINIT instruction	338
far returns	101	FNOP instruction	338
fault	106	FNSAVE instruction	270, 271, 286, 341
FBLD instruction	325	FPATAN instruction	332
FBSTP instruction	325	FPR0–FPR7 registers	294
FCMOVcc instructions	325	FPREM instruction	331
FCOM instruction	334	FPREM1 instruction	332
FCOMI instruction	334	FPTAN instruction	332
FCOMIP instruction	334	FPU control word	299
FCOMP instruction	334	FPU status word	295
FCOMPP instruction	334	FRNDINT instruction	331
FCOS instruction	332	FRSTOR instruction	271, 286, 341
FCW register	299	FS register	20
FDECSTP instruction	337	FSAVE instruction	270, 271, 286, 341
FDIV instruction	330	FSCALE instruction	333
FDIVP instruction	330	FSIN instruction	332
FDIVR instruction	330	FSINCOS instruction	332
FDIVRP instruction	330	FST instruction	323
feature detection	91	FSTP instruction	324
FEMMS instruction	253, 285	FSUB instruction	329
FERR# output signal	357	FSUBP instruction	329
FFREE instruction	338	FSUBR instruction	329
FICOM instruction	336	FSUBRP instruction	329
FICOMP instruction	336	FSW register	295
FIDIV instruction	330	FTST instruction	336
FIMUL instruction	330	FTW register	301
FINCSTP instruction	337	FUCOMx instructions	335
FINIT instruction	338	full	283, 302
FIST instruction	324	FXAM instruction	336
FISTP instruction	324	FXCH instruction	327
FISTTP instruction	324	FXRSTOR instruction	189, 271, 286, 341
FISUB instruction	329	FXSAVE instruction	189, 271, 286, 341
flags instructions	75	FTRACT instruction	327
FLAGS register	29, 37	FYL2X instruction	333
FLD instruction	323	FYL2XP1 instruction	333
FLD1 instruction	327	FZ bit	146
FLDL2E instruction	327	G	
FLDL2T instruction	327	general-purpose programming	27
FLDLG2 instruction	327	general-purpose registers (GPRs)	27
FLDLN2 instruction	327	GPR registers	27
FLDPI instruction	327	GS register	20
FLDZ instruction	327	H	
floating-point data types		HADDPD instruction	202, 203
128-bit media	152	HADDPs instruction	202
3DNow!™	249	hidden integer bit	153, 155, 308, 312
64-bit media	249	HSUBPD instruction	204
x87	307	HSUBPS instruction	204
flush	xxiii	I	
flush-to-zero (FZ) bit	146	I/O	110
FMUL instruction	329		

address space	111	locked	118
addresses	77, 111	memory ordering.....	116
instructions.....	76	prefixes.....	86, 214, 278, 342
memory-mapped	112	serializing.....	117
ports	77, 111, 149, 246	x87	321
privilege level	113	INSW instruction.....	77
IDIV instruction.....	60	INT instruction	74
IE bit	144, 219, 297, 346	integer bit	153, 155, 308, 311
IEEE 754 Standard	145, 154, 291, 307	integer data types	
IGN	xxiv	128-bit media	150
IGNNE# input signal	357	64-bit media	247
IM bit	145, 300	general-purpose.....	41
immediate operands.....	20, 46, 82	x87	309
implied integer bit.....	153, 308	interleave instructions.....	199, 258
IMUL instruction.....	60	interrupt vector.....	106
IN instruction	77	interrupts and exceptions	74, 105
INC instruction	61, 85	INTO instruction	74, 84
increment	61	invalid-operation exception (IE).....	219, 346
indefinite value		IOPL	113
floating-point.....	159, 317	IP register	25
integer.....	159, 317	IP-relative addressing	19, 22
packed-decimal	317	IRET instruction	74
indirect	xxiv	IRETD instruction.....	74
inexact-result exception... 145, 221, 297, 348		IRETQ instruction.....	74
infinity	157, 313	J	
infinity bit (Y).....	301	J bit.....	153, 308
initialization		Jcc instructions	70, 96
MCSR register	143	JMP instruction.....	69, 84
x87 control word	299	L	
XMM registers.....	142	LAHF instruction	76
inner product	138, 240	last data pointer	304
input/output (I/O)	110	last instruction pointer	303
INS instruction	77	last opcode.....	304
INSB instruction	77	LDDQU instruction.....	164
INSD instruction	77	LDMXCSR instruction.....	190
insert instructions.....	174, 259	LDS instruction	58, 84
instruction pointer.....	24	LEA instruction.....	58
instruction prefixes		LEAVE instruction.....	52
128-bit media.....	214	legacy mode	xxiv, 9
64-bit media.....	278	legacy x86	xxiv
general-purpose	86	LES instruction	58, 84
x87	342	LFENCE instruction	79
instruction set	4	LFS instruction.....	58
instruction-relative address.....	19	LGS instruction	58
instructions		limiting.....	151
128-bit media.....	129, 190	linear address	13, 15
64-bit media.....	251, 271	LOCK prefix	89
floating-point.....	132, 190, 242, 271, 291	LODS instruction	69
general-purpose	48	LODSB instruction.....	69
I/O.....	118	LODSD instruction.....	69
invalid in 64-bit mode.....	84	LODSQ instruction.....	69

- LODSW instruction 69
 logarithmic functions 333
 logarithms..... 327
 logical instructions 67, 188, 212, 269
 logical shift..... 63
 long mode xxiv, 7
 LOOPcc instructions..... 72
 LSB xxv
 lsb xxv
 LSS instruction 58
- M**
- mask..... xxv, 145, 300
 masked responses 224, 351
 MASKMOVDQU instruction..... 165, 255
 matrix operations 137, 239
 MAXPD instruction..... 210
 MAXPS instruction..... 210
 MAXSD instruction..... 210
 MAXSS instruction..... 210
 MBZ..... xxv
- memory
- addressing 16
 - hierarchy..... 118
 - management..... 14, 79
 - model 11
 - optimization 114
 - ordering 114
 - physical..... 13
 - segmented 12
 - virtual 11
 - weakly ordered..... 113
- memory management instructions 79
 memory-mapped I/O 76, 112
 MFENCE instruction..... 79
 MINPD instruction 210
 MINPS instruction..... 210
 MINS instruction..... 210
 MINSS instruction 210
 MMX registers 243
 MMX™ instructions 235
- modes
- 16-bit xxi
 - 32-bit xxi
 - 64-bit xxi, 8
 - compatibility xxii, 9
 - legacy xxiv, 9
 - long..... xxiv, 7
 - mode switches 34
 - operating 3, 7
 - protected xxvi, 9, 16, 94
 - real xxvi
 - real mode 10, 16
 - virtual-8086..... xxviii, 9, 16
- moffset xxv
 MOV instruction..... 49
 MOV segReg instruction 58
 MOVAPD instruction 191
 MOVAPS instruction 191
 MOVD instruction 49, 164, 254
 MOVDDUP instruction 191, 194
 MOVDQ2Q instruction 164, 254
 MOVDQA instruction 164
 MOVDQU instruction 164
 MOVHLPS instruction..... 191
 MOVHPD instruction..... 191
 MOVHPS instruction 191
 MOVLHPS instruction..... 191
 MOVLPD instruction 191
 MOVLPS instruction 191
 MOVMSKPD instruction 55, 195
 MOVMSKPS instruction..... 55, 195
 MOVNTDQ instruction 165, 255
 MOVNTI instruction 49
 MOVNTPD instruction 194
 MOVNTPS instruction 194
 MOVNTQ instruction..... 255
 MOVQ instruction 164, 254
 MOVQ2DQ instruction 164, 254
 MOVS instruction..... 68
 MOVSB instruction 68
 MOVSD instruction..... 68, 191
 MOVSHDUP 194
 MOVSHDUP instruction 191
 MOVSLDUP 194
 MOVSLDUP instruction 191
 MOVSQ instruction..... 68
 MOVSS instruction 191
 MOVSW instruction 68
 MOVSX instruction..... 49
 MOVUPD instruction..... 191
 MOVUPS instruction 191
 MOVZX instruction..... 49
- MSB xxv
 msb xxv
 MSR..... xxx
 MUL instruction..... 60
 MULPD instruction..... 205
 MULPS instruction 205
 MULSD instruction..... 205
 MULSS instruction 205
 multiplication 60
 multiply-add..... 138, 239

N

NaN 157, 313
near branches 104
near calls 98
near jumps 96
near returns 101
NEG instruction 59
NMI interrupt 107
non-temporal data 122
non-temporal moves 165, 194, 255
non-temporal stores 125, 231
NOP instruction 80
normalized numbers 155, 156, 311, 312
not a number (NaN) 157, 313
NOT instruction 67
number encodings
 128-bit media floating-point 158
 x87 314
number representation
 128-media floating-point 155
 64-bit media floating-point 249
 x87 floating-point 310

O

octword xxv
OE bit 145, 220, 297, 348
OF bit 40
offset xxv
OM bit 145, 300
opcode 304
operand size 33, 44, 82, 85, 88, 126, 230, 287
operands
 128-bit media 147
 64-bit media 244
 addressing 46
 general-purpose 41
 x87 306
operating modes 3, 7
OR instruction 67
ordered compare 212, 335
ORPD instruction 213
ORPS instruction 213
OSXMMEXCPT bit 218
OUT instruction 77
OUTS instruction 77
OUTSB instruction 77
OUTSD instruction 77
OUTSW instruction 77
overflow xxvi
overflow exception (OE) 220, 348
overflow flag 40

P

pack instructions 171, 257
packed xxvi, 131, 237
packed BCD digits 43
packed-decimal data type 310
PACKSSDW instruction 171, 257
PACKSSWB instruction 171, 257
PACKUSB instruction 171, 257
PADDB instruction 177, 261
PADDD instruction 177, 261
PADDQ instruction 177, 261
PADDSB instruction 177, 262
PADDSW instruction 177, 262
PADDUSB instruction 177
PADDUSW instruction 177
PADDW instruction 177, 261
PAND instruction 188, 269
PANDN instruction 188, 269
parallel operations 130, 237
parameter passing 229
parity flag 39
partial remainder 331
PAVGB instruction 182, 265
PAVGUSB instruction 266
PAVGW instruction 182, 265
PC field 300, 319
PCMPEQB instruction 186, 268
PCMPEQD instruction 186, 268
PCMPEQW instruction 186, 268
PCMPGTB instruction 186, 268
PCMPGTD instruction 186, 268
PCMPGTW instruction 186, 268
PC-relative addressing 19, 22
PE bit 145, 221, 297, 348
performance considerations
 128-bit media 230
 64-bit media 287
 general-purpose 125
 x87 359
PEXTRW instruction 174, 259
PF bit 39
PF2ID instruction 272
PF2IW instruction 272
PFACC instruction 275
PFADD instruction 273
PFCMPEQ instruction 277
PFCMPGE instruction 277
PFCMPGT instruction 277
PFMAX instruction 277
PFMIN instruction 277
PFMUL instruction 274

PFNACC instruction	275	REX	30
PFPNACC instruction	275	x87	342
PFRCP instruction	276	priority of exceptions	222, 349
PFRCPIT1 instruction	276	privilege level	94, 109
PFRCPIT2 instruction	276	procedure calls	97
PFRSQIT1 instruction	277	procedure stack	95
PFRSQRT instruction	277	processor features	91
PFSUB instruction	274	processor identification	79
PFSUBR instruction	274	processor vendor	92
physical memory	13	processor version	92
Pi	327, 333	program order	114
PI2FD instruction	256	programming model	
PI2FW instruction	256	128-bit media	129
PINSRW instruction	174, 259	64-bit media	235
PM bit	145, 300	general-purpose	27
PMADDWD instruction	181, 264	x87	291
PMAXSW instruction	188, 269	protected mode	xxvi, 9, 16
PMAXUB instruction	188, 269	PSADBW instruction	183, 266
PMINSW instruction	188, 269	pseudo-denormalized numbers	313
PMINUB instruction	188, 269	pseudo-infinity	311
PMOVMSKB instruction	168, 256	pseudo-NaN	311
PMULHRW instruction	263	PSHUFD instruction	175
PMULHUW instruction	179, 263	PSHUFHW instruction	175
PMULHW instruction	179, 263	PSHUFLW instruction	175
PMULLW instruction	179, 263	PSHUFW instruction	260
PMULUDQ instruction	179, 264	PSLLD instruction	184, 266
pointers	22	PSLLDQ instruction	184
POP instruction	52, 84	PSLLQ instruction	184, 266
POP segReg instruction	58	PSLLW instruction	184, 266
POPA instruction	52, 84	PSRAD instruction	186, 267
POPAD instruction	52, 84	PSRAW instruction	186, 267
POPF instruction	75	PSRLD instruction	185, 267
POPFD instruction	75	PSRLDQ instruction	185
POPFQ instruction	75	PSRLQ instruction	185, 267
POR instruction	189, 270	PSRLW instruction	185, 267
post-computation exceptions	222, 349	PSUBB instruction	178, 262
precision control (PC) field	300, 319	PSUBD instruction	178, 262
precision exception (PE)	221, 348	PSUBQ instruction	178, 262
pre-computation exceptions	222, 349	PSUBSB instruction	178, 263
PREFETCH instruction	80, 124	PSUBSW instruction	178, 263
prefetching	123, 126, 231	PSUBUSB instruction	178
PREFETCHlevel instruction	79, 123	PSUBUSW instruction	178
PREFETCHNTA instruction	124	PSUBW instruction	178, 262
PREFETCHT0 instruction	124	PSWAPD instruction	261
PREFETCHT1 instruction	124	PUNPCKHBW instruction	172, 258
PREFETCHT2 instruction	124	PUNPCKHDQ instruction	172
PREFETCHW instruction	80, 124	PUNPCKHQDQ instruction	172
prefixes		PUNPCKHWD instruction	172
128-bit media	214	PUNPCKLBW instruction	172, 258
64-bit media	278	PUNPCKLDQ instruction	172, 258
general-purpose	86	PUNPCKLQDQ instruction	172

PUNPCKLWD instruction.....	172, 258	IP.....	25
PUSH instruction.....	52, 84	MMX.....	243
PUSHA instruction.....	52, 85	r8–r15	xxx
PUSHAD instruction.....	52, 85	rAX–rSP	xxx
PUSHF instruction	75	rFLAGS	xxxi
PUSHFD instruction	75	RIP	25
PUSHFQ instruction	75	rIP	xxxi, 25
PXOR instruction	189, 270	segment.....	20
Q		x87 control word.....	299
QNaN	157, 314	x87 last data pointer.....	304
quadword.....	xxvi	x87 last opcode.....	304
quiet NaN (QNaN).....	157, 314	x87 last-instruction pointer.....	303
R		x87 physical	294
R8B–R15B registers.....	30	x87 stack.....	294
R8D–R15D registers	30	x87 status word.....	295
r8–r15.....	xxx	x87 tag word.....	301
R8–R15 registers.....	30	XMM.....	141
R8W–R15W registers	30	relative	xxvi
range of values		remainder	331
128-bit media.....	153	REP prefix	90
64-bit media.....	247, 250	REPE prefix.....	90
x87.....	309	repeat prefixes	90, 127
RAX register	30	REPNE prefix.....	90
rAX–rSP.....	xxx	REPZ prefix	90
RAZ.....	xxvi	reserved.....	xxvi
RBP register	30	reset.....	143
rBP register	23	restoring state	358
RBX register.....	30	RET instruction.....	74, 100
RC field	146, 300, 320	revision history.....	xvii
RCL instruction	62	REX prefixes	8, 30, 90
RCPPS instruction.....	208	RFLAGS register	30, 37
RCPSS instruction.....	208	rFLAGS register	xxxi
RCR instruction.....	62	RIP register	25, 30
RCX register	30	rIP register.....	xxxi, 25
RDI register.....	30	RIP-relative addressing	xxvii, 22
RDX register	30	ROL instruction.....	62
read order	115	ROR instruction	62
real address mode. See real mode		rotate instructions.....	61
real mode.....	xxvi, 10, 16	rounding	
real numbers	155, 311	128-bit media.....	146, 160
reciprocal estimation.....	208, 276	64-bit media	249, 251
reciprocal square root	208, 276	x87	300, 320, 331
register extensions	1, 3, 8	rounding control (RC) field.....	146, 300, 320
registers	3	RSI register.....	30
128-bit media.....	141	RSP register.....	30, 97
64-bit media.....	243	rSP register	23
eAX–eSP	xxix	RSQRTPS instruction	208
eFLAGS.....	xxix	RSQRTSS instruction	208
EIP.....	25	S	
eIP	xxix	SAHF instruction	76
extensions.....	1, 3		

SAL instruction.....	62	SQRTSD instruction	206
SAR instruction	62	SQRTSS instruction	206
saturation		square root.....	206, 276, 332
128-bit media.....	151	SSE	xxvii, 129, 235
64-bit media.....	248	SSE2	xxvii, 129, 235
saving state.....	189, 228, 270, 285, 358	SSE3	xxvii, 129, 235
SBB instruction	59	ST(0)–ST(7) registers	294
scalar product	138, 240	stack	95, 228
SCAS instruction	68	address	20
SCASB instruction.....	68	allocation	127
SCASD instruction.....	68	frame	23, 52
SCASQ instruction.....	68	operand size.....	95
SCASW instruction.....	68	operations	52
scientific programming	131	pointer.....	23, 95
segment override	89	x87 stack fault	348
segment registers.....	20	x87 stack management	337
segmented memory	12	x87 stack overflow.....	348
self-modifying code	122	x87 stack underflow.....	348
semaphore instructions.....	78	stack fault (SF) exceptions.....	348
set.....	xxvii	standard functions	92
SETcc instructions.....	65	state saving.....	189, 228, 270, 285, 358
SF bit	40, 297, 348	status word.....	295
SFENCE instruction.....	79	STC instruction	75
shift instructions.....	61, 184, 266	STD instruction	75
SHL instruction.....	62	STI instruction.....	76
SHLD instruction.....	63	sticky bits.....	xxviii, 144, 296
SHR instruction	63	STMXCSR instruction	190
SHRD instruction	63	STOS instruction	69
shuffle instructions.....	175, 200, 260	STOSB instruction.....	69
SHUFPS instruction	200	STOSD instruction	69
SHUFPS instruction.....	200	STOSQ instruction	69
SI register	29, 30	STOSW instruction	69
sign	150, 159, 247, 316, 331	streaming store.....	135, 165, 194, 231, 255
sign extension	54	string address	20
sign flag	40	string instructions.....	68, 77
sign masks	55	strings.....	44
signaling NaN (SNaN)	157, 314	SUB instruction.....	59
significand.....	153, 159, 308, 316	SUBPD instruction.....	203
SIL register.....	30	SUBPS instruction	202, 203
SIMD floating-point exceptions	217	SUBSD instruction	203
SIMD operations.....	131, 237	SUBSS instruction.....	203
single-instruction, multiple-data (SIMD) ...	5	subtraction.....	59
single-precision format.....	153, 249, 308	sum of absolute differences	266
SNaN	157, 314	swap instructions.....	260
software interrupts.....	74, 106	SYSCALL instruction	103
SP register	29, 30	SYSECALL instruction.....	81
spatial locality.....	122	SYSENTER instruction	81, 85, 103
speculative execution.....	115	SYSEXIT instruction	81, 85, 103
SPL register.....	30	SYSRET instruction.....	81, 103
SQRTPD instruction.....	206	system call and return instructions..	81, 103
SQRTPS instruction	206		

T

tag bits 282, 301
tag word 301
task switch 100
task-state segment (TSS) 100
temporal locality 122
TEST instruction 64
test instructions 64, 334
tiny numbers 156, 220, 221, 312, 347
TOP field 294, 298
top-of-stack pointer (TOP) 282, 294, 298
transcendental instructions 332
trap 107
trigonometric functions 332
TSS xxviii

U

UCOMISD instruction 211
UCOMISS instruction 211
UE bit 145, 221, 297, 348
ulp 161, 321
UM bit 145, 300
underflow xxviii, 348
underflow exception (UE) 221, 348
unit in the last place (ulp) 161, 321
unmask 145, 300
unmasked responses 227, 355
unnormal numbers 311
unordered compare 212, 335
unpack instructions 172, 199, 258
UNPCKHPD instruction 199
UNPCKHPS instruction 199
UNPCKLPD instruction 199
UNPCKLPS instruction 199
unsupported number types 311

V

vector xxviii, 106
vector operations 131, 237
virtual address 13, 15
virtual memory 11
virtual-8086 mode xxviii, 9, 16

W

weakly ordered memory 113
write buffers 120
write combining 116
write order 116

X

x87 control word register 299
x87 environment 304, 340
x87 floating-point programming 291
x87 status word register 295

x87 tag word register 301
XADD instruction 78
XCHG instruction 78
XLAT instruction 55
XMM registers 141
XOR instruction 67
XORPD instruction 213
XORPS instruction 213

Y

Y bit 301

Z

ZE bit 145, 220, 297, 348
zero 157, 313
zero flag 40
zero-divide exception (ZE) 220, 348
zero-extension 20, 33, 84
ZF bit 40
ZM bit 145, 300

